



koberg

COLLECTION 2023



We invite you to discover our
innovative collection for 2023
and our drivers to inspire as
many people as possible to
bring today's nature into their
daily lives. Enjoy!



GET INSPIRED

| | |
|---------------------|----|
| give room to nature | 7 |
| innovations 2023 | 14 |
| impactful media | 23 |

OUTDOOR

| | |
|----------------------|-----|
| greensense aqua care | 38 |
| vivo next | 44 |
| vibia | 48 |
| greenville | 72 |
| loft urban | 82 |
| corsica | 98 |
| barcelona | 106 |
| algarve | 118 |
| universal saucers | 122 |
| green basics outdoor | 136 |

CARE & GROW

| | |
|----------------------------|-----|
| green basics grow your own | 164 |
| noa grow table | 196 |
| grow your own indoor | 198 |
| light care | 204 |

EXCLUSIVES

| | |
|------|-----|
| pure | 210 |
|------|-----|

INDOOR

| | |
|----------------------|-----|
| the ocean collection | 224 |
| vibes fold | 228 |
| b.for soft | 236 |
| b.for studio | 244 |
| b.for original | 248 |
| b.for rock | 256 |
| brussels | 260 |
| brussels diamond | 272 |
| brussels orchid | 280 |
| self-watering insert | 286 |
| floorprotector | 292 |

WATERING CANS & SPRAYERS

| | |
|---------------------------|-----|
| brussels | 300 |
| b.for soft | 302 |
| aquarius | 304 |
| plunge | 306 |
| aqua care | 308 |
| green basics watering can | 310 |

CHRISTMAS

| | |
|---------|-----|
| nordman | 317 |
| oslo | 317 |









Nature has given us everything. From the air we breathe, to the food we eat. We're not apart from nature – we're part of it. Its well-being is our well-being. And when it flourishes, we flourish. It's our dream to build a greener, better world – and encourage others to join us.

So let's Learn from nature – be amazed by it, inspired by it, and let's share our knowledge with others, so we can grow, together. Let's Love nature, surround ourselves with it, and bring it back into our daily lives. And let's Return the gifts the earth has shared with us. Let's be inspired by the cyclicity of nature, and repair, reuse and recycle. Because small actions today... cause big changes tomorrow.

That's why it is our mission to bring today's nature into people's daily lives and stimulate people to work together with nature. That can be in the comfort of your own garden or home but also in your neighbourhood. Did you know? A green neighbourhood connects local residents and stimulates biodiversity in the city. This makes people and nature happy.

We are encouraging people to surround themselves and their neighbourhood with greenery together. Let's work together, and step-by-step, we'll create a world where nature and people can blossom.



THE BENEFITS OF *nature*

It makes you happier, it makes you
feel healthier and it boosts your energy.





WE
LOVE
TO *innovate*





Plants as a hobby

More and more people see plants as a hobby instead of just an object in their home or garden. This results in a more active attitude towards keeping plants, gardening and growing and harvesting. Not only because it is fun to grow your own vegetables and herbs, but also because it is tasty and healthy. Moreover, it is better for the environment to get vegetables from your own garden as much as possible.



Personal wellness

Personal wellness became more important than ever within covid time. Never ever before the separation between work and private life was so thin and a lot of leisure activities were not possible anymore in covid time. People rediscovered the pleasure of being in nature and feel that they can recharge themselves with plants. Plants bring feelings of vitality and improve the state of mind. An environment that includes natural elements and plants brings a positive outlook on life and boosts energy.

Sustainability

We are fully dedicated to take care of our planet for current and future generations. On our way to use 100% recycled plastic we think about the entire life cycle of our products and capture circularity in our design:

- Using sustainable resources
- No waste during the entire process
- Reusable / Recyclable



THEMES 2023

Plantcare

Learning to care for plants is challenging and might be a worry that keeps people from buying plants. Especially the younger generation is trying their hand at plant care as they set up homes of their own. Looking for plant care solutions for convenience and to avoid insecurities or compensate lack of knowledge.

We take the next step in worry free plant enjoyment since the consumer is seeking for convenience. We offer easy solutions to keep plants alive.



INSPIRATION FOR OUR INNOVATIONS

Watercare

The excesses and shortages of water has led to practices such as rainwater harvesting and rainwater conservation. More and more people are looking for smart water management solutions. The use of a rainbarrel will provide an alternative to using tap water for watering lawns, flower gardens and houseplants. It will help reduce peak water demands during the summer months. And it will save money.





**VIBIA CAMPANA
BALCONY TROUGH
SIZES 50 - 70CM**

Further extending the succesful vibia campana product family with balcony troughs with integrated saucer to offer plants a water reservoir. In 2 sizes, with and without balcony racks. The high quality, its rounded shape, soft texture and friendly colours make it a great offer in the midsegment.



personal wellness

2

**VIBIA CAMPANA
DRAINPIPE CLICKER**

This year, we introduce a vibia campana drainpipe clicker. The perfect concept to utilise unused outdoor surfaces, like drainpipes and turn it into a lush oasis. Now with a redesigned universal hanging system, applicable on all common drainpipe sizes 68-100mm. The high quality of the vibia campana products, its rounded shape, soft texture and friendly colours make sure this is a great offer in the mid-segment. Offering more soil capacity for plants to grow healthy.

sustainability

3



**GREEN BASICS
GROWPOTS SQUARE ALL-IN-1
SIZES 15 - 20 - 25 - 30 - 35CM
& GROW TRAYS ALL-IN-1
SIZES 32 - 39CM**

Tiny growgarden facilitating growing your own vegetables, herbs and fruit. With integrated saucer, which is easy to water via the spout, and including a grow house for an optimal growth climate and protection.

our inspiring INNOVATIONS

**GREEN BASICS
RAINBARREL PLUS
SIZES 110 - 200LTR**

The new rainbarrel plus offers all consumers the opportunity to save water in a sustainable way, whether they have a small or a large garden. The rainbarrels have a broad appealing design, include a tap and a stand, in order to optimally use the collected water and a planter on top. Made out of 100% recycled plastic and of long-lasting quality because of its frost and UV-resistance.

**GREEN BASICS
RAINBARREL DIVERTER**

To connect a rainbarrel to the drainpipe, this diverter is easy to install as it fits to all common drainpipes sizes, round and square.



AND MORE *innovations*

NOA GROW TABLE

A complete new grow table including a grow house and all convenient product features you can think of. Supporting consumers to grow their own fruit, herbs and vegetables, even on a small outdoor space. The integrated water reservoir and water filling meter help to water your plants in a correct way, the tray offers additional space for accessories and the detachable legs and plug are convenient to clean up after the growing season. In 3 beautiful colours with a powdered texture.



B. FOR SWING

An innovative and elegant plant hanging concept to vertically green up your interior. Including high quality, sustainable robes in different lengths so you can hang up 1 pot or combine 2 pots. Easy to water via the waterspout in the pot shape or combine it with the self-watering insert.



THE OCEAN COLLECTION SIZES 14 - 16 - 18 - 22CM

Beautiful indoor pots with marble look made from fishing nets and robes which are preventively collected so they don't pollute the oceans and the seas. Each pot has a unique look.

sustainability

3



plants as a hobby

1

GROW YOUR OWN INDOOR BOUNCY BASIL

A fun and convenient way to keep your basil plant healthy. Beautiful designed with a large water reservoir to prevent your basil plant from drying out.

AMAZING AVOCADO

Offering consumers the possibility to grow their own avocado plant from a pit. Either with the pot, which includes a water reservoir, or with the floater.

MAGIC MICROGREENS

The beautiful design is an eyecatcher in your kitchen and makes growing your own microgreens very easy.



THE
POWER
OF colour

New trends in the collection 2023 are based on 4 style trends:

SUSTAINABLE HEDONISM



This style trend is about seeking peace and balance in an easy and comfortable way. This is reflected in the use of balanced colours like the new colours: stone green, toffee terra and soft terra.

COLOURS

367

754

755

ODE TO NATURE



More and more it dawns on us that we are not separate from nature, but that we are one with nature. In terms of colours, this leads to a natural colour palette of greens and browns, like the new colours moss green and clay brown.

COLOURS

368

768

VINTAGE VOLKLORE



More respect for the lifespan of a product is related to this style trend and is found in colours that expresses this feeling, like the new colour sorbet green.

COLOURS

369

EXISTENTIAL POWER



Nature also has an enormous, fascinating power which is reflected in diverse colour palette like the new colour dove blue.

COLOURS

541



We are impactful by creating with nature in mind: our collection is sustainably produced, made out of recycled plastic and recyclable. And of course, produced with renewable energy from our own windmill. As your most sustainable partner we are always aiming to do more and it is our ambition to make the world a better and greener place for current and future generations. Will you join us?



and ... we are proud of our 2,000,000 bees producing our own honey in our backyard.



THE BEAUTY OF WASTE

designer pots made out of **recycled** plastics









LET'S BE
RELEVANT



PRODUCT INNOVATIONS

The Dutch design team is dedicated to surprise with unique and breakthrough innovations, inspired by nature and on-top-of evolving consumer trends, and uses a revolutionary weather and UV protection technology. This allows our products a long-lasting colour. Best quality guaranteed.



SUPPLY CHAIN INNOVATIONS





elho



MADE WITH RECYCLED MATERIALS

elho.com 052 208282









LET'S
GROW
TOGETHER







elio



outdoor
COLLECTION



GREENSENSE AQUA CARE

Need some assistance with taking care of your plants' water needs? The greensense aqua care makes it easier than ever before with the integrated water reservoir which can be filled directly from the water inlet. The water level is easy to read with the indicator. This designer pot is made with 100% recycled plastics and finished with a concrete-like texture.

NICE THINGS TO KNOW ABOUT THE FAMILY

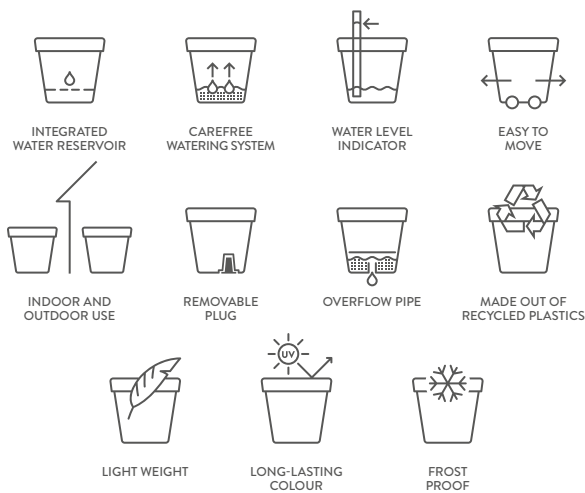

Robust planters in 2 different shapes



round 30, 35 & 43cm



square 30 & 38cm

CONCRETE-LIKE TEXTURE

colours

311

440

768

new



WATCH THE GREENSENSE AQUA CARE PRODUCT VIDEO



greensense aqua care COLLECTION

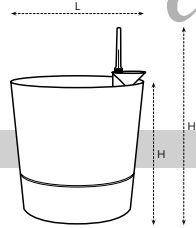

GREENSENSE AQUA CARE ROUND

NEW
COLOUR



MADE OUT OF RECYCLED PLASTICS



WATER LEVEL INDICATOR



CAREFREE WATERING SYSTEM



EASY TO MOVE



REMOVABLE PLUG



OVERFLOW PIPE

| description | | | | | | | additional information |
|---------------------------------|------|--------------|------|------|---|-----|--------------------------------------------------------------------------|
| greensense aqua care round 30cm | 29.5 | 29.1 / 41.3* | 13.0 | 0.73 | 4 | 128 | waterreservoir capacity of 2.8 liter, *measurements including watermeter |

| | art. number | | ean code | | art. number | | ean code | | art. number | | ean code |
|-----|-------------------|---|----------|-----|-------------------|---|----------|-----|-------------------|---|----------|
| 311 | 31 029 030 311 00 | 4 | | 440 | 31 029 030 440 00 | 4 | | 768 | 31 029 030 768 00 | 4 | |

| description | | | | | | | additional information |
|---------------------------------|------|--------------|------|------|---|-----|--------------------------------------------------------------------------|
| greensense aqua care round 35cm | 34.5 | 34.1 / 46.0* | 21.0 | 1.09 | 4 | 112 | waterreservoir capacity of 4.7 liter, *measurements including watermeter |

| | art. number | | ean code | | art. number | | ean code | | art. number | | ean code |
|-----|-------------------|---|----------|-----|-------------------|---|----------|-----|-------------------|---|----------|
| 311 | 31 033 035 311 00 | 4 | | 440 | 31 033 035 440 00 | 4 | | 768 | 31 033 035 768 00 | 4 | |

| description | | | | | | | additional information |
|---------------------------------|------|--------------|------|------|---|----|--------------------------------------------------------------------------|
| greensense aqua care round 43cm | 43.0 | 42.5 / 54.4* | 39.0 | 1.86 | 3 | 48 | waterreservoir capacity of 9.5 liter, *measurements including watermeter |

| | art. number | | ean code | | art. number | | ean code | | art. number | | ean code |
|-----|-------------------|---|----------|-----|-------------------|---|----------|-----|-------------------|---|----------|
| 311 | 31 041 043 311 00 | 3 | | 440 | 31 041 043 440 00 | 3 | | 768 | 31 041 043 768 00 | 3 | |

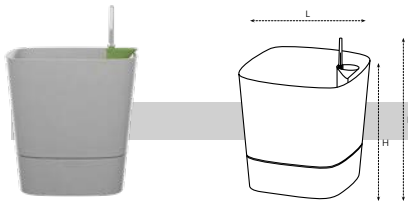

GREENSENSE AQUA CARE SQUARE

NEW COLOUR



MADE OUT OF RECYCLED PLASTICS



WATER LEVEL INDICATOR



CAREFREE WATERING SYSTEM



EASY TO MOVE



REMOVABLE PLUG



OVERFLOW PIPE

| description | | | | | | | additional information | | | | | | | | | | | | |
|----------------------------------|--|--|--|--|--|--|------------------------|--------------|------|------|---|--------------------------------------------------------------------------|--|--|--|--|--|--|--|
| greensense aqua care square 30cm | | | | | | | | | | | | waterreservoir capacity of 3.5 liter, *measurements including watermeter | | | | | | | |
| | | | | | | | 29.5 x 29.5 | 30.2 / 41.3* | 15.0 | 0.84 | 4 | 128 | | | | | | | |

| | art. number | | ean code | | art. number | | ean code | | art. number | | ean code |
|-----|-------------------|---|-----------------|-----|-------------------|---|-----------------|-----|-------------------|---|-----------------|
| 311 | 31 129 030 311 00 | 4 | | 440 | 31 129 030 440 00 | 4 | | 768 | 31 129 030 768 00 | 4 | |
| | | | 8 711904 497422 | | | | 8 711904 497453 | | | | 8 711904 522827 |

| description | | | | | | | additional information | | | | | | | | | | | | |
|----------------------------------|--|--|--|--|--|--|------------------------|--------------|------|------|---|------------------------------------------------------------------------|--|--|--|--|--|--|--|
| greensense aqua care square 38cm | | | | | | | | | | | | waterreservoir capacity of 8 liter, *measurements including watermeter | | | | | | | |
| | | | | | | | 38.0 x 38.0 | 38.9 / 50.8* | 31.0 | 1.58 | 3 | 72 | | | | | | | |

| | art. number | | ean code | | art. number | | ean code | | art. number | | ean code |
|-----|-------------------|---|-----------------|-----|-------------------|---|-----------------|-----|-------------------|---|-----------------|
| 311 | 31 139 038 311 00 | 3 | | 440 | 31 139 038 440 00 | 3 | | 768 | 31 139 038 768 00 | 3 | |
| | | | 8 711904 497507 | | | | 8 711904 497538 | | | | 8 711904 522865 |

greensense aqua care INSTORE PRESENTATIONS



GREENSENSE AQUA CARE ROUND 30CM DISPLAY

- inspire your shopper, present this unique family on a high-traffic location in your store



| art. number | size lxd | | m ² | product | | qty. | | qty. | ean code |
|-------------------|----------|-----|----------------|---------------------------------|-----|------|-----|------|-----------------|
| 31 000 001 901 10 | 60 x 80 | 100 | 0.48 | greensense aqua care round 30cm | 311 | 14 | 440 | 14 | 8 711904 508708 |



GREENSENSE AQUA CARE ROUND ISLAND PRESENTATION

- inspire your shopper, present this unique family on a high-traffic location in your store

NEW COLOUR



| art. number | size lxd | m ² | product | | qty. | | qty. | ean code |
|-------------------|----------|----------------|---------------------------------|-----|------|-----|------|-----------------|
| 31 000 001 902 10 | 120 x 80 | 0.96 | greensense aqua care round 30cm | 311 | 7 | 440 | 7 | 8 711904 508722 |
| | | | greensense aqua care round 35cm | 311 | 6 | 440 | 6 | |
| | | | greensense aqua care round 43cm | 311 | 4 | 440 | 4 | |

| art. number | size lxd | m ² | product | | qty. | | qty. | | qty. | ean code |
|-------------------|----------|----------------|---------------------------------|-----|------|-----|------|-----|------|-----------------|
| 31 000 001 903 10 | 120 x 80 | 0.96 | greensense aqua care round 30cm | 311 | 7 | 440 | 7 | 768 | 7 | 8 711904 523886 |
| | | | greensense aqua care round 35cm | 311 | 6 | 440 | 6 | 768 | 6 | |



GREENSENSE AQUA CARE SQUARE 30 & 38CM ISLAND PRESENTATION

- create awareness, ideal second placement for a unique product family



| art. number | size lxd | m ² | product | | qty. | | qty. | ean code |
|-------------------|----------|----------------|----------------------------------|-----|------|-----|------|-----------------|
| 31 100 001 902 10 | 120 x 80 | 0.96 | greensense aqua care square 30cm | 311 | 12 | 440 | 12 | 8 711904 508739 |
| | | | greensense aqua care square 38cm | 311 | 7 | 440 | 8 | |



GREENSENSE AQUA CARE ROUND













VIVO NEXT

Meet the new vivo. This next generation is improved in many ways. A total new construction, which is stronger than before, contains a large and smart water reservoir and is now made with recycled material. These beautiful cube shaped pots are easy-to-move thanks to the integrated wheels. A plug makes these pots the ideal dividers for both outdoor and indoor spaces. Newly added in the range are the smaller sizes of 30cm square and 30x60cm rectangle.



NICE THINGS TO KNOW ABOUT THE FAMILY

-  INTEGRATED WATER RESERVOIR
-  CAREFREE WATERING SYSTEM
-  EASY TO MOVE
-  REMOVABLE PLUG
-  INDOOR AND OUTDOOR USE
-  OVERFLOW PIPE
-  MADE OUT OF RECYCLED PLASTICS
-  LIGHT WEIGHT
-  LONG-LASTING COLOUR
-  FROST PROOF



square

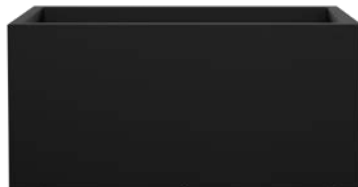

long

IMPROVED DESIGN

Available now!



colours

150

431

433

AVAILABLE SIZES

30x30, 40x40,
30x60 & 40x80cm

vivo next COLLECTION

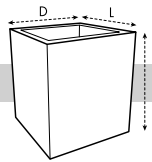

VIVO NEXT SQUARE



| description | | | | | | | additional information |
|-----------------------|-------------|------|------|------|---|----|---------------------------------------|
| vivo next square 30cm | 29.5 x 29.5 | 24.9 | 12.0 | 1.56 | 1 | 56 | water reservoir capacity of 3.5 liter |

| | art. number | | ean code | | art. number | | ean code | | art. number | | ean code |
|-----|-------------------|---|----------|-----|-------------------|---|----------|-----|-------------------|---|----------|
| 150 | 16 229 300 150 00 | 1 | | 431 | 16 229 300 431 00 | 1 | | 433 | 16 229 300 433 00 | 1 | |

| description | | | | | | | additional information |
|-----------------------|-------------|------|------|------|---|----|---------------------------------------|
| vivo next square 40cm | 39.0 x 39.0 | 37.9 | 28.0 | 1.67 | 1 | 30 | water reservoir capacity of 8.5 liter |

| | art. number | | ean code | | art. number | | ean code | | art. number | | ean code |
|-----|-------------------|---|----------|-----|-------------------|---|----------|-----|-------------------|---|----------|
| 150 | 16 248 390 150 00 | 1 | | 431 | 16 248 390 431 00 | 1 | | 433 | 16 248 390 433 00 | 1 | |

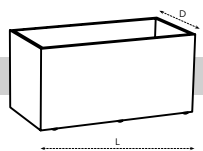
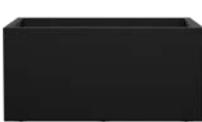

VIVO NEXT LONG



| description | | | | | | | additional information |
|---------------------|-------------|------|------|------|---|----|-------------------------------------|
| vivo next long 60cm | 59.0 x 29.5 | 29.2 | 27.0 | 1.56 | 1 | 28 | water reservoir capacity of 8 liter |

| | art. number | | ean code | | art. number | | ean code | | art. number | | ean code |
|-----|-------------------|---|----------|-----|-------------------|---|----------|-----|-------------------|---|----------|
| 150 | 16 429 600 150 00 | 1 | | 431 | 16 429 600 431 00 | 1 | | 433 | 16 429 600 433 00 | 1 | |

| description | | | | | | | additional information |
|---------------------|-------------|------|------|------|---|----|--------------------------------------|
| vivo next long 80cm | 78.0 x 39.0 | 37.9 | 63.0 | 2.68 | 1 | 15 | water reservoir capacity of 18 liter |

| | art. number | | ean code | | art. number | | ean code | | art. number | | ean code |
|-----|-------------------|---|----------|-----|-------------------|---|----------|-----|-------------------|---|----------|
| 150 | 16 438 800 150 00 | 1 | | 431 | 16 438 800 431 00 | 1 | | 433 | 16 438 800 433 00 | 1 | |

vivo next INSTORE PRESENTATIONS



VIVO NEXT INSTORE PRESENTATION

- let's seduce your shopper, stimulate the buying impulse



| art. number | description | size lxd | h | m ² | | ean code |
|-------------------|------------------------------------------|-----------|----|----------------|---|-----------------|
| 97 000 000 986 00 | double pallet cover waterproof 120x160cm | 120 x 160 | 15 | 1.92 | 1 | 8 711904 509163 |

PRODUCTS (CONTENT FOR INSTORE PRESENTATION)

| art. number | product | qty. | qty. | qty. | ean code | | | |
|-------------------|-----------------------|------|------|------|----------|-----|---|-----------------|
| 16 000 001 902 10 | vivo next square 30cm | 150 | 8 | 431 | 4 | 433 | 8 | 8 711904 509095 |
| | vivo next long 60cm | 150 | 7 | 431 | 4 | 433 | 7 | |

| art. number | product | qty. | qty. | qty. | ean code | | | |
|-------------------|-----------------------|------|------|------|----------|-----|---|-----------------|
| 16 000 001 901 10 | vivo next square 40cm | 150 | 5 | 431 | 4 | 433 | 5 | 8 711904 509088 |
| | vivo next long 80cm | 150 | 5 | 431 | 4 | 433 | 5 | |



VIBIA CAMPANA BALCONY

This family has a classic but contemporary look with its slightly rounded body, still elegant and perfectly suited to voluptuous and outgoing plants. Made with a rough, high-quality texture, available in a range of soft, cheerful, and on-trend colours that will brighten up balconies and rooftop railings even more. New addition to the range: balcony troughs in two commercial sizes plus a drainpipe clicker to utilise unused outdoor spaces to surround yourself with green.



NICE THINGS TO KNOW ABOUT THE FAMILY



FITS EVERY BALCONY



OVERFLOW PIPE



MORE SOIL CAPACITY



MADE OUT OF RECYCLED PLASTICS



LIGHT WEIGHT



LONG-LASTING COLOUR



FROST PROOF



trough



trough all-in-1



drainpipe clicker



flower twin



flower bridge



easy hanger S



easy hanger M



easy hanger L



vertical forest



wall basket

INNOVATIONS

vibia campana trough
vibia campana trough all-in-1
vibia campana drainpipe clicker

NEW COLOUR

terra

colours

125

260

270

359

new

425

451

542





vibia campana balcony COLLECTION

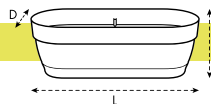

VIBIA CAMPANA TROUGH

size = L x D, height = H

NEW

| description | | | | | | | additional information |
|---------------------------|-------------|------|------|------|---|-----|------------------------|
| vibia campana trough 50cm | 49.0 x 18.2 | 17.0 | 11.0 | 0.56 | 5 | 560 | |

| | art. number | | ean code | | art. number | | ean code | | art. number | | ean code |
|--|-------------------|---|----------|--|-------------------|---|----------|--|-------------------|---|----------|
| | 37 417 050 125 00 | 5 | | | 37 417 050 359 00 | 5 | | | 37 417 050 451 00 | 5 | |
| | 37 417 050 260 00 | 5 | | | 37 417 050 425 00 | 5 | | | 37 417 050 542 00 | 5 | |
| | 37 417 050 270 00 | 5 | | | | | | | | | |

| description | | | | | | | additional information |
|---------------------------|-------------|------|------|------|---|-----|------------------------|
| vibia campana trough 70cm | 69.0 x 18.2 | 17.0 | 15.5 | 0.79 | 5 | 420 | |

| | art. number | | ean code | | art. number | | ean code | | art. number | | ean code |
|--|-------------------|---|----------|--|-------------------|---|----------|--|-------------------|---|----------|
| | 37 417 070 125 00 | 5 | | | 37 417 070 359 00 | 5 | | | 37 417 070 451 00 | 5 | |
| | 37 417 070 260 00 | 5 | | | 37 417 070 425 00 | 5 | | | 37 417 070 542 00 | 5 | |
| | 37 417 070 270 00 | 5 | | | | | | | | | |

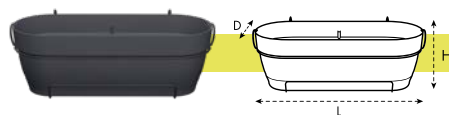

VIBIA CAMPANA TROUGH ALL-IN-1

size = L x D, height = H

NEW

| description | | | | | | | additional information |
|------------------------------------|-------------|------|------|------|---|-----|------------------------|
| vibia campana trough all-in-1 50cm | 50.4 x 26.0 | 17.7 | 11.0 | 1.13 | 5 | 120 | |

| | art. number | | ean code | | art. number | | ean code | | art. number | | ean code |
|-----|-------------------|---|----------|-----|-------------------|---|----------|-----|-------------------|---|----------|
| 125 | 37 418 050 125 00 | 5 | | 359 | 37 418 050 359 00 | 5 | | 451 | 37 418 050 451 00 | 5 | |
| 260 | 37 418 050 260 00 | 5 | | 425 | 37 418 050 425 00 | 5 | | 542 | 37 418 050 542 00 | 5 | |
| 270 | 37 418 050 270 00 | 5 | | | | | | | | | |

| description | | | | | | | additional information |
|------------------------------------|-------------|------|------|------|---|----|------------------------|
| vibia campana trough all-in-1 70cm | 70.4 x 26.0 | 17.7 | 11.0 | 1.49 | 5 | 60 | |

| | art. number | | ean code | | art. number | | ean code | | art. number | | ean code |
|-----|-------------------|---|----------|-----|-------------------|---|----------|-----|-------------------|---|----------|
| 125 | 37 418 070 125 00 | 5 | | 359 | 37 418 070 359 00 | 5 | | 451 | 37 418 070 451 00 | 5 | |
| 260 | 37 418 070 260 00 | 5 | | 425 | 37 418 070 425 00 | 5 | | 542 | 37 418 070 542 00 | 5 | |
| 270 | 37 418 070 270 00 | 5 | | | | | | | | | |

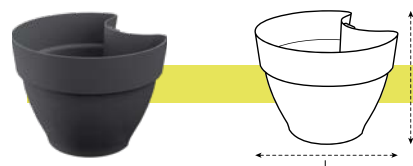

VIBIA CAMPANA DRAINPIPE CLICKER

size = L x D, height = H

NEW

| description | | | | | | | additional information |
|--------------------------------------|------|------|-----|------|----|-----|------------------------|
| vibia campana drainpipe clicker 22cm | 21.6 | 16.3 | 3.1 | 0.19 | 10 | 630 | |

| | art. number | | ean code | | art. number | | ean code | | art. number | | ean code |
|-----|-------------------|----|----------|-----|-------------------|----|----------|-----|-------------------|----|----------|
| 125 | 37 316 022 125 00 | 10 | | 359 | 37 316 022 359 00 | 10 | | 451 | 37 316 022 451 00 | 10 | |
| 260 | 37 316 022 260 00 | 10 | | 425 | 37 316 022 425 00 | 10 | | 542 | 37 316 022 542 00 | 10 | |
| 270 | 37 316 022 270 00 | 10 | | | | | | | | | |

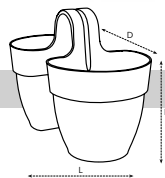

VIBIA CAMPANA FLOWER TWIN

size = L x D, height = H



| description | | | | | | | additional information |
|--------------------------------|-------------|------|-----|------|---|-----|------------------------|
| vibia campana flower twin 21cm | 20.5 x 38.4 | 26.5 | 5.6 | 0.41 | 8 | 160 | |

| | art. number | | ean code | | art. number | | ean code | | art. number | | ean code |
|--|-------------------|---|----------|--|-------------------|---|----------|--|-------------------|---|----------|
| | 36 526 021 125 00 | 8 | | | 36 526 021 359 00 | 8 | | | 36 526 021 451 00 | 8 | |
| | 36 526 021 260 00 | 8 | | | 36 526 021 425 00 | 8 | | | 36 526 021 542 00 | 8 | |
| | 36 526 021 270 00 | 8 | | | | | | | | | |

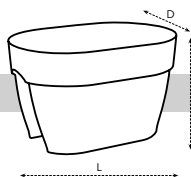

VIBIA CAMPANA FLOWER BRIDGE

size = L x D, height = H



| description | | | | | | | additional information |
|----------------------------------|-------------|------|------|------|---|-----|------------------------|
| vibia campana flower bridge 40cm | 39.0 x 26.0 | 22.0 | 10.0 | 0.73 | 8 | 256 | |

| | art. number | | ean code | | art. number | | ean code | | art. number | | ean code |
|--|-------------------|---|----------|--|-------------------|---|----------|--|-------------------|---|----------|
| | 36 822 040 125 00 | 8 | | | 36 822 040 359 00 | 8 | | | 36 822 040 451 00 | 8 | |
| | 36 822 040 260 00 | 8 | | | 36 822 040 425 00 | 8 | | | 36 822 040 542 00 | 8 | |
| | 36 822 040 270 00 | 8 | | | | | | | | | |

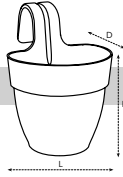

VIBIA CAMPANA EASY HANGER S

size = L x D, height = H



| description | ∅ | ↓ | Ltr | Kg | 📦 | 📦 | additional information |
|---------------------------------|------|------|-----|------|----|-----|------------------------|
| vibia campana easy hanger small | 20.5 | 26.5 | 2.8 | 0.23 | 10 | 280 | |

| 📦 | art. number | 📦 | ean code | 📦 | art. number | 📦 | ean code | 📦 | art. number | 📦 | ean code |
|-----|-------------------|----|----------|-----|-------------------|----|----------|-----|-------------------|----|----------|
| 125 | 36 426 021 125 00 | 10 | | 359 | 36 426 021 359 00 | 10 | | 451 | 36 426 021 451 00 | 10 | |
| 260 | 36 426 021 260 00 | 10 | | 425 | 36 426 021 425 00 | 10 | | 542 | 36 426 021 542 00 | 10 | |
| 270 | 36 426 021 270 00 | 10 | | | | | | | | | |

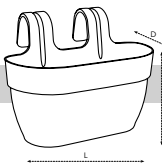

VIBIA CAMPANA EASY HANGER M

size = L x D, height = H



| description | ↔ | ↓ | Ltr | Kg | 📦 | 📦 | additional information |
|----------------------------------|-------------|------|-----|------|----|-----|------------------------|
| vibia campana easy hanger medium | 36.0 x 24.1 | 26.5 | 5.8 | 0.40 | 10 | 240 | |

| 📦 | art. number | 📦 | ean code | 📦 | art. number | 📦 | ean code | 📦 | art. number | 📦 | ean code |
|-----|-------------------|----|----------|-----|-------------------|----|----------|-----|-------------------|----|----------|
| 125 | 36 626 036 125 00 | 10 | | 359 | 36 626 036 359 00 | 10 | | 451 | 36 626 036 451 00 | 10 | |
| 260 | 36 626 036 260 00 | 10 | | 425 | 36 626 036 425 00 | 10 | | 542 | 36 626 036 542 00 | 10 | |
| 270 | 36 626 036 270 00 | 10 | | | | | | | | | |



VIBIA CAMPANA EASY HANGER L

size = L x D, height = H

NEW COLOUR



| description | | | | | | | additional information |
|---------------------------------|-------------|------|-----|------|---|-----|------------------------|
| vibia campana easy hanger large | 46.0 x 24.1 | 26.5 | 7.5 | 0.48 | 8 | 128 | |

| | art. number | | ean code | | art. number | | ean code | | art. number | | ean code |
|-----|-------------------|---|----------|-----|-------------------|---|----------|-----|-------------------|---|----------|
| 125 | 36 726 046 125 00 | 8 | | 359 | 36 726 046 359 00 | 8 | | 451 | 36 726 046 451 00 | 8 | |
| 260 | 36 726 046 260 00 | 8 | | 425 | 36 726 046 425 00 | 8 | | 542 | 36 726 046 542 00 | 8 | |
| 270 | 36 726 046 270 00 | 8 | | | | | | | | | |

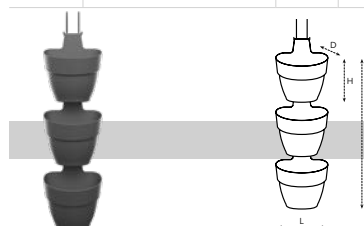

VIBIA CAMPANA VERTICAL FOREST

size = L x D, height = H

NEW COLOUR



| description | | | | | | | additional information |
|-------------------------------------|------|------|-----|------|---|-----|------------------------------------------------------------------------------------|
| vibia campana vertical forest set/3 | 20.7 | 29.7 | 8.0 | 0.66 | 8 | 192 | measurements for complete set incl. hooks. Both balcony and wall hooks included |

| | art. number | | ean code | | art. number | | ean code | | art. number | | ean code |
|-----|-------------------|---|----------|-----|-------------------|---|----------|-----|-------------------|---|----------|
| 125 | 36 924 021 125 00 | 8 | | 359 | 36 924 021 359 00 | 8 | | 451 | 36 924 021 451 00 | 8 | |
| 260 | 36 924 021 260 00 | 8 | | 425 | 36 924 021 425 00 | 8 | | 542 | 36 924 021 542 00 | 8 | |
| 270 | 36 924 021 270 00 | 8 | | | | | | | | | |

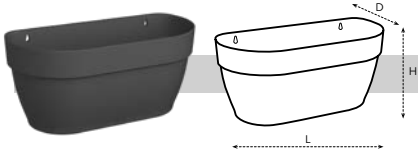

VIBIA CAMPANA WALL BASKET

size = L x D, height = H

NEW COLOUR



| description | | | | | | | additional information |
|--------------------------------|-------------|------|-----|------|----|-----|------------------------|
| vibia campana wall basket 35cm | 35.0 x 16.2 | 14.8 | 5.4 | 0.29 | 10 | 420 | |

| | art. number | | ean code | | art. number | | ean code | | art. number | | ean code |
|--|-------------------|----|----------|--|-------------------|----|----------|--|-------------------|----|----------|
| | 37 015 035 125 00 | 10 | | | 37 015 035 359 00 | 10 | | | 37 015 035 451 00 | 10 | |
| | 37 015 035 260 00 | 10 | | | 37 015 035 425 00 | 10 | | | 37 015 035 542 00 | 10 | |
| | 37 015 035 270 00 | 10 | | | | | | | | | |



VIBIA CAMPANA TERRACE

This family has a classic but contemporary look with its slightly rounded body, still subtle and perfectly suited to voluptuous and outgoing plants. Made with a rough, high-quality texture, available in soothing, natural tones that fit perfectly with the natural vibe of nowadays gardens.

NICE THINGS TO KNOW ABOUT THE FAMILY

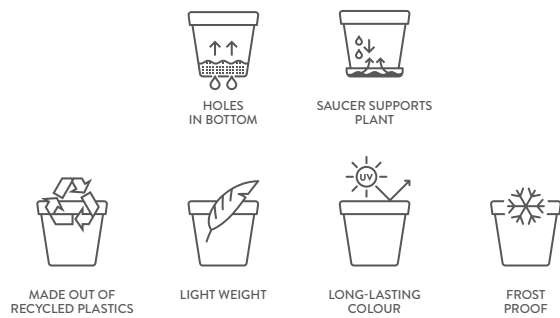

colours

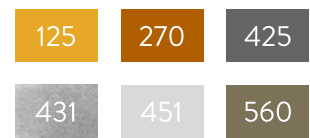

vibia campana terrace COLLECTION

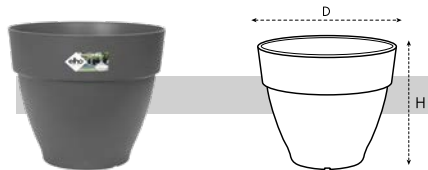

VIBIA CAMPANA ROUND

size = L x D, height = H
for matching saucers, see p. 326-327

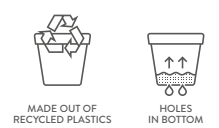

| description | | | | | | | additional information |
|--------------------------|------|------|-----|------|----|------|------------------------|
| vibia campana round 20cm | 19.5 | 16.8 | 3.2 | 0.16 | 10 | 1680 | Ø14 |

| | art. number | | ean code | | art. number | | ean code | | art. number | | ean code |
|--|-------------|-------------------|----------|--|-----------------|--|----------|-------------------|-------------|--|-----------------|
| | 125 | 07 167 195 125 00 | 10 | | 8 711904 500085 | | 425 | 07 167 195 425 00 | 10 | | 8 711904 333171 |
| | 270 | 07 167 195 270 00 | 10 | | 8 711904 482657 | | 431 | 07 167 195 431 00 | 10 | | 8 711904 333294 |
| | 560 | 07 167 195 560 00 | 10 | | 8 711904 482695 | | | | | | |

| description | | | | | | | additional information |
|--------------------------|------|------|-----|------|----|-----|------------------------|
| vibia campana round 25cm | 24.5 | 21.0 | 6.5 | 0.30 | 10 | 700 | Ø17 |

| | art. number | | ean code | | art. number | | ean code | | art. number | | ean code |
|--|-------------|-------------------|----------|--|-----------------|--|----------|-------------------|-------------|--|-----------------|
| | 125 | 07 210 245 125 00 | 10 | | 8 711904 500054 | | 425 | 07 210 245 425 00 | 10 | | 8 711904 333188 |
| | 270 | 07 210 245 270 00 | 10 | | 8 711904 482732 | | 431 | 07 210 245 431 00 | 10 | | 8 711904 333300 |
| | 560 | 07 210 245 560 00 | 10 | | 8 711904 482770 | | | | | | |

| description | | | | | | | additional information |
|--------------------------|------|------|------|------|----|-----|------------------------|
| vibia campana round 30cm | 29.8 | 25.8 | 11.3 | 0.51 | 10 | 400 | Ø21 |

| | art. number | | ean code | | art. number | | ean code | | art. number | | ean code |
|--|-------------|-------------------|----------|--|-----------------|--|----------|-------------------|-------------|--|-----------------|
| | 125 | 07 248 290 125 00 | 10 | | 8 711904 499990 | | 425 | 07 248 290 425 00 | 10 | | 8 711904 333195 |
| | 270 | 07 248 290 270 00 | 10 | | 8 711904 482817 | | 431 | 07 248 290 431 00 | 10 | | 8 711904 333317 |
| | 560 | 07 248 290 560 00 | 10 | | 8 711904 482855 | | | | | | |

| description | | | | | | | additional information |
|--------------------------|------|------|------|------|----|-----|------------------------|
| vibia campana round 35cm | 34.5 | 29.7 | 41.2 | 0.71 | 10 | 240 | Ø24 |

| | art. number | | ean code | | art. number | | ean code | | art. number | | ean code |
|--|-------------------|----|----------|--|-------------------|----|----------|--|-------------------|----|----------|
| | 07 291 339 125 00 | 10 | | | 07 291 339 425 00 | 10 | | | 07 291 339 451 00 | 10 | |
| | 07 291 339 270 00 | 10 | | | 07 291 339 431 00 | 10 | | | 07 291 339 560 00 | 10 | |

| description | | | | | | | additional information |
|--------------------------|------|------|------|------|---|-----|------------------------|
| vibia campana round 40cm | 39.0 | 33.4 | 26.2 | 1.05 | 5 | 210 | Ø28 |

| | art. number | | ean code | | art. number | | ean code | | art. number | | ean code |
|--|-------------------|---|----------|--|-------------------|---|----------|--|-------------------|---|----------|
| | 07 334 390 125 00 | 5 | | | 07 334 390 425 00 | 5 | | | 07 334 390 451 00 | 5 | |
| | 07 334 390 270 00 | 5 | | | 07 334 390 431 00 | 5 | | | 07 334 390 560 00 | 5 | |

| description | | | | | | | additional information |
|--------------------------|------|------|------|------|---|----|------------------------|
| vibia campana round 47cm | 47.0 | 40.4 | 46.0 | 1.61 | 5 | 90 | Ø34 |

| | art. number | | ean code | | art. number | | ean code | | art. number | | ean code |
|--|-------------------|---|----------|--|-------------------|---|----------|--|-------------------|---|----------|
| | 07 402 470 270 00 | 5 | | | 07 402 470 431 00 | 5 | | | 07 402 470 560 00 | 5 | |
| | 07 402 470 425 00 | 5 | | | 07 402 470 451 00 | 5 | | | | | |

| description | | | | | | | additional information |
|--------------------------|------|------|------|------|---|----|------------------------|
| vibia campana round 55cm | 54.5 | 47.0 | 74.0 | 2.23 | 4 | 48 | Ø41 |

| | art. number | | ean code | | art. number | | ean code | | art. number | | ean code |
|--|-------------------|---|----------|--|-------------------|---|----------|--|-------------------|---|----------|
| | 07 847 155 270 00 | 4 | | | 07 847 155 431 00 | 4 | | | 07 847 155 560 00 | 4 | |
| | 07 847 155 425 00 | 4 | | | 07 847 155 451 00 | 4 | | | | | |



VIBIA CAMPANA BOWL

size = L x D, height = H
for matching saucers, see p. 326-327



| description | | | | | | | additional information |
|-------------------------|------|------|-----|------|---|-----|------------------------|
| vibia campana bowl 27cm | 27.0 | 14.0 | 5.7 | 0.30 | 5 | 440 | Ø24 |

| | art. number | | ean code | | art. number | | ean code | | art. number | | ean code |
|-----|-------------------|---|----------|-----|-------------------|---|----------|-----|-------------------|---|----------|
| 125 | 07 613 927 125 00 | 5 | | 425 | 07 613 927 425 00 | 5 | | 451 | 07 613 927 451 00 | 5 | |
| 270 | 07 613 927 270 00 | 5 | | 431 | 07 613 927 431 00 | 5 | | 560 | 07 613 927 560 00 | 5 | |

| description | | | | | | | additional information |
|-------------------------|------|------|------|------|----|-----|------------------------|
| vibia campana bowl 34cm | 33.9 | 17.4 | 11.0 | 0.54 | 10 | 360 | Ø30 |

| | art. number | | ean code | | art. number | | ean code | | art. number | | ean code |
|-----|-------------------|----|----------|-----|-------------------|----|----------|-----|-------------------|----|----------|
| 125 | 37 117 034 125 00 | 10 | | 425 | 37 117 034 425 00 | 10 | | 451 | 37 117 034 451 00 | 10 | |
| 270 | 37 117 034 270 00 | 10 | | 431 | 37 117 034 431 00 | 10 | | 560 | 37 117 034 560 00 | 10 | |

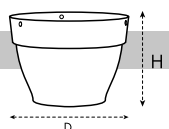

VIBIA CAMPANA HANGING BASKET

size = L x D, height = H



| description | | | | | | | additional information |
|-----------------------------------|------|------|-----|------|----|-----|------------------------|
| vibia campana hanging basket 26cm | 26.0 | 18.4 | 6.5 | 0.31 | 10 | 200 | |

| | art. number | | ean code | | art. number | | ean code | | art. number | | ean code |
|-----|-------------------|----|----------|-----|-------------------|----|----------|-----|-------------------|----|----------|
| 125 | 15 318 026 125 00 | 10 | | 425 | 15 318 026 425 00 | 10 | | 451 | 15 318 026 451 00 | 10 | |
| 270 | 15 318 026 270 00 | 10 | | 431 | 15 318 026 431 00 | 10 | | 560 | 15 318 026 560 00 | 10 | |
| 359 | 15 318 026 359 00 | 10 | | | | | | | | | |

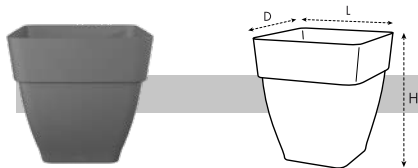

VIBIA CAMPANA SQUARE

size = L x D, height = H
for matching saucers, see p. 326-327



| description | | | | | | | additional information |
|---------------------------|-------------|------|------|------|---|-----|------------------------|
| vibia campana square 30cm | 28.8 x 28.8 | 28.2 | 15.1 | 0.63 | 5 | 320 | 22 |

| | art. number | | ean code | | art. number | | ean code | | art. number | | ean code |
|-----|-------------------|---|----------|-----|-------------------|---|----------|-----|-------------------|---|----------|
| 270 | 15 428 029 270 00 | 5 | | 431 | 15 428 029 431 00 | 5 | | 560 | 15 428 029 560 00 | 5 | |
| 425 | 15 428 029 425 00 | 5 | | 451 | 15 428 029 451 00 | 5 | | | | | |

| description | | | | | | | additional information |
|---------------------------|-------------|------|------|------|---|-----|------------------------|
| vibia campana square 37cm | 36.4 x 36.4 | 35.6 | 30.0 | 1.12 | 5 | 180 | 28 |

| | art. number | | ean code | | art. number | | ean code | | art. number | | ean code |
|-----|-------------------|---|----------|-----|-------------------|---|----------|-----|-------------------|---|----------|
| 270 | 15 735 036 270 00 | 5 | | 431 | 15 735 036 431 00 | 5 | | 560 | 15 735 036 560 00 | 5 | |
| 425 | 15 735 036 425 00 | 5 | | 451 | 15 735 036 451 00 | 5 | | | | | |



VIBIA CAMPANA TERRACE TROUGH

size = L x D, height = H



| description | | | | | | | additional information |
|-----------------------------------|-------------|------|------|------|---|----|------------------------|
| vibia campana terrace trough 80cm | 76.5 x 35.0 | 33.3 | 63.0 | 1.94 | 3 | 63 | |







| | art. number | | ean code | | art. number | | ean code | | art. number | | ean code |
|-----|-------------------|---|----------|-----|-------------------|---|----------|-----|-------------------|---|----------|
| 270 | 07 733 277 270 00 | 3 | | 431 | 07 733 277 431 00 | 3 | | 560 | 07 733 277 560 00 | 3 | |
| 425 | 07 733 277 425 00 | 3 | | 451 | 07 733 277 451 00 | 3 | | | | | |



VIBIA STRAIGHT

The vibia straight is a proven design for every modern terrace. This outdoor pot is made with a rough, high-quality texture and comes in various natural tones that match the green vibes of your favourite garden plants.

NICE THINGS TO KNOW ABOUT THE FAMILY

-  HOLES IN BOTTOM
-  SAUCER SUPPORTS PLANT
-  MADE OUT OF RECYCLED PLASTICS
-  LIGHT WEIGHT
-  LONG-LASTING COLOUR
-  FROST PROOF



round



AVAILABLE SIZES

25, 30, 40 & 47cm

colours

150

425

431

vibia straight COLLECTION

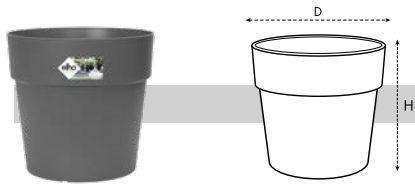

VIBIA STRAIGHT ROUND

size = L x D, height = H
for matching saucers, see p. 326-327

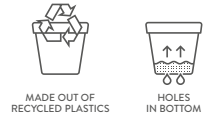

| description | | | | | | | additional information |
|---------------------------|------|------|-----|------|----|-----|------------------------|
| vibia straight round 25cm | 24.3 | 23.2 | 8.0 | 0.35 | 10 | 560 | Ø21 |

| | art. number | | ean code | | art. number | | ean code | | art. number | | ean code |
|-----|-------------------|----|-----------------|-----|-------------------|----|-----------------|-----|-------------------|----|-----------------|
| 150 | 04 423 024 150 00 | 10 | 8 711904 332198 | 425 | 04 423 024 425 00 | 10 | 8 711904 332297 | 431 | 04 423 024 431 00 | 10 | 8 711904 332495 |

| description | | | | | | | additional information |
|---------------------------|------|------|------|------|----|-----|------------------------|
| vibia straight round 30cm | 29.3 | 28.0 | 13.9 | 0.60 | 10 | 240 | Ø28 |

| | art. number | | ean code | | art. number | | ean code | | art. number | | ean code |
|-----|-------------------|----|-----------------|-----|-------------------|----|-----------------|-----|-------------------|----|-----------------|
| 150 | 04 427 729 150 00 | 10 | 8 711904 332204 | 425 | 04 427 729 425 00 | 10 | 8 711904 332303 | 431 | 04 427 729 431 00 | 10 | 8 711904 332501 |

| description | | | | | | | additional information |
|---------------------------|------|------|------|------|---|-----|------------------------|
| vibia straight round 40cm | 39.0 | 36.8 | 32.2 | 1.29 | 5 | 150 | Ø34 |

| | art. number | | ean code | | art. number | | ean code | | art. number | | ean code |
|-----|-------------------|---|-----------------|-----|-------------------|---|-----------------|-----|-------------------|---|-----------------|
| 150 | 04 436 639 150 00 | 5 | 8 711904 332211 | 425 | 04 436 639 425 00 | 5 | 8 711904 332310 | 431 | 04 436 639 431 00 | 5 | 8 711904 332518 |

| description | | | | | | | additional information |
|---------------------------|------|------|------|------|---|----|------------------------|
| vibia straight round 47cm | 47.0 | 44.4 | 56.7 | 1.86 | 5 | 60 | Ø41 |

| | art. number | | ean code | | art. number | | ean code | | art. number | | ean code |
|-----|-------------------|---|-----------------|-----|-------------------|---|-----------------|-----|-------------------|---|-----------------|
| 150 | 04 444 247 150 00 | 5 | 8 711904 332226 | 425 | 04 444 247 425 00 | 5 | 8 711904 332327 | 431 | 04 444 247 431 00 | 5 | 8 711904 332525 |

vibia INSTORE PRESENTATIONS



VIBIA CAMPANA TROUGH ALL-IN-1 50cm DISPLAY

NEW



- inspire your shopper, present this unique new product on a high-traffic location in your store

| art. number | size lxd | | m ² | product | | qty. | | qty. | | qty. | ean code |
|-------------------|----------|-----|----------------|------------------------------------|-----|------|-----|------|-----|------|-----------------|
| 37 400 001 901 10 | 60 x 80 | 100 | 0.48 | vibia campana trough all-in-1 50cm | 359 | 11 | 425 | 11 | 542 | 11 | 8 711904 523985 |

| art. number | size lxd | | m ² | product | | qty. | | qty. | | qty. | ean code |
|-------------------|----------|-----|----------------|------------------------------------|-----|------|-----|------|-----|------|-----------------|
| 37 400 001 902 10 | 60 x 80 | 100 | 0.48 | vibia campana trough all-in-1 50cm | 270 | 11 | 425 | 11 | 451 | 11 | 8 711904 523978 |

| art. number | size lxd | | m ² | product | | qty. | | qty. | | qty. | ean code |
|-------------------|----------|-----|----------------|------------------------------------|-----|------|-----|------|-----|------|-----------------|
| 37 400 001 903 10 | 60 x 80 | 100 | 0.48 | vibia campana trough all-in-1 50cm | 125 | 11 | 270 | 11 | 451 | 11 | 8 711904 523961 |



VIBIA CAMPANA TROUGH ALL-IN-1 70cm DISPLAY

NEW



- inspire your shopper, present this unique new product on a high-traffic location in your store

| art. number | size lxd | | m ² | product | | qty. | | qty. | ean code |
|-------------------|----------|-----|----------------|------------------------------------|-----|------|-----|------|-----------------|
| 37 400 002 901 10 | 60 x 80 | 100 | 0.48 | vibia campana trough all-in-1 70cm | 425 | 11 | 451 | 11 | 8 711904 524005 |

| art. number | size lxd | | m ² | product | | qty. | | qty. | ean code |
|-------------------|----------|-----|----------------|------------------------------------|-----|------|-----|------|-----------------|
| 37 400 002 902 10 | 60 x 80 | 100 | 0.48 | vibia campana trough all-in-1 70cm | 270 | 11 | 425 | 11 | 8 711904 523992 |



VIBIA DRAINPIPE CLICKER SHELF-DEMO UNIVERSAL

NEW



- ideal presentation for concept explanation and attracting the shopper

| art. number | description | size lxd | h | m ² | | ean code |
|-------------------|----------------------------------------|-----------|-----|----------------|---|-----------------|
| 75 000 001 901 50 | drainpipe clicker shelf-demo universal | 24 x 19.5 | 118 | 0.28 | 1 | 8 711904 523718 |



VIBIA CAMPANA VERTICAL FOREST DISPLAY



• let's seduce your shopper, stimulate the buying impulse with this innovative concept

| art. number | size lxd | | m ² | product | | qty. | | qty. | | qty. | ean code |
|-------------------|----------|-----|----------------|-------------------------------------|-----|------|-----|------|-----|------|-----------------|
| 36 900 001 901 10 | 60 x 80 | 100 | 0.48 | vibia campana vertical forest set/3 | 359 | 24 | 425 | 24 | 542 | 24 | 8 711904 508869 |

| art. number | size lxd | | m ² | product | | qty. | | qty. | | qty. | ean code |
|-------------------|----------|-----|----------------|-------------------------------------|-----|------|-----|------|-----|------|-----------------|
| 36 900 001 902 10 | 60 x 80 | 100 | 0.48 | vibia campana vertical forest set/3 | 425 | 24 | 451 | 24 | 542 | 24 | 8 711904 508876 |

| art. number | size lxd | | m ² | product | | qty. | | qty. | | qty. | ean code |
|-------------------|----------|-----|----------------|-------------------------------------|-----|------|-----|------|-----|------|-----------------|
| 36 900 001 903 10 | 60 x 80 | 100 | 0.48 | vibia campana vertical forest set/3 | 125 | 24 | 260 | 24 | 451 | 24 | 8 711904 508883 |

| art. number | size lxd | | m ² | product | | qty. | | qty. | | qty. | ean code |
|-------------------|----------|-----|----------------|-------------------------------------|-----|------|-----|------|-----|------|-----------------|
| 36 900 001 905 10 | 60 x 80 | 100 | 0.48 | vibia campana vertical forest set/3 | 270 | 24 | 425 | 24 | 451 | 24 | 8 711904 523916 |



VIBIA CAMPANA FLOWER TWIN DISPLAY



• inspire your shopper, present this unique balcony product on a high-traffic location in your store

| art. number | size lxd | | m ² | product | | qty. | | qty. | | qty. | ean code | | |
|-------------------|----------|-----|----------------|--------------------------------|-----|------|-----|------|-----|------|----------|----|-----------------|
| 36 500 001 901 10 | 60 x 80 | 100 | 0.48 | vibia campana flower twin 21cm | 359 | 14 | 425 | 14 | 451 | 14 | 542 | 14 | 8 711904 508920 |

| art. number | size lxd | | m ² | product | | qty. | | qty. | | qty. | ean code | | |
|-------------------|----------|-----|----------------|--------------------------------|-----|------|-----|------|-----|------|----------|----|-----------------|
| 36 500 001 902 10 | 60 x 80 | 100 | 0.48 | vibia campana flower twin 21cm | 125 | 14 | 425 | 14 | 451 | 14 | 542 | 14 | 8 711904 508937 |

| art. number | size lxd | | m ² | product | | qty. | | qty. | | qty. | ean code | | |
|-------------------|----------|-----|----------------|--------------------------------|-----|------|-----|------|-----|------|----------|----|-----------------|
| 36 500 001 904 10 | 60 x 80 | 100 | 0.48 | vibia campana flower twin 21cm | 125 | 14 | 270 | 14 | 425 | 14 | 451 | 14 | 8 711904 523923 |



VIBIA CAMPANA FLOWER BRIDGE DISPLAY

NEW COLOUR



- create awareness, ideal second placement for vibia balcony products

| art. number | size lxd | | m ² | product | | qty. | | qty. | | qty. | | qty. | ean code |
|-------------------|----------|-----|----------------|----------------------------------|-----|------|-----|------|-----|------|-----|------|-----------------|
| 36 800 040 902 10 | 60 x 80 | 100 | 0.48 | vibia campana flower bridge 40cm | 125 | 15 | 425 | 15 | 451 | 15 | 542 | 15 | 8 711904 508753 |

| art. number | size lxd | | m ² | product | | qty. | | qty. | | qty. | | qty. | ean code |
|-------------------|----------|-----|----------------|----------------------------------|-----|------|-----|------|-----|------|-----|------|-----------------|
| 36 800 040 903 10 | 60 x 80 | 100 | 0.48 | vibia campana flower bridge 40cm | 359 | 15 | 425 | 15 | 451 | 15 | 542 | 15 | 8 711904 508791 |

| art. number | size lxd | | m ² | product | | qty. | | qty. | | qty. | | qty. | ean code |
|-------------------|----------|-----|----------------|----------------------------------|-----|------|-----|------|-----|------|-----|------|-----------------|
| 36 800 040 904 10 | 60 x 80 | 100 | 0.48 | vibia campana flower bridge 40cm | 125 | 15 | 270 | 15 | 425 | 15 | 451 | 15 | 8 711904 523930 |



VIBIA CAMPANA EASY HANGER SMALL & MEDIUM DISPLAY

NEW COLOUR



- boost your sales: display with vibia balcony products to inspire your shopper

| art. number | size lxd | | m ² | product | | qty. | | qty. | | qty. | | qty. | ean code |
|-------------------|----------|-----|----------------|----------------------------------|-----|------|-----|------|-----|------|-----------------|------|----------|
| 36 400 001 901 10 | 60 x 80 | 100 | 0.48 | vibia campana easy hanger small | 359 | 14 | 425 | 14 | 542 | 14 | 8 711904 508807 | | |
| | | | | vibia campana easy hanger medium | 359 | 14 | 425 | 14 | 542 | 14 | | | |

| art. number | size lxd | | m ² | product | | qty. | | qty. | | qty. | | qty. | ean code |
|-------------------|----------|-----|----------------|----------------------------------|-----|------|-----|------|-----|------|-----------------|------|----------|
| 36 400 001 902 10 | 60 x 80 | 100 | 0.48 | vibia campana easy hanger small | 425 | 14 | 451 | 14 | 542 | 14 | 8 711904 508814 | | |
| | | | | vibia campana easy hanger medium | 425 | 14 | 451 | 14 | 542 | 14 | | | |

| art. number | size lxd | | m ² | product | | qty. | | qty. | | qty. | | qty. | ean code |
|-------------------|----------|-----|----------------|----------------------------------|-----|------|-----|------|-----|------|-----------------|------|----------|
| 36 400 001 903 10 | 60 x 80 | 100 | 0.48 | vibia campana easy hanger small | 125 | 14 | 260 | 14 | 451 | 14 | 8 711904 508821 | | |
| | | | | vibia campana easy hanger medium | 125 | 14 | 260 | 14 | 451 | 14 | | | |



| art. number | size lxd | | m ² | product | | qty. | | qty. | | qty. | ean code |
|-------------------|----------|-----|----------------|----------------------------------|-----|------|-----|------|-----|------|------------------|
| 36 400 001 905 10 | 60 x 80 | 100 | 0.48 | vibia campana easy hanger small | 270 | 14 | 425 | 14 | 451 | 14 | 8 711904 1523947 |
| | | | | vibia campana easy hanger medium | 270 | 14 | 425 | 14 | 451 | 14 | |



VIBIA CAMPANA EASY HANGER LARGE DISPLAY

- boost your sales: display with vibia balcony products to inspire your shopper



| art. number | size lxd | | m ² | product | | qty. | | qty. | | qty. | ean code |
|-------------------|----------|-----|----------------|---------------------------------|-----|------|-----|------|-----|------|-----------------|
| 36 700 006 901 10 | 60 x 80 | 100 | 0.48 | vibia campana easy hanger large | 359 | 18 | 425 | 19 | 542 | 19 | 8 711904 508845 |

| art. number | size lxd | | m ² | product | | qty. | | qty. | | qty. | ean code |
|-------------------|----------|-----|----------------|---------------------------------|-----|------|-----|------|-----|------|-----------------|
| 36 700 006 902 10 | 60 x 80 | 100 | 0.48 | vibia campana easy hanger large | 425 | 19 | 451 | 18 | 542 | 19 | 8 711904 508852 |

| art. number | size lxd | | m ² | product | | qty. | | qty. | | qty. | ean code |
|-------------------|----------|-----|----------------|---------------------------------|-----|------|-----|------|-----|------|-----------------|
| 36 700 006 903 10 | 60 x 80 | 100 | 0.48 | vibia campana easy hanger large | 125 | 19 | 260 | 18 | 451 | 19 | 8 711904 508906 |

| art. number | size lxd | | m ² | product | | qty. | | qty. | | qty. | ean code |
|-------------------|----------|-----|----------------|---------------------------------|-----|------|-----|------|-----|------|------------------|
| 36 700 006 905 10 | 60 x 80 | 100 | 0.48 | vibia campana easy hanger large | 270 | 18 | 425 | 19 | 451 | 19 | 8 711904 1523954 |



INSPIRATIONAL BALCONY HEADER

- inspire your shopper, ideal presentation to attract shopper's attention and demonstrate pot-plant combinations



DEMONSTRATION STAND

| art. number | description | size lxd | h | m ² | | ean code |
|-------------------|------------------------------------------|-----------|----|----------------|---|-----------------|
| 19 100 033 724 50 | inspirational balcony header metal 200cm | 187 x 102 | 79 | 1.9 | 1 | 8 711904 509347 |



BALCONY SHELF PRESENTATION

- live presentation of corsica balcony products possible



DEMONSTRATION STAND

| art. number | description | size lxd | h | m ² | | ean code |
|-------------------|----------------------------|----------|-----|----------------|---|-----------------|
| 74 000 017 425 30 | balcony shelf presentation | 200 x 71 | 190 | 1.42 | 1 | 8 711904 217242 |



PLANT TABLE BALCONY PRESENTATION

- inspire your shopper with pot-plant combinations on stand



DEMONSTRATION STAND

| art. number | description | size lxd | h | m ² | | ean code |
|-------------------|----------------------------------|----------|----|----------------|---|-----------------|
| 19 100 012 150 50 | plant table balcony presentation | 100 x 47 | 62 | 0.42 | 1 | 8 711904 266974 |



VIBIA CAMPANA 30CM DISPLAY

- ideal presentation to boost your seasonal sales



| art. number | size lxd | | m ² | product | | qty. | | qty. | | qty. | | qty. | ean code | | | | |
|-------------------|----------|-----|----------------|--------------------------|--|------|----|------|-----|------|--|------|----------|--|-----|----|-----------------|
| 07 200 001 901 10 | 60 x 80 | 100 | 0.48 | vibia campana round 30cm | | 270 | 17 | | 425 | 17 | | 431 | 17 | | 560 | 17 | 8 711904 485276 |

| art. number | size lxd | | m ² | product | | qty. | | qty. | | qty. | | qty. | ean code | | | | |
|-------------------|----------|-----|----------------|--------------------------|--|------|----|------|-----|------|--|------|----------|--|-----|----|-----------------|
| 15 000 006 901 10 | 60 x 80 | 100 | 0.48 | vibia campana round 30cm | | 270 | 17 | | 425 | 17 | | 431 | 17 | | 451 | 17 | 8 711904 508999 |

| art. number | size lxd | | m ² | product | | qty. | | qty. | | qty. | | qty. | ean code | | | | |
|-------------------|----------|-----|----------------|--------------------------|--|------|----|------|-----|------|--|------|----------|--|-----|----|-----------------|
| 15 000 006 902 10 | 60 x 80 | 100 | 0.48 | vibia campana round 30cm | | 125 | 17 | | 270 | 17 | | 425 | 17 | | 560 | 17 | 8 711904 509002 |



VIBIA CAMPANA ROUND 40 & 47CM ISLAND PRESENTATION

- let's seduce your shopper, stimulate the buying impulse



| art. number | size lxd | m ² | product | | qty. | | qty. | | qty. | | qty. | ean code |
|-------------------|----------|----------------|--------------------------|-----|------|-----|------|-----|------|-----|------|-----------------|
| 07 300 001 901 10 | 120 x 80 | 0.96 | vibia campana round 40cm | 270 | 6 | 425 | 7 | 431 | 7 | 560 | 6 | 8 711904 485290 |
| | | | vibia campana round 47cm | 270 | 5 | 425 | 6 | 431 | 6 | 560 | 5 | |

| art. number | size lxd | m ² | product | | qty. | | qty. | | qty. | | qty. | ean code |
|-------------------|----------|----------------|--------------------------|-----|------|-----|------|-----|------|-----|------|-----------------|
| 15 000 007 901 10 | 120 x 80 | 0.96 | vibia campana round 40cm | 270 | 6 | 425 | 7 | 431 | 7 | 451 | 6 | 8 711904 509019 |
| | | | vibia campana round 47cm | 270 | 5 | 425 | 6 | 431 | 6 | 451 | 5 | |



VIBIA HANGING BASKET SHELF PRESENTATION

- ideal presentation for explanation concept and attracting the shopper



| art. number | description | size lxd | h | m ² | | ean code |
|-------------------|-----------------------------------------|----------|----|----------------|---|-----------------|
| 15 000 028 270 10 | vibia hanging basket shelf presentation | 12 x 16 | 33 | 0.17 | 1 | 8 711904 485887 |



VIBIA STRAIGHT 30CM DISPLAY

- let's seduce your shopper, stimulate the buying impulse







| art. number | size lxd | | m ² | product | | qty. | | qty. | | qty. | ean code |
|-------------------|----------|-----|----------------|---------------------------|-----|------|-----|------|-----|------|-----------------|
| 15 040 004 901 10 | 60 x 80 | 100 | 0.48 | vibia straight round 30cm | 150 | 15 | 425 | 15 | 431 | 14 | 8 711904 508647 |



VIBIA STRAIGHT ROUND 40 & 47CM ISLAND PRESENTATION



- ideal presentation to boost your seasonal sales

| art. number | size lxd | m ² | product |  150 | qty. |  431 | qty. |  425 | qty. | ean code |
|-------------------|----------|----------------|---------------------------|-----------------------------------------------------------------------------------------|------|-----------------------------------------------------------------------------------------|------|-----------------------------------------------------------------------------------------|------|--------------------------------------------------------------------------------------------------------|
| 15 040 004 902 10 | 120 x 80 | 0.96 | vibia straight round 40cm | 150 | 9 | 431 | 9 | 425 | 9 |  8 711904 508654 |
| | | | vibia straight round 47cm | 150 | 4 | 431 | 5 | 425 | 5 | |



GREENVILLE

This family combines a modern, seamless design with a practically clever integrated saucer, so your plants have enough water for a longer time. The products are made of recycled materials and come in natural tones that perfectly fit in a young, urban style.

NICE THINGS TO KNOW ABOUT THE FAMILY



INTEGRATED SAUCER



SAUCER SUPPORTS PLANT



MADE OUT OF RECYCLED PLASTICS



LIGHT WEIGHT



LONG-LASTING COLOUR



FROST PROOF

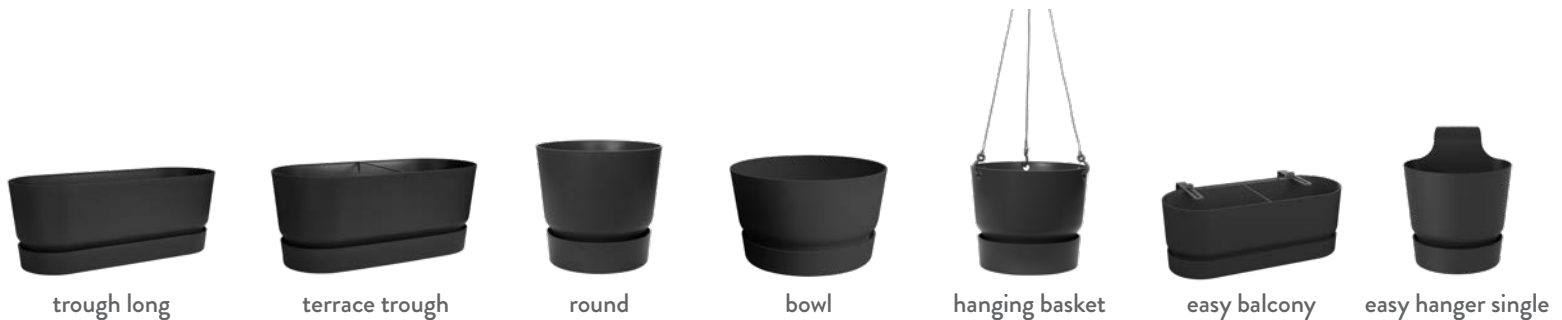

trough long

terrace trough

round

bowl

hanging basket

easy balcony

easy hanger single



colours

150

360

431

433

776



greenville COLLECTION

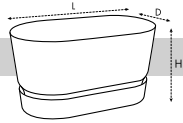

GREENVILLE TROUGH LONG

size = L x D, height = H



INTEGRATED SAUCER



STABILISER



MADE OUT OF RECYCLED PLASTICS



SAUCER SUPPORTS PLANT

| description | | | | | | | additional information |
|-----------------------------|-------------|------|------|------|---|-----|------------------------|
| greenville trough long 50cm | 49.0 x 19.8 | 17.9 | 11.4 | 0.61 | 3 | 108 | |

| | art. number | | ean code | | art. number | | ean code | | art. number | | ean code |
|-----|-------------------|---|----------|-----|-------------------|---|----------|-----|-------------------|---|----------|
| 150 | 14 518 050 150 00 | 3 | | 431 | 14 518 050 431 00 | 3 | | 776 | 14 518 050 776 00 | 3 | |
| 360 | 14 518 050 360 00 | 3 | | 433 | 14 518 050 433 00 | 3 | | | | | |

| description | | | | | | | additional information |
|-----------------------------|-------------|------|------|------|---|----|------------------------|
| greenville trough long 70cm | 69.0 x 18.5 | 17.9 | 16.6 | 0.84 | 3 | 72 | |

| | art. number | | ean code | | art. number | | ean code | | art. number | | ean code |
|-----|-------------------|---|----------|-----|-------------------|---|----------|-----|-------------------|---|----------|
| 150 | 15 118 070 150 00 | 3 | | 431 | 15 118 070 431 00 | 3 | | 776 | 15 118 070 776 00 | 3 | |
| 360 | 15 118 070 360 00 | 3 | | 433 | 15 118 070 433 00 | 3 | | | | | |

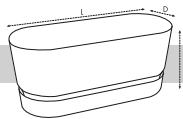

GREENVILLE TERRACE TROUGH

size = L x D, height = H



INTEGRATED SAUCER



EASY TO MOVE



STABILISER



MADE OUT OF RECYCLED PLASTICS



SAUCER SUPPORTS PLANT

| description | | | | | | | additional information |
|---------------------------------------|-------------|------|------|------|---|-----|------------------------|
| greenville terrace trough 60cm wheels | 58.9 x 26.3 | 33.5 | 24.9 | 1.17 | 3 | 108 | |

| | art. number | | ean code | | art. number | | ean code | | art. number | | ean code |
|-----|-------------------|---|----------|-----|-------------------|---|----------|-----|-------------------|---|----------|
| 150 | 14 424 060 150 00 | 3 | | 431 | 14 424 060 431 00 | 3 | | 776 | 14 424 060 776 00 | 3 | |
| 360 | 14 424 060 360 00 | 3 | | 433 | 14 424 060 433 00 | 3 | | | | | |

| description | | | | | | | additional information |
|---------------------------------------|-------------|------|------|------|---|----|------------------------|
| greenville terrace trough 80cm wheels | 78.0 x 35.0 | 33.5 | 57.0 | 3.31 | 3 | 36 | |

| | art. number | | ean code | | art. number | | ean code | | art. number | | ean code |
|-----|-------------------|---|----------|-----|-------------------|---|----------|-----|-------------------|---|----------|
| 150 | 04 627 269 150 00 | 3 | | 431 | 04 627 269 431 00 | 3 | | 776 | 04 627 269 776 00 | 3 | |
| 360 | 04 627 269 360 00 | 3 | | 433 | 04 627 269 433 00 | 3 | | | | | |



GREENVILLE ROUND

size = L x D, height = H





| description | | | | | | | additional information |
|-----------------------|------|------|-----|------|---|-----|------------------------|
| greenville round 14cm | 14.0 | 13.4 | 1.4 | 0.12 | 5 | 600 | |

| | art. number | | ean code | | art. number | | ean code | | art. number | | ean code |
|-----|-------------------|---|----------|-----|-------------------|---|----------|-----|-------------------|---|----------|
| 150 | 30 313 014 150 00 | 5 | | 431 | 30 313 014 431 00 | 5 | | 776 | 30 313 014 776 00 | 5 | |
| 360 | 30 313 014 360 00 | 5 | | 433 | 30 313 014 433 00 | 5 | | | | | |

| description | | | | | | | additional information |
|-----------------------|------|------|-----|------|---|-----|------------------------|
| greenville round 16cm | 16.0 | 15.3 | 2.1 | 0.16 | 5 | 525 | |

| | art. number | | ean code | | art. number | | ean code | | art. number | | ean code |
|-----|-------------------|---|----------|-----|-------------------|---|----------|-----|-------------------|---|----------|
| 150 | 30 415 016 150 00 | 5 | | 431 | 30 415 016 431 00 | 5 | | 776 | 30 415 016 776 00 | 5 | |
| 360 | 30 415 016 360 00 | 5 | | 433 | 30 415 016 433 00 | 5 | | | | | |



| description | | | | | | | additional information |
|-----------------------|------|------|-----|------|---|-----|------------------------|
| greenville round 18cm | 18.3 | 17.4 | 3.2 | 0.22 | 5 | 240 | |

| | art. number | | ean code | | art. number | | ean code | | art. number | | ean code |
|-----|-------------------|---|-----------------|-----|-------------------|---|-----------------|-----|-------------------|---|-----------------|
| 150 | 30 517 018 150 00 | 5 | 8 711904 493370 | 431 | 30 517 018 431 00 | 5 | 8 711904 493431 | 776 | 30 517 018 776 00 | 5 | 8 711904 498832 |
| 360 | 30 517 018 360 00 | 5 | 8 711904 493400 | 433 | 30 517 018 433 00 | 5 | 8 711904 493462 | | | | |

| description | | | | | | | additional information |
|-----------------------|------|------|-----|------|---|-----|------------------------|
| greenville round 20cm | 19.5 | 18.4 | 3.8 | 0.23 | 5 | 240 | |







| | art. number | | ean code | | art. number | | ean code | | art. number | | ean code |
|-----|-------------------|---|-----------------|-----|-------------------|---|-----------------|-----|-------------------|---|-----------------|
| 150 | 11 118 020 150 00 | 5 | 8 711904 356804 | 431 | 11 118 020 431 00 | 5 | 8 711904 356934 | 776 | 11 118 020 776 00 | 5 | 8 711904 499082 |
| 360 | 11 118 020 360 00 | 5 | 8 711904 356873 | 433 | 11 118 020 433 00 | 5 | 8 711904 356842 | | | | |











| description | | | | | | | additional information |
|-----------------------|------|------|-----|------|---|-----|------------------------|
| greenville round 25cm | 24.5 | 23.3 | 7.6 | 0.52 | 5 | 350 | |







| | art. number | | ean code | | art. number | | ean code | | art. number | | ean code |
|-----|-------------------|---|-----------------|-----|-------------------|---|-----------------|-----|-------------------|---|-----------------|
| 150 | 04 622 624 150 00 | 5 | 8 711904 332235 | 431 | 04 622 624 431 00 | 5 | 8 711904 345716 | 776 | 04 622 624 776 00 | 5 | 8 711904 499143 |
| 360 | 04 622 624 360 00 | 5 | 8 711904 332433 | 433 | 04 622 624 433 00 | 5 | 8 711904 332334 | | | | |











| description | | | | | | | additional information |
|-----------------------|------|------|------|------|---|-----|------------------------|
| greenville round 30cm | 29.5 | 27.8 | 13.3 | 0.89 | 5 | 140 | |

| | art. number | | ean code | | art. number | | ean code | | art. number | | ean code |
|-----|-------------------|---|-----------------|-----|-------------------|---|-----------------|-----|-------------------|---|-----------------|
| 150 | 04 627 329 150 00 | 5 | 8 711904 332259 | 431 | 04 627 329 431 00 | 5 | 8 711904 345754 | 776 | 04 627 329 776 00 | 5 | 8 711904 499358 |
| 360 | 04 627 329 360 00 | 5 | 8 711904 332457 | 433 | 04 627 329 433 00 | 5 | 8 711904 332358 | | | | |

| description |  |  |  |  |  |  | additional information |
|-----------------------|-----------------------------------------------------------------------------------|-----------------------------------------------------------------------------------|-----------------------------------------------------------------------------------|------------------------------------------------------------------------------------|-------------------------------------------------------------------------------------|-------------------------------------------------------------------------------------|-------------------------------------------------------------------------------------|
| greenville round 40cm | 39.0 | 36.8 | 31.0 | 1.80 | 3 | 90 |  |

|  | art. number |  | ean code |  | art. number |  | ean code |  | art. number |  | ean code |
|-----------------------------------------------------------------------------------|-------------------|-----------------------------------------------------------------------------------|------------------------------------------------------------------------------------------------------|-----------------------------------------------------------------------------------|-------------------|-----------------------------------------------------------------------------------|-------------------------------------------------------------------------------------------------------|-------------------------------------------------------------------------------------|-------------------|-------------------------------------------------------------------------------------|--------------------------------------------------------------------------------------------------------|
| 150 | 04 636 139 150 00 | 3 |  8 711904 332273 | 431 | 04 636 139 431 00 | 3 |  8 711904 345792 | 776 | 04 636 139 776 00 | 3 |  8 711904 499396 |
| 360 | 04 636 139 360 00 | 3 |  8 711904 332471 | 433 | 04 636 139 433 00 | 3 |  8 711904 332372 | | | | |





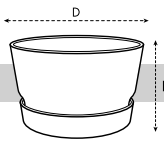

| description |  |  |  |  |  |  | additional information |
|-----------------------|-----------------------------------------------------------------------------------|-----------------------------------------------------------------------------------|-----------------------------------------------------------------------------------|------------------------------------------------------------------------------------|-------------------------------------------------------------------------------------|-------------------------------------------------------------------------------------|-------------------------------------------------------------------------------------|
| greenville round 47cm | 47.0 | 44.0 | 55.0 | 2.77 | 3 | 36 |  |











|  | art. number |  | ean code |  | art. number |  | ean code |  | art. number |  | ean code |
|-----------------------------------------------------------------------------------|-------------------|-----------------------------------------------------------------------------------|-------------------------------------------------------------------------------------------------------|-----------------------------------------------------------------------------------|-------------------|-----------------------------------------------------------------------------------|--------------------------------------------------------------------------------------------------------|-------------------------------------------------------------------------------------|-------------------|-------------------------------------------------------------------------------------|--------------------------------------------------------------------------------------------------------|
| 150 | 04 643 447 150 00 | 3 |  8 711904 332280 | 431 | 04 643 447 431 00 | 3 |  8 711904 345839 | 776 | 04 643 447 776 00 | 3 |  8 711904 499433 |
| 360 | 04 643 447 360 00 | 3 |  8 711904 332488 | 433 | 04 643 447 433 00 | 3 |  8 711904 332389 | | | | |



GREENVILLE BOWL

size = L x D, height = H

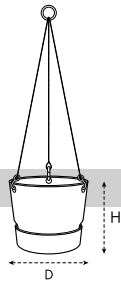

| description |  |  |  |  |  |  | additional information |
|----------------------|-------------------------------------------------------------------------------------|-------------------------------------------------------------------------------------|-------------------------------------------------------------------------------------|--------------------------------------------------------------------------------------|---------------------------------------------------------------------------------------|---------------------------------------------------------------------------------------|---------------------------------------------------------------------------------------|
| greenville bowl 33cm | 32.5 | 19.4 | 11.6 | 0.90 | 5 | 150 |  |

|  | art. number |  | ean code |  | art. number |  | ean code |  | art. number |  | ean code |
|-------------------------------------------------------------------------------------|-------------------|-------------------------------------------------------------------------------------|--------------------------------------------------------------------------------------------------------|-------------------------------------------------------------------------------------|-------------------|-------------------------------------------------------------------------------------|---------------------------------------------------------------------------------------------------------|---------------------------------------------------------------------------------------|-------------------|---------------------------------------------------------------------------------------|----------------------------------------------------------------------------------------------------------|
| 150 | 04 618 933 150 00 | 5 |  8 711904 332266 | 431 | 04 618 933 431 00 | 5 |  8 711904 345877 | 776 | 04 618 933 776 00 | 5 |  8 711904 499471 |
| 360 | 04 618 933 360 00 | 5 |  8 711904 332464 | 433 | 04 618 933 433 00 | 5 |  8 711904 332365 | | | | |



GREENVILLE HANGING BASKET

size = L x D, height = H



INTEGRATED SAUCER



MADE OUT OF RECYCLED PLASTICS



SAUCER SUPPORTS PLANT

| description | | | | | | | additional information |
|--------------------------------|------|------|-----|------|---|-----|------------------------|
| greenville hanging basket 24cm | 23.7 | 20.5 | 6.4 | 0.50 | 5 | 140 | |

| | art. number | | ean code | | art. number | | ean code | | art. number | | ean code |
|-----|-------------------|---|----------|-----|-------------------|---|----------|-----|-------------------|---|----------|
| 150 | 04 619 823 150 00 | 5 | | 431 | 04 619 823 431 00 | 5 | | 776 | 04 619 823 776 00 | 5 | |
| 360 | 04 619 823 360 00 | 5 | | 433 | 04 619 823 433 00 | 5 | | | | | |

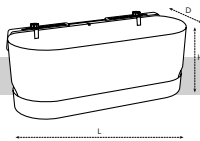

GREENVILLE EASY BALCONY



INTEGRATED SAUCER



SECURE AND STABLE



MAXIMUM RAILING WIDTH 6CM



STABILISER



MADE OUT OF RECYCLED PLASTICS



SAUCER SUPPORTS PLANT

| description | | | | | | | additional information |
|------------------------------|---|------|------|------|---|----|------------------------|
| greenville easy balcony 52cm | x | 19.4 | 15.0 | 0.76 | 5 | 70 | |

| | art. number | | ean code | | art. number | | ean code | | art. number | | ean code |
|-----|-------------------|---|----------|-----|-------------------|---|----------|-----|-------------------|---|----------|
| 150 | 30 818 052 150 00 | 5 | | 431 | 30 818 052 431 00 | 5 | | 776 | 30 818 052 776 00 | 5 | |
| 360 | 30 818 052 360 00 | 5 | | 433 | 30 818 052 433 00 | 5 | | | | | |

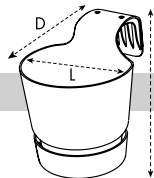

GREENVILLE EASY HANGER

size = L x D, height = H



INTEGRATED SAUCER



EASY HANGING



MADE OUT OF RECYCLED PLASTICS



SAUCER SUPPORTS PLANT

| description | | | | | | | additional information |
|-------------------------------|------|------|-----|------|---|-----|------------------------|
| greenville easy hanger single | 19.5 | 23.7 | 3.3 | 0.31 | 5 | 240 | |

| | art. number | | ean code | | art. number | | ean code | | art. number | | ean code |
|-----|-------------------|---|----------|-----|-------------------|---|----------|-----|-------------------|---|----------|
| 150 | 04 624 019 150 00 | 5 | | 431 | 04 624 019 431 00 | 5 | | 776 | 04 624 019 776 00 | 5 | |
| 360 | 04 624 019 360 00 | 5 | | 433 | 04 624 019 433 00 | 5 | | | | | |

greenville INSTORE PRESENTATIONS



GREENVILLE EASY BALCONY DISPLAY

- boost your sales: new display with innovative balcony product to inspire your shopper



| art. number | size lxd | | m ² | product | | qty. | | qty. | | qty. | ean code |
|-----------------|----------|-----|----------------|------------------------------|-----|------|-----|------|-----|------|-----------------|
| 30 800 00190110 | 60 x 80 | 100 | 0.48 | greenville easy balcony 52cm | 150 | 11 | 360 | 11 | 433 | 11 | 8 711904 509132 |

| art. number | size lxd | | m ² | product | | qty. | | qty. | | qty. | ean code |
|-----------------|----------|-----|----------------|------------------------------|-----|------|-----|------|-----|------|-----------------|
| 30 800 00190210 | 60 x 80 | 100 | 0.48 | greenville easy balcony 52cm | 360 | 11 | 431 | 11 | 433 | 11 | 8 711904 509149 |

| art. number | size lxd | | m ² | product | | qty. | | qty. | | qty. | ean code |
|-----------------|----------|-----|----------------|------------------------------|-----|------|-----|------|-----|------|-----------------|
| 30 800 00190310 | 60 x 80 | 100 | 0.48 | greenville easy balcony 52cm | 150 | 11 | 433 | 11 | 776 | 11 | 8 711904 509156 |



GREENVILLE 14, 16 & 18CM DISPLAY

- ideal second placement to introduce the greenville new sizes



| art. number | size lxd | | m ² | product | | qty. | | qty. | | qty. | ean code |
|-----------------|----------|-----|----------------|-----------------------|-----|------|-----|------|-----|------|-----------------|
| 30 300 00190110 | 60 x 40 | 160 | 0.24 | greenville round 14cm | 150 | 15 | 360 | 20 | 433 | 20 | 8 711904 509101 |
| | | | | greenville round 16cm | 150 | 10 | 360 | 10 | 433 | 15 | |
| | | | | greenville round 18cm | 150 | 8 | 360 | 8 | 433 | 8 | |

| art. number | size lxd | | m ² | product | | qty. | | qty. | | qty. | ean code |
|-----------------|----------|-----|----------------|-----------------------|-----|------|-----|------|-----|------|-----------------|
| 30 300 00190210 | 60 x 40 | 160 | 0.24 | greenville round 14cm | 360 | 20 | 431 | 15 | 433 | 20 | 8 711904 509118 |
| | | | | greenville round 16cm | 360 | 10 | 431 | 10 | 433 | 15 | |
| | | | | greenville round 18cm | 360 | 8 | 431 | 8 | 433 | 8 | |



| art. number | size lxd | | m ² | product | | qty. | | qty. | | qty. | ean code |
|-------------------|----------|-----|----------------|-----------------------|-----|------|-----|------|-----|------|---------------------|
| 30 300 001 903 10 | 60 x 40 | 160 | 0.24 | greenville round 14cm | 150 | 20 | 433 | 20 | 776 | 15 | 8 711904 509125 |
| | | | | greenville round 16cm | 150 | 15 | 433 | 10 | 776 | 10 | |
| | | | | greenville round 18cm | 150 | 8 | 433 | 8 | 776 | 8 | |



GREENVILLE 30CM DISPLAY

- #1 display for outdoor pots: a musthave for shopfloor



| art. number | size lxd | | m ² | product | | qty. | | qty. | | qty. | | qty. | ean code |
|-------------------|----------|-----|----------------|-----------------------|-----|------|-----|------|-----|------|-----|------|---------------------|
| 04 000 002 903 10 | 60 x 80 | 100 | 0.48 | greenville round 30cm | 150 | 7 | 360 | 7 | 431 | 7 | 433 | 7 | 8 711904 350987 |

| art. number | size lxd | | m ² | product | | qty. | | qty. | | qty. | | qty. | ean code |
|-------------------|----------|-----|----------------|-----------------------|-----|------|-----|------|-----|------|-----|------|---------------------|
| 46 000 004 901 10 | 60 x 80 | 100 | 0.48 | greenville round 30cm | 150 | 7 | 360 | 7 | 433 | 7 | 776 | 7 | 3 711904 508968 |



GREENVILLE 40 & 47CM ISLAND PRESENTATION

- let's seduce your shopper, stimulate the buying impulse



| art. number | size lxd | m ² | product | | qty. | | qty. | | qty. | | qty. | ean code |
|-------------------|----------|----------------|-----------------------|-----|------|-----|------|-----|------|-----|------|---------------------|
| 04 000 003 902 10 | 120 x 80 | 0.96 | greenville round 40cm | 150 | 3 | 360 | 2 | 433 | 2 | 431 | 3 | 8 711904 351014 |
| | | | greenville round 47cm | 150 | 2 | 360 | 2 | 433 | 2 | 431 | 2 | |

| art. number | size lxd | m ² | product | | qty. | | qty. | | qty. | | qty. | ean code |
|-------------------|----------|----------------|-----------------------|-----|------|-----|------|-----|------|-----|------|---------------------|
| 46 000 005 901 10 | 120 x 80 | 0.96 | greenville round 40cm | 150 | 2 | 360 | 3 | 433 | 3 | 776 | 2 | 8 711904 508982 |
| | | | greenville round 47cm | 150 | 2 | 360 | 2 | 433 | 2 | 776 | 2 | |



GREENVILLE HANGING BASKET SHELF PRESENTATION

- ideal presentation for explaining the concept and attracting the shopper



| art. number | description | size lxd | h | m ² | | ean code |
|-------------------|----------------------------------------------|----------|----|----------------|---|-----------------|
| 04 000 028 360 10 | greenville hanging basket shelf presentation | 12 x 16 | 33 | 0.17 | 1 | 8 711904 485870 |

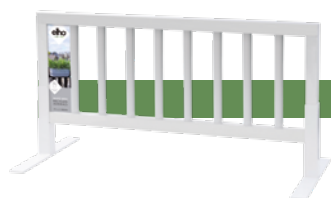

GREENVILLE PLANT TABLE BALCONY PRESENTATION

- inspire your shopper with pot-plant combinations on stand



| art. number | description | size lxd | h | m ² | | ean code |
|-------------------|----------------------------------|----------|----|----------------|---|-----------------|
| 19 100 012 150 50 | plant table balcony presentation | 100 x 47 | 62 | 0.42 | 1 | 8 711904 266974 |



LOFT URBAN

Colourful outdoor collection saucers and pots with an integrated water reservoir and hole to drain excess water. Made out of recycled plastics. Useful solutions for even the smallest outdoor spaces.



NICE THINGS TO KNOW ABOUT THE FAMILY



LOFT WATER SYSTEM



OVERFLOW PIPE



MADE OUT OF RECYCLED PLASTICS



LIGHT WEIGHT



LONG-LASTING COLOUR



FROST PROOF

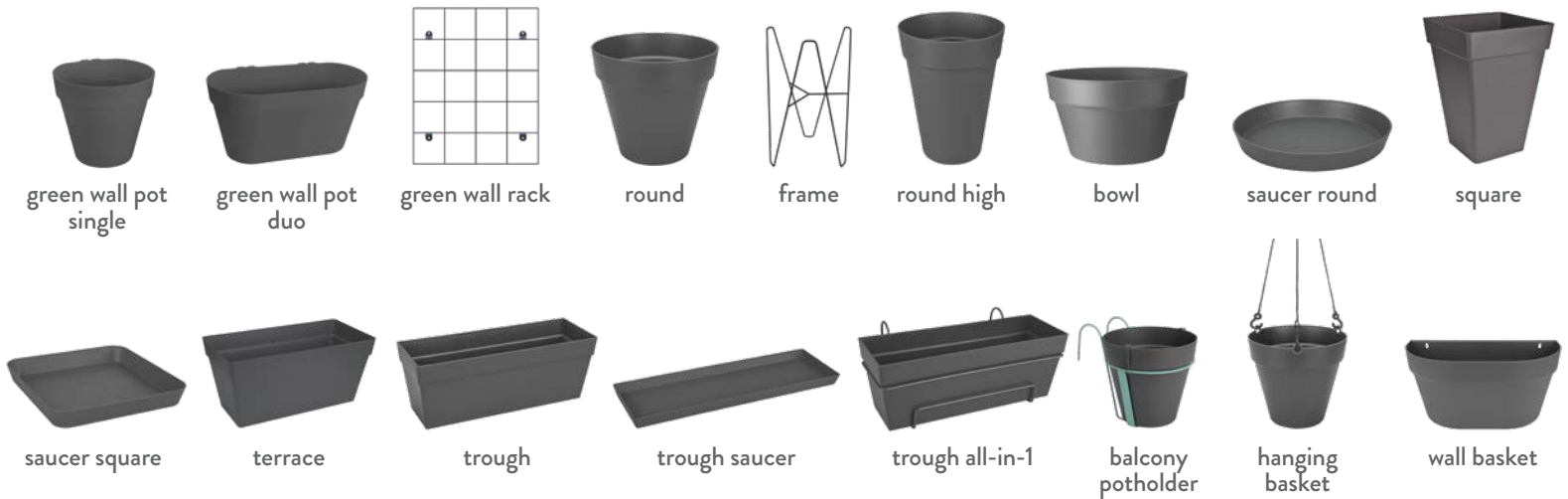

green wall pot single

green wall pot duo

green wall rack

round

frame

round high

bowl

saucer round

square

saucer square

terrace

trough

trough saucer

trough all-in-1

balcony potholder

hanging basket

wall basket



colours

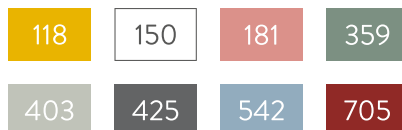

WATCH THE LOFT URBAN PRODUCT VIDEO



lofturban COLLECTION

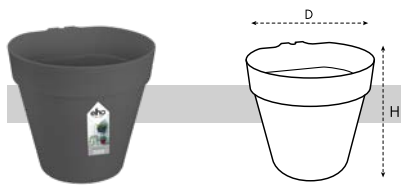

LOFT URBAN GREEN WALL POT SINGLE

size = L x D, height = H

NEW COLOUR



| description | | | | | | | additional information |
|-----------------------------------|------|------|-----|------|----|-----|------------------------|
| loft urban green wall single 15cm | 15.0 | 13.5 | 1.5 | 0.10 | 10 | 800 | |

| | art. number | | ean code | | art. number | | ean code | | art. number | | ean code |
|-----|-------------------|----|----------|-----|-------------------|----|----------|-----|-------------------|----|----------|
| 150 | 03 113 615 150 00 | 10 | | 359 | 03 113 615 359 00 | 10 | | 425 | 03 113 615 425 00 | 10 | |

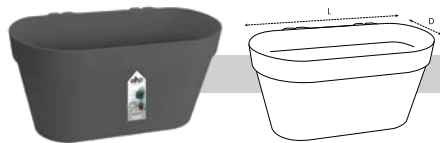

LOFT URBAN GREEN WALL POT DUO

size = L x D, height = H

NEW COLOUR



| description | | | | | | | additional information |
|--------------------------------|-------------|------|-----|------|----|-----|------------------------|
| loft urban green wall duo 28cm | 28.0 x 15.0 | 13.2 | 3.4 | 0.18 | 10 | 400 | |

| | art. number | | ean code | | art. number | | ean code | | art. number | | ean code |
|-----|-------------------|----|----------|-----|-------------------|----|----------|-----|-------------------|----|----------|
| 150 | 03 113 628 150 00 | 10 | | 359 | 03 113 628 359 00 | 10 | | 425 | 03 113 628 425 00 | 10 | |

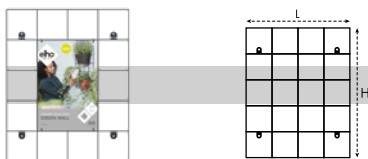

LOFT URBAN GREEN WALL RACK

size = L x D, height = H



| description | | | | | | | additional information |
|----------------------------|------|------|---|------|----|-----|------------------------|
| loft urban green wall rack | 47.3 | 59.0 | - | 0.86 | 12 | 384 | steel diameter: 4,5mm |

| | art. number | | ean code |
|-----|-------------------|----|----------|
| 433 | 03 113 699 433 00 | 12 | |

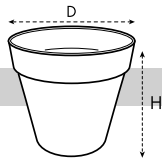

LOFT URBAN ROUND

size = L x D, height = H



| description | | | | | | | additional information |
|---------------------|------|------|-----|------|----|-----|------------------------|
| loft urban round 20 | 19.3 | 17.5 | 3.0 | 0.18 | 10 | 900 | Ø14 |

| | art. number | | ean code | | art. number | | ean code | | art. number | | ean code | | | | | | |
|--|-------------|-------------------|----------|--|-----------------|--|----------|-------------------|-------------|--|-----------------|--|-----|-------------------|----|--|-----------------|
| | 118 | 92 018 220 118 00 | 10 | | 8 711904 348502 | | 359 | 92 018 220 359 00 | 10 | | 8 711904 500474 | | 542 | 92 018 220 542 00 | 10 | | 8 711904 281342 |
| | 150 | 92 018 220 150 00 | 10 | | 8 711904 248185 | | 403 | 92 018 220 403 00 | 10 | | 8 711904 281250 | | 705 | 92 018 220 705 00 | 10 | | 8 711904 301453 |
| | 181 | 92 018 220 181 00 | 10 | | 8 711904 481339 | | 425 | 92 018 220 425 00 | 10 | | 8 711904 248246 | | | | | | |

| description | | | | | | | additional information |
|---------------------|------|------|-----|------|----|-----|------------------------|
| loft urban round 25 | 24.5 | 22.0 | 5.5 | 0.34 | 10 | 700 | Ø17 |

| | art. number | | ean code | | art. number | | ean code | | art. number | | ean code | | | | | | |
|--|-------------|-------------------|----------|--|-----------------|--|----------|-------------------|-------------|--|-----------------|--|-----|-------------------|----|--|-----------------|
| | 118 | 92 022 224 118 00 | 10 | | 8 711904 348533 | | 359 | 92 022 224 359 00 | 10 | | 8 711904 500504 | | 542 | 92 022 224 542 00 | 10 | | 8 711904 281526 |
| | 150 | 92 022 224 150 00 | 10 | | 8 711904 230234 | | 403 | 92 022 224 403 00 | 10 | | 8 711904 281434 | | 705 | 92 022 224 705 00 | 10 | | 8 711904 301545 |
| | 181 | 92 022 224 181 00 | 10 | | 8 711904 481490 | | 425 | 92 022 224 425 00 | 10 | | 8 711904 230296 | | | | | | |

| description | | | | | | | additional information |
|---------------------|------|------|-----|------|---|-----|------------------------|
| loft urban round 30 | 28.5 | 26.0 | 9.6 | 0.53 | 5 | 280 | Ø21 |

| | art. number | | ean code | | art. number | | ean code | | art. number | | ean code | | | | | | |
|--|-------------|-------------------|----------|--|-----------------|--|----------|-------------------|-------------|--|-----------------|--|-----|-------------------|---|--|-----------------|
| | 118 | 92 026 290 118 00 | 5 | | 8 711904 348564 | | 359 | 92 026 290 359 00 | 5 | | 8 711904 500535 | | 542 | 92 026 290 542 00 | 5 | | 8 711904 281946 |
| | 150 | 92 026 290 150 00 | 5 | | 8 711904 184209 | | 403 | 92 026 290 403 00 | 5 | | 8 711904 281854 | | 705 | 92 026 290 705 00 | 5 | | 8 711904 301729 |
| | 181 | 92 026 290 181 00 | 5 | | 8 711904 481537 | | 425 | 92 026 290 425 00 | 5 | | 8 711904 184230 | | | | | | |



| description | | | | | | | additional information |
|----------------------------|------|------|------|------|---|-----|------------------------|
| loft urban round wheels 40 | 38.5 | 35.3 | 24.0 | 1.25 | 5 | 150 | |

| | art. number | | ean code | | art. number | | ean code | | art. number | | ean code |
|--|-------------------|---|----------|--|-------------------|---|----------|--|-------------------|---|----------|
| | 92 035 390 118 00 | 5 | | | 92 035 390 359 00 | 5 | | | 92 035 390 542 00 | 5 | |
| | 92 035 390 150 00 | 5 | | | 92 035 390 403 00 | 5 | | | 92 035 390 705 00 | 5 | |
| | 92 035 390 181 00 | 5 | | | 92 035 390 425 00 | 5 | | | | | |

| description | | | | | | | additional information |
|----------------------------|------|------|------|------|---|----|------------------------|
| loft urban round wheels 50 | 48.5 | 44.5 | 48.0 | 2.03 | 5 | 30 | |

| | art. number | | ean code | | art. number | | ean code | | art. number | | ean code |
|--|-------------------|---|----------|--|-------------------|---|----------|--|-------------------|---|----------|
| | 92 442 490 118 00 | 5 | | | 92 442 490 359 00 | 5 | | | 92 442 490 542 00 | 5 | |
| | 92 442 490 150 00 | 5 | | | 92 442 490 403 00 | 5 | | | 92 442 490 705 00 | 5 | |
| | 92 442 490 181 00 | 5 | | | 92 442 490 425 00 | 5 | | | | | |

| description | | | | | | | additional information |
|----------------------------|------|------|------|------|---|----|------------------------|
| loft urban round wheels 60 | 58.0 | 54.0 | 85.0 | 3.29 | 3 | 30 | |

| | art. number | | ean code | | art. number | | ean code | | art. number | | ean code |
|--|-------------------|---|----------|--|-------------------|---|----------|--|-------------------|---|----------|
| | 92 453 459 150 00 | 3 | | | 92 453 459 403 00 | 3 | | | 92 453 459 425 00 | 3 | |

| description | | | | | | | additional information |
|---------------------|------|------|-------|------|---|----|------------------------|
| loft urban round 70 | 69.0 | 62.5 | 128.0 | 4.76 | 1 | 10 | |

| | art. number | | ean code | | art. number | | ean code | | art. number | | ean code |
|--|-------------------|---|----------|--|-------------------|---|----------|--|-------------------|---|----------|
| | 92 462 470 150 00 | 1 | | | 92 462 470 403 00 | 1 | | | 92 462 470 425 00 | 1 | |

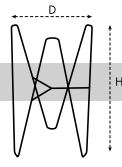

LOFT URBAN FRAME

size = L x D, height = H



| description | Ø | ↓ | Ltr | Kg | ☞ | 📦 | additional information |
|-----------------------|------|------|-----|------|----|-----|------------------------|
| loft urban frame 30cm | 26.5 | 39.0 | - | 0.66 | 10 | 280 | max. 10kg |

| art. number | ☞ | ean code | art. number | ☞ | ean code | art. number | ☞ | ean code |
|-------------|-------------------|-----------------|-------------|-------------------|-----------------|-------------|-------------------|-----------------|
| 433 | 92 039 025 433 00 | 10 | 555 | 92 039 025 555 00 | 10 | 764 | 92 039 025 764 00 | 10 |
| | | | | | | | | |
| | | 8 711904 316822 | | | 8 711904 316846 | | | 8 711904 316860 |

| description | Ø | ↓ | Ltr | Kg | ☞ | 📦 | additional information |
|-----------------------|------|------|-----|------|----|-----|------------------------|
| loft urban frame 40cm | 36.0 | 51.3 | - | 0.80 | 10 | 180 | max. 25kg |

| art. number | ☞ | ean code | art. number | ☞ | ean code | art. number | ☞ | ean code |
|-------------|-------------------|-----------------|-------------|-------------------|-----------------|-------------|-------------------|-----------------|
| 433 | 92 051 033 433 00 | 10 | 555 | 92 051 033 555 00 | 10 | 764 | 92 051 033 764 00 | 10 |
| | | | | | | | | |
| | | 8 711904 316884 | | | 8 711904 316907 | | | 8 711904 316921 |

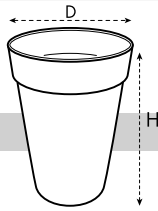

LOFT URBAN ROUND HIGH

size = L x D, height = H

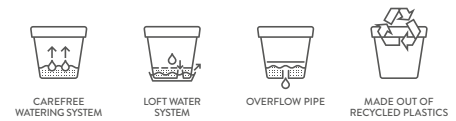

| description | Ø | ↓ | Ltr | Kg | ☞ | 📦 | additional information |
|--------------------------|------|------|------|------|---|-----|------------------------|
| loft urban round high 28 | 27.5 | 35.8 | 12.0 | 0.69 | 5 | 275 | Ø21 |

| art. number | ☞ | ean code | art. number | ☞ | ean code | art. number | ☞ | ean code |
|-------------|-------------------|-----------------|-------------|-------------------|-----------------|-------------|-------------------|-----------------|
| 118 | 92 436 328 118 00 | 5 | 359 | 92 436 328 359 00 | 5 | 425 | 92 436 328 425 00 | 5 |
| | | | | | | | | |
| | | 8 711904 495008 | | | 8 711904 500627 | | | 8 711904 231125 |
| 150 | 92 436 328 150 00 | 5 | 403 | 92 436 328 403 00 | 5 | 542 | 92 436 328 542 00 | 5 |
| | | | | | | | | |
| | | 8 711904 231064 | | | 8 711904 282905 | | | 8 711904 282936 |
| 181 | 92 436 328 181 00 | 5 | | | | | | |
| | | | | | | | | |
| | | 8 711904 495039 | | | | | | |



| description | | | | | | | additional information |
|--------------------------|------|------|------|------|---|-----|------------------------|
| loft urban round high 35 | 33.5 | 45.3 | 23.0 | 1.03 | 5 | 210 | Ø24 |

| | art. number | | ean code | | art. number | | ean code | | art. number | | ean code | | | |
|--|-------------|-------------------|----------|--|-------------|-----|-------------------|---|-------------|--|----------|-------------------|---|--|
| | 118 | 92 445 339 118 00 | 5 | | | 359 | 92 445 339 359 00 | 5 | | | 542 | 92 445 339 542 00 | 5 | |
| | 150 | 92 445 339 150 00 | 5 | | | 403 | 92 445 339 403 00 | 5 | | | 705 | 92 445 339 705 00 | 5 | |
| | 181 | 92 436 328 181 00 | 5 | | | 425 | 92 445 339 425 00 | 5 | | | | | | |

| description | | | | | | | additional information |
|--------------------------|------|------|------|------|---|----|------------------------|
| loft urban round high 42 | 42.0 | 56.0 | 45.0 | 1.93 | 5 | 80 | Ø30 |

| | art. number | | ean code | | art. number | | ean code | | art. number | | ean code | | | |
|--|-------------|-------------------|----------|--|-------------|-----|-------------------|---|-------------|--|----------|-------------------|---|--|
| | 150 | 92 564 421 150 00 | 5 | | | 425 | 92 564 421 425 00 | 5 | | | 705 | 92 564 421 705 00 | 5 | |
| | 403 | 92 564 421 403 00 | 5 | | | | | | | | | | | |

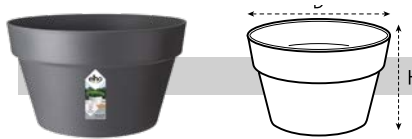

LOFT URBAN BOWL

size = L x D, height = H

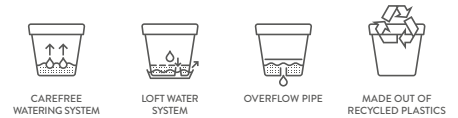

| description | | | | | | | additional information |
|--------------------|------|------|------|------|---|-----|------------------------|
| loft urban bowl 35 | 34.5 | 20.2 | 13.0 | 0.72 | 5 | 150 | Ø28 |

| | art. number | | ean code | | art. number | | ean code | | art. number | | ean code | | | |
|--|-------------|-------------------|----------|--|-------------|-----|-------------------|---|-------------|--|----------|-------------------|---|--|
| | 118 | 91 820 035 118 00 | 5 | | | 359 | 91 820 035 359 00 | 5 | | | 425 | 91 820 035 425 00 | 5 | |
| | 150 | 91 820 035 150 00 | 5 | | | 403 | 91 820 035 403 00 | 5 | | | 542 | 91 820 035 542 00 | 5 | |
| | 181 | 91 820 035 181 00 | 5 | | | | | | | | | | | |



LOFT URBAN SAUCER ROUND

size = L x D, height = H
for matching products, see p. 326-327



| description | | | | | | | additional information |
|----------------------------|------|-----|---|------|---|------|----------------------------------|
| loft urban saucer round 14 | 14.0 | 1.9 | - | 0.04 | 5 | 5175 | can be used for vibia family too |

| | art. number | | ean code | | art. number | | ean code | | art. number | | ean code |
|-----|-------------------|---|----------|-----|-------------------|---|----------|-----|-------------------|---|----------|
| 118 | 92 002 214 118 00 | 5 | | 359 | 92 002 214 359 00 | 5 | | 451 | 92 002 214 451 00 | 5 | |
| 125 | 92 002 214 125 00 | 5 | | 403 | 92 002 214 403 00 | 5 | | 542 | 92 002 214 542 00 | 5 | |
| 150 | 92 002 214 150 00 | 5 | | 425 | 92 002 214 425 00 | 5 | | 560 | 92 002 214 560 00 | 5 | |
| 181 | 92 002 214 181 00 | 5 | | 431 | 92 002 214 431 00 | 5 | | 705 | 92 002 214 705 00 | 5 | |
| 270 | 92 002 214 270 00 | 5 | | | | | | | | | |

| description | | | | | | | additional information |
|----------------------------|------|-----|---|------|---|------|----------------------------------|
| loft urban saucer round 17 | 17.3 | 2.4 | - | 0.05 | 5 | 3000 | can be used for vibia family too |

| | art. number | | ean code | | art. number | | ean code | | art. number | | ean code |
|-----|-------------------|---|----------|-----|-------------------|---|----------|-----|-------------------|---|----------|
| 118 | 92 024 325 118 00 | 5 | | 359 | 92 024 325 359 00 | 5 | | 451 | 92 024 325 451 00 | 5 | |
| 125 | 92 024 325 125 00 | 5 | | 403 | 92 024 325 403 00 | 5 | | 542 | 92 024 325 542 00 | 5 | |
| 150 | 92 024 325 150 00 | 5 | | 425 | 92 024 325 425 00 | 5 | | 560 | 92 024 325 560 00 | 5 | |
| 181 | 92 024 325 181 00 | 5 | | 431 | 92 024 325 431 00 | 5 | | 705 | 92 024 325 705 00 | 5 | |
| 270 | 92 024 325 270 00 | 5 | | | | | | | | | |



| description | | | | | | | additional information |
|----------------------------|------|-----|---|------|---|------|----------------------------------|
| loft urban saucer round 21 | 20.4 | 2.9 | - | 0.08 | 5 | 1700 | can be used for vibia family too |

| | art. number | | ean code | | art. number | | ean code | | art. number | | ean code |
|-----|-------------------|---|-----------------|-----|-------------------|---|-----------------|-----|-------------------|---|-----------------|
| 118 | 92 209 029 118 00 | 5 | 8 711904 348687 | 359 | 92 209 029 359 00 | 5 | 8 711904 500832 | 451 | 92 209 029 451 00 | 5 | 8 711904 495732 |
| 125 | 92 209 029 125 00 | 5 | 8 711904 500863 | 403 | 92 209 029 403 00 | 5 | 8 711904 282219 | 542 | 92 209 029 542 00 | 5 | 8 711904 282301 |
| 150 | 92 209 029 150 00 | 5 | 8 711904 186234 | 425 | 92 209 029 425 00 | 5 | 8 711904 186265 | 560 | 92 209 029 560 00 | 5 | 8 711904 481896 |
| 181 | 92 209 029 181 00 | 5 | 8 711904 481810 | 431 | 92 209 029 431 00 | 5 | 8 711904 337100 | 705 | 92 209 029 705 00 | 5 | 8 711904 301903 |
| 270 | 92 209 029 270 00 | 5 | 8 711904 481858 | | | | | | | | |

| description | | | | | | | additional information |
|----------------------------|------|-----|---|------|---|------|----------------------------------|
| loft urban saucer round 24 | 24.4 | 3.4 | - | 0.12 | 5 | 1120 | can be used for vibia family too |

| | art. number | | ean code | | art. number | | ean code | | art. number | | ean code |
|-----|-------------------|---|-----------------|-----|-------------------|---|-----------------|-----|-------------------|---|-----------------|
| 118 | 92 235 033 118 00 | 5 | 8 711904 348748 | 359 | 92 235 033 359 00 | 5 | 8 711904 500986 | 451 | 92 235 033 451 00 | 5 | 8 711904 495916 |
| 125 | 92 235 033 125 00 | 5 | 8 711904 501013 | 403 | 92 235 033 403 00 | 5 | 8 711904 282394 | 542 | 92 235 033 542 00 | 5 | 8 711904 282486 |
| 150 | 92 235 033 150 00 | 5 | 8 711904 186296 | 425 | 92 235 033 425 00 | 5 | 8 711904 186326 | 560 | 92 235 033 560 00 | 5 | 8 711904 482015 |
| 181 | 92 235 033 181 00 | 5 | 8 711904 481933 | 431 | 92 235 033 431 00 | 5 | 8 711904 337117 | 705 | 92 235 033 705 00 | 5 | 8 711904 301996 |
| 270 | 92 235 033 270 00 | 5 | 8 711904 481971 | | | | | | | | |



| description | | | | | | | additional information |
|----------------------------|------|-----|---|------|---|-----|----------------------------------|
| loft urban saucer round 28 | 27.5 | 3.5 | - | 0.16 | 5 | 825 | can be used for vibia family too |

| | art. number | | ean code | | art. number | | ean code | | art. number | | ean code |
|--|-------------------|---|----------|--|-------------------|---|----------|--|-------------------|---|----------|
| | 92 277 037 118 00 | 5 | | | 92 277 037 359 00 | 5 | | | 92 277 037 451 00 | 5 | |
| | 92 277 037 125 00 | 5 | | | 92 277 037 403 00 | 5 | | | 92 277 037 542 00 | 5 | |
| | 92 277 037 150 00 | 5 | | | 92 277 037 425 00 | 5 | | | 92 277 037 560 00 | 5 | |
| | 92 277 037 181 00 | 5 | | | 92 277 037 431 00 | 5 | | | 92 277 037 705 00 | 5 | |
| | 92 277 037 270 00 | 5 | | | | | | | | | |

| description | | | | | | | additional information |
|----------------------------|------|-----|---|------|---|-----|----------------------------------|
| loft urban saucer round 30 | 30.2 | 4.1 | - | 0.21 | 5 | 600 | can be used for vibia family too |

| | art. number | | ean code | | art. number | | ean code | | art. number | | ean code |
|--|-------------------|---|----------|--|-------------------|---|----------|--|-------------------|---|----------|
| | 92 298 040 125 00 | 5 | | | 92 298 040 425 00 | 5 | | | 92 298 040 560 00 | 5 | |
| | 92 298 040 150 00 | 5 | | | 92 298 040 431 00 | 5 | | | 92 298 040 705 00 | 5 | |
| | 92 298 040 270 00 | 5 | | | 92 298 040 451 00 | 5 | | | | | |

| description | | | | | | | additional information |
|----------------------------|------|-----|---|------|---|-----|----------------------------------|
| loft urban saucer round 34 | 34.3 | 5.0 | - | 0.29 | 5 | 420 | can be used for vibia family too |

| | art. number | | ean code | | art. number | | ean code | | art. number | | ean code |
|--|-------------------|---|----------|--|-------------------|---|----------|--|-------------------|---|----------|
| | 92 345 046 118 00 | 5 | | | 92 345 046 359 00 | 5 | | | 92 345 046 451 00 | 5 | |
| | 92 345 046 150 00 | 5 | | | 92 345 046 403 00 | 5 | | | 92 345 046 542 00 | 5 | |
| | 92 345 046 181 00 | 5 | | | 92 345 046 425 00 | 5 | | | 92 345 046 560 00 | 5 | |
| | 92 345 046 270 00 | 5 | | | 92 345 046 431 00 | 5 | | | 92 345 046 705 00 | 5 | |



| description | | | | | | | additional information |
|----------------------------|------|-----|---|------|---|-----|----------------------------------|
| loft urban saucer round 41 | 41.0 | 5.2 | - | 0.43 | 5 | 260 | can be used for vibia family too |

| | art. number | | ean code | | art. number | | ean code | | art. number | | ean code |
|-----|-------------------|---|-----------------|-----|-------------------|---|-----------------|-----|-------------------|---|-----------------|
| 150 | 92 353 059 150 00 | 5 | 8 711904 200572 | 425 | 92 353 059 425 00 | 5 | 8 711904 200633 | 451 | 92 353 059 451 00 | 5 | 8 711904 495947 |
| 270 | 92 353 059 270 00 | 5 | 8 711904 482251 | 431 | 92 353 059 431 00 | 5 | 8 711904 337155 | 560 | 92 353 059 560 00 | 5 | 8 711904 482299 |

| description | | | | | | | additional information |
|----------------------------|------|-----|---|------|---|-----|------------------------|
| loft urban saucer round 48 | 47.7 | 5.4 | - | 0.62 | 5 | 185 | |

| | art. number | | ean code | | art. number | | ean code | | art. number | | ean code |
|-----|-------------------|---|-----------------|-----|-------------------|---|-----------------|-----|-------------------|---|-----------------|
| 150 | 92 505 048 150 00 | 5 | 8 711904 238667 | 403 | 92 505 048 403 00 | 5 | 8 711904 283315 | 425 | 92 505 048 425 00 | 5 | 8 711904 238742 |

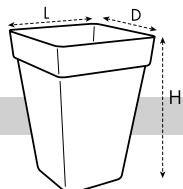

LOFT URBAN SQUARE HIGH

size = L x D, height = H

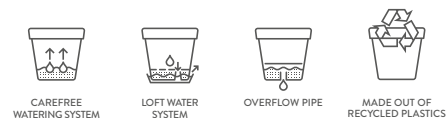

| description | | | | | | | additional information |
|---------------------------|-------------|------|------|------|---|-----|------------------------|
| loft urban square high 30 | 29.3 x 29.3 | 41.3 | 19.0 | 1.09 | 5 | 200 | 22 |

| | art. number | | ean code | | art. number | | ean code |
|-----|-------------------|---|-----------------|-----|-------------------|---|-----------------|
| 150 | 92 741 029 150 00 | 5 | 8 711904 230395 | 425 | 92 741 029 425 00 | 5 | 8 711904 230456 |

| description | | | | | | | additional information |
|---------------------------|-------------|------|------|------|---|-----|------------------------|
| loft urban square high 37 | 37.0 x 37.0 | 51.3 | 39.0 | 1.83 | 5 | 150 | 28 |

| | art. number | | ean code | | art. number | | ean code |
|-----|-------------------|---|-----------------|-----|-------------------|---|-----------------|
| 150 | 92 751 036 150 00 | 5 | 8 711904 230555 | 425 | 92 751 036 425 00 | 5 | 8 711904 230616 |

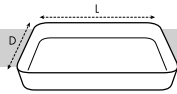

LOFT URBAN SAUCER SQUARE

size = L x D, height = H
for matching products, see p. 326-327



| description | | | | | | | additional information |
|-----------------------------|-------------|-----|---|------|---|------|----------------------------------|
| loft urban saucer square 22 | 22.0 x 22.0 | 3.1 | - | 0.10 | 5 | 1500 | can be used for vibia family too |

| | art. number | | ean code | | art. number | | ean code | | art. number | | ean code |
|-----|-------------------|---|----------|-----|-------------------|---|----------|-----|-------------------|---|----------|
| 150 | 92 703 122 150 00 | 5 | | 425 | 92 703 122 425 00 | 5 | | 451 | 92 703 122 451 00 | 5 | |
| 270 | 92 703 122 270 00 | 5 | | 431 | 92 703 122 431 00 | 5 | | 560 | 92 703 122 560 00 | 5 | |

| description | | | | | | | additional information |
|-----------------------------|-------------|-----|---|------|---|-----|----------------------------------|
| loft urban saucer square 28 | 27.5 x 27.5 | 3.8 | - | 0.20 | 5 | 820 | can be used for vibia family too |

| | art. number | | ean code | | art. number | | ean code | | art. number | | ean code |
|-----|-------------------|---|----------|-----|-------------------|---|----------|-----|-------------------|---|----------|
| 150 | 92 704 128 150 00 | 5 | | 425 | 92 704 128 425 00 | 5 | | 451 | 92 704 128 451 00 | 5 | |
| 270 | 92 704 128 270 00 | 5 | | 431 | 92 704 128 431 00 | 5 | | 560 | 92 704 128 560 00 | 5 | |

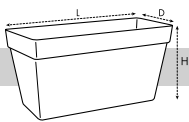

LOFT URBAN TERRACE

size = L x D, height = H



| description | | | | | | | additional information |
|------------------------------|-------------|------|------|------|---|----|------------------------|
| loft urban terrace wheels 70 | 69.3 x 33.8 | 32.5 | 51.0 | 2.62 | 3 | 54 | |

| | art. number | | ean code | | art. number | | ean code |
|-----|-------------------|---|----------|-----|-------------------|---|----------|
| 150 | 92 732 269 150 00 | 3 | | 425 | 92 732 269 425 00 | 3 | |

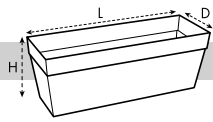

LOFT URBAN TROUGH

size = L x D, height = H



| description | | | | | | | additional information |
|----------------------|-------------|------|------|------|---|-----|------------------------|
| loft urban trough 50 | 49.3 x 16.8 | 18.0 | 10.0 | 0.88 | 5 | 270 | 50 |

| | art. number | | ean code | | art. number | | ean code |
|-----|-------------------|---|----------|-----|-------------------|---|----------|
| 150 | 92 442 442 150 00 | 5 | | 425 | 92 442 442 425 00 | 5 | |

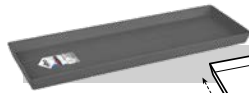

LOFT URBAN TROUGH SAUCER

size = L x D, height = H



| description | | | | | | | additional information |
|-----------------------------|-------------|-----|---|------|---|-----|------------------------|
| loft urban trough saucer 50 | 47.3 x 15.3 | 2.6 | - | 0.20 | 5 | 935 | |

| | art. number | | ean code | | art. number | | ean code |
|-----|-------------------|---|----------|-----|-------------------|---|----------|
| 150 | 92 025 470 150 00 | 5 | | 425 | 92 025 470 425 00 | 5 | |

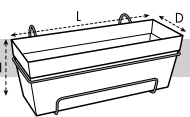

LOFT URBAN TROUGH ALL-IN-1

size = L x D, height = H



| description | | | | | | | additional information |
|-------------------------------|-------------|------|------|------|---|-----|------------------------|
| loft urban trough all-in-1 50 | 49.0 x 26.5 | 20.5 | 11.5 | 1.44 | 5 | 105 | |

| | art. number | | ean code | | art. number | | ean code |
|-----|-------------------|---|----------|-----|-------------------|---|----------|
| 150 | 92 205 478 150 00 | 5 | | 425 | 92 205 478 425 00 | 5 | |



LOFT URBAN BALCONY POTHOLDER

size = L x D, height = H

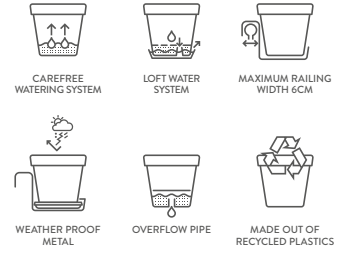

| description | | | | | | | additional information |
|------------------------------|-------------|------|-----|------|---|-----|------------------------|
| loft urban balcony potholder | 28.0 x 19.3 | 20.0 | 3.0 | 0.43 | 8 | 288 | |

| | art. number | | ean code | | art. number | | ean code |
|------------|-------------------|---|-----------------|------------|-------------------|---|-----------------|
| 150 623 | 91 720 027 150 00 | 8 | 8 711904 273330 | 425 623 | 91 720 027 425 00 | 8 | 8 711904 273453 |



LOFT URBAN WALL BASKET

size = L x D, height = H

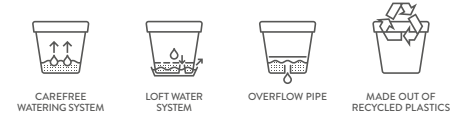

| description | | | | | | | additional information |
|---------------------------|-------------|------|-----|------|---|-----|------------------------|
| loft urban wall basket 40 | 39.3 x 19.8 | 18.8 | 8.3 | 0.53 | 5 | 180 | |

| | art. number | | ean code | | art. number | | ean code |
|-----|-------------------|---|-----------------|-----|-------------------|---|-----------------|
| 150 | 92 918 539 150 00 | 5 | 8 711904 246914 | 425 | 92 918 539 425 00 | 5 | 8 711904 246976 |

lofturban INSTORE PRESENTATIONS



LOFT URBAN GREEN WALL CONCEPT STAND

- ideal inspirational one stop shopping concept - stand is including content!

NEW
COLOUR

INCL.
CONTENT



STAND INCLUDING CONTENT

| art. number | description | size lxd | h | m ² | | ean code |
|-------------------|-------------------------------------|----------|-----|----------------|---|------------------|
| 19 100 040 150 50 | loft urban green wall concept stand | 78 x 80 | 198 | 0.62 | 1 | 8 711904 1523909 |

| product | | qty. | | qty. | | qty. |
|------------------------------|-----|------|-----|------|-----|------|
| loft urban green wall single | 150 | 40 | 359 | 40 | 425 | 40 |
| loft urban green wall duo | 150 | 20 | 425 | 20 | | |
| loft urban green wall rack | 433 | 24 | | | | |



LOFT URBAN ROUND 30 DISPLAY

- ideal presentation to boost your seasonal and colourful sales



| art. number | size lxd | | m ² | product | | qty. | | qty. | | qty. | | qty. | ean code |
|-------------------|----------|-----|----------------|---------------------|-----|------|-----|------|-----|------|-----|------|-----------------|
| 92 000 037 905 10 | 60 x 80 | 100 | 0.48 | loft urban round 30 | 150 | 14 | 403 | 14 | 425 | 14 | 542 | 14 | 8 711904 485184 |

| art. number | size lxd | | m ² | product | | qty. | | qty. | | qty. | | qty. | ean code |
|-------------------|----------|-----|----------------|---------------------|-----|------|-----|------|-----|------|-----|------|-----------------|
| 92 000 042 906 10 | 60 x 80 | 100 | 0.48 | loft urban round 30 | 118 | 14 | 150 | 14 | 359 | 14 | 425 | 14 | 8 711904 508685 |

| art. number | size lxd | | m ² | product | | qty. | | qty. | | qty. | | qty. | ean code |
|-------------------|----------|-----|----------------|---------------------|-----|------|-----|------|-----|------|-----|------|-----------------|
| 92 000 042 907 10 | 60 x 80 | 100 | 0.48 | loft urban round 30 | 118 | 14 | 181 | 14 | 359 | 14 | 425 | 14 | 8 711904 508692 |



LOFT URBAN ROUND WITH LOFT URBAN FRAME



CORSICA

Our classic hero collection turns your balcony, rooftop or terrace into a sustainable plant oasis. Easy plant care solutions made out of recycled plastics in 4 different colours.



NICE THINGS TO KNOW ABOUT THE FAMILY



FITS EVERY BALCONY



SAUCER SUPPORTS PLANT



OVERFLOW PIPE



MADE OUT OF RECYCLED PLASTICS



LIGHT WEIGHT



LONG-LASTING COLOUR



FROST PROOF



vertical forest small



vertical forest large



flower bridge 30cm



flower bridge 60cm



easy hanger single



easy hanger trio



easy balcony

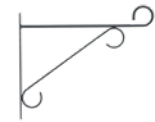

wall hook elegance

BEST SELLING PRODUCT

corsica flower bridge
30 & 60cm

colours

150

410

425

623



WATCH THE VERTICAL FOREST PRODUCT VIDEO



corsica COLLECTION

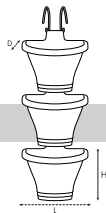

CORSICA VERTICAL FOREST SMALL

size = L x D, height = H



| description | | | | | | | additional information |
|-------------------------------|-------------|------|--------|------|---|-----|---------------------------------------------------------------------------------|
| corsica vertical forest set/3 | 24.3 x 16.7 | 69.0 | 3 x 2L | 0.60 | 6 | 264 | measurements for complete set incl. hooks. Both balcony and wall hooks included |

| | art. number | | ean code | | art. number | | ean code | | art. number | | ean code |
|-----|-------------------|---|----------|-----|-------------------|---|----------|-----|-------------------|---|----------|
| 150 | 04 721 124 150 00 | 6 | | 425 | 04 721 124 425 00 | 6 | | 623 | 04 721 124 623 00 | 6 | |

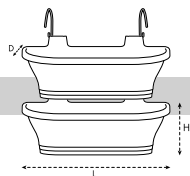

CORSICA VERTICAL FOREST LARGE

size = L x D, height = H



| description | | | | | | | additional information |
|---------------------------------|-------------|------|--------|------|---|-----|---------------------------------------------------------------------------------|
| corsica vert forest large set/2 | 51.2 x 16.7 | 48.3 | 2 x 7L | 0.80 | 4 | 108 | measurements for complete set incl. hooks. Both balcony and wall hooks included |

| | art. number | | ean code | | art. number | | ean code | | art. number | | ean code |
|-----|-------------------|---|----------|-----|-------------------|---|----------|-----|-------------------|---|----------|
| 150 | 16 117 051 150 00 | 4 | | 425 | 16 117 051 425 00 | 4 | | 623 | 16 117 051 623 00 | 4 | |

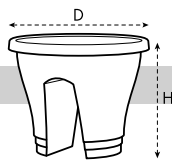

CORSICA FLOWER BRIDGE

size = L x D, height = H



| description | | | | | | | additional information |
|----------------------------|------|------|-----|------|---|-----|------------------------|
| corsica flower bridge 30cm | 29.0 | 23.8 | 6.5 | 0.43 | 5 | 400 | |

| | art. number | | ean code | | art. number | | ean code | | art. number | | ean code |
|-----|-------------------|---|----------|-----|-------------------|---|----------|-----|-------------------|---|----------|
| 150 | 74 324 230 150 00 | 5 | | 425 | 74 324 230 425 00 | 5 | | 623 | 74 324 230 623 00 | 5 | |
| 410 | 74 324 230 410 00 | 5 | | | | | | | | | |



CORSICA FLOWER BRIDGE

size = L x D, height = H



| description | | | | | | | additional information |
|----------------------------|-------------|------|------|------|---|-----|------------------------|
| corsica flower bridge 60cm | 57.3 x 28.3 | 23.8 | 18.0 | 0.84 | 5 | 200 | |

| | art. number | | ean code | | art. number | | ean code | | art. number | | ean code |
|-----|-------------------|---|----------|-----|-------------------|---|----------|-----|-------------------|---|----------|
| 150 | 74 324 258 150 00 | 5 | | 425 | 74 324 258 425 00 | 5 | | 623 | 74 324 258 623 00 | 5 | |
| 410 | 74 324 258 410 00 | 5 | | | | | | | | | |

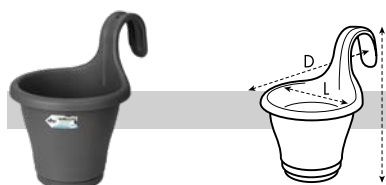

CORSICA EASY HANGER SINGLE

size = L x D, height = H

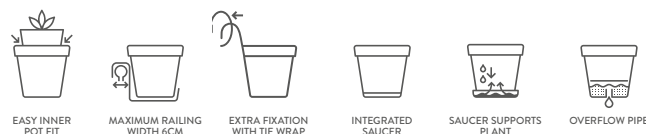

| description | | | | | | | additional information |
|----------------------------|-------------|------|-----|------|---|-----|------------------------|
| corsica easy hanger single | 26.5 x 19.0 | 26.3 | 2.4 | 0.20 | 5 | 660 | |

| | art. number | | ean code | | art. number | | ean code | | art. number | | ean code |
|-----|-------------------|---|----------|-----|-------------------|---|----------|-----|-------------------|---|----------|
| 150 | 75 426 027 150 00 | 5 | | 425 | 75 426 027 425 00 | 5 | | 623 | 75 426 027 623 00 | 5 | |
| 410 | 75 426 027 410 00 | 5 | | | | | | | | | |



CORSICA EASY HANGER TRIO

size = L x D, height = H

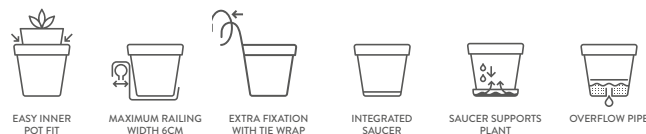

| description | | | | | | | additional information |
|--------------------------|-------------|------|-----|------|---|-----|------------------------|
| corsica easy hanger trio | 53.0 x 27.5 | 27.0 | 8.0 | 0.62 | 5 | 175 | |

| | art. number | | ean code | | art. number | | ean code | | art. number | | ean code |
|-----|-------------------|---|----------|-----|-------------------|---|----------|-----|-------------------|---|----------|
| 150 | 75 426 553 150 00 | 5 | | 425 | 75 426 553 425 00 | 5 | | 623 | 75 426 553 623 00 | 5 | |
| 410 | 75 426 553 410 00 | 5 | | | | | | | | | |

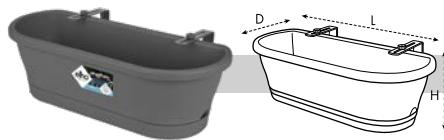

CORSICA EASY BALCONY

size = L x D, height = H



| description | | | | | | | additional information |
|-------------------------|-------------|------|------|------|---|-----|------------------------|
| corsica easy balcony 60 | 57.5 x 24.0 | 19.0 | 15.0 | 1.28 | 5 | 120 | supports max. 25kg |

| | art. number | | ean code | | art. number | | ean code | | art. number | | ean code |
|-----|-------------------|---|----------|-----|-------------------|---|----------|-----|-------------------|---|----------|
| 150 | 73 616 059 150 01 | 5 | | 425 | 73 616 059 425 01 | 5 | | 623 | 73 616 059 623 01 | 5 | |
| 410 | 73 616 059 410 01 | 5 | | | | | | | | | |

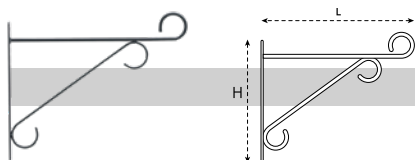

WALL HOOK ELEGANCE

size = L x D, height = H



| description | | | | | | | additional information |
|-------------------------|------------|------|---|------|----|-----|------------------------|
| wall hook elegance 30cm | 30.0 x 3.0 | 26.0 | - | 0.31 | 12 | 576 | supports max. 16kg |

| | art. number | | ean code |
|-----|-------------------|----|----------|
| 425 | 11 801 016 425 00 | 12 | |

corsica INSTORE PRESENTATIONS



CORSICA VERTICAL FOREST SMALL & LARGE DISPLAY

- unique balcony concept: create awareness and stimulate the buying impulse



| art. number | size lxd | | m ² | product | | qty. | | qty. | | qty. | ean code |
|-------------------|----------|-----|----------------|------------------------------------|-----|------|-----|------|-----|------|-----------------|
| 75 000 068 909 10 | 60 x 80 | 100 | 0.48 | corsica vertical forest 24cm set/3 | 150 | 8 | 425 | 8 | 623 | 8 | 8 711904 523664 |
| | | | | corsica vert forest large set/2 | 150 | 12 | 425 | 12 | 623 | 12 | |



CORSICA VERTICAL FOREST SHELF PRESENTATION

- live presentation of corsica vertical forest on the shelf, demo-products included



DEMONSTRATION STAND

| art. number | description | size lxd | h | m ² | | ean code |
|-------------------|--------------------------------------------|----------|-----|----------------|---|-----------------|
| 04 700 001 425 10 | corsica vertical forest shelf presentation | 30 x 30 | 100 | 0.3 | 1 | 8 711904 351441 |



CORSICA FLOWER BRIDGE 30CM DISPLAY

- ideal presentation to boost your seasonal sales



| art. number | size lxd | | m ² | product | | qty. | | qty. | | qty. | ean code |
|-------------------|----------|-----|----------------|----------------------------|-----|------|-----|------|-----|------|-----------------|
| 74 000 042 908 10 | 60 x 80 | 100 | 0.48 | corsica flower bridge 30cm | 150 | 33 | 425 | 33 | 623 | 22 | 8 711904 523671 |



CORSICA EASY HANGER DISPLAY

- proven sales succes, a musthave for your shopfloor



| art. number | size lxd | | m ² | product | | qty. | | qty. | | qty. | ean code |
|-------------------|----------|-----|----------------|----------------------------|-----|------|-----|------|-----|------|----------------------|
| 75 000 061 905 10 | 60 x 80 | 100 | 0.48 | corsica easy hanger single | 150 | 13 | 425 | 13 | 623 | 13 | 8 711904 1523688 |
| | | | | corsica easy hanger trio | 150 | 8 | 425 | 8 | 623 | 8 | |



INSPIRATIONAL BALCONY HEADER

- inspire your shopper, ideal presentation to attract shopper's attention and demonstrate pot-plant combinations



DEMONSTRATION STAND

| art. number | description | size lxd | h | m ² | | ean code |
|-------------------|------------------------------------------|-----------|----|----------------|---|---------------------|
| 19 100 033 724 50 | inspirational balcony header metal 200cm | 187 x 102 | 79 | 1.9 | 1 | 8 711904 509347 |



BALCONY SHELF PRESENTATION

- live presentation of corsica balcony products possible



DEMONSTRATION STAND

| art. number | description | size lxd | h | m ² | | ean code |
|-------------------|----------------------------|----------|-----|----------------|---|---------------------|
| 74 000 017 425 30 | balcony shelf presentation | 200 x 71 | 190 | 1.42 | 1 | 8 711904 217242 |



PLANT TABLE BALCONY PRESENTATION

- inspire your shopper with pot-plant combinations on stand



DEMONSTRATION STAND

| art. number | description | size lxd | h | m ² | | ean code |
|-------------------|----------------------------------|----------|----|----------------|---|-----------------|
| 19 100 012 150 50 | plant table balcony presentation | 100 x 47 | 62 | 0.42 | 1 | 8 711904 266974 |

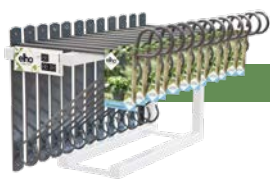

UNIVERSAL WALL HOOKS & BRACKETS SHELF PRESENTATION

- easy cross selling guaranteed - order products separately



1 SUPPORT STAND (EMPTY)

| art. number | description | size lxd | h | m ² | | ean code |
|-------------------|----------------------------------------------------|----------|----|----------------|---|-----------------|
| 11 000 007 724 50 | universal wall hooks & brackets shelf presentation | 20 x 60 | 25 | 0.12 | 1 | 8 711904 158101 |

2 PRODUCTS (CONTENT FOR STAND)

| art. number | product | | qty. | ean code |
|-------------------|-------------------------|-----|------|-----------------|
| 11 000 010 916 11 | wall hook elegance 30cm | 425 | 12 | 8 711904 264512 |





BARCELONA

The perfect balcony troughs turn every balcony into a green oasis. The clever hanging system makes the barcelona collection an all time favourite. Made out of recycled plastics.



NICE THINGS TO KNOW ABOUT THE FAMILY

-  MAXIMUM RAILING WIDTH 6CM
-  SAUCER SUPPORTS PLANT
-  MADE OUT OF RECYCLED PLASTICS
-  LIGHT WEIGHT
-  LONG-LASTING COLOUR
-  FROST PROOF



trough



trough saucer



wall bracket



balcony bracket



balcony support



trough all-in-1



xl



xl saucer



xl all-in-1



colours

| | | |
|-----|-----|-----|
| 150 | 270 | 360 |
| 410 | 425 | 623 |



barcelona COLLECTION



BARCELONA TROUGH

size = L x D, height = H



MADE OUT OF RECYCLED PLASTICS



OVERFLOW PIPE

| description | | | Ltr | Kg | | | additional information |
|-----------------------|--|------|-----|------|---|-----|------------------------|
| barcelona trough 40cm | | 16.0 | 8.0 | 0.32 | 5 | 540 | mix with saucer |

| | art. number | | ean code | | art. number | | ean code | | art. number | | ean code |
|-----|-------------------|---|----------|-----|-------------------|---|----------|-----|-------------------|---|----------|
| 150 | 78 419 140 150 00 | 5 | | 410 | 78 419 140 410 00 | 5 | | 425 | 78 419 140 425 00 | 5 | |
| 270 | 78 419 140 270 00 | 5 | | | | | | | | | |

| description | | | Ltr | Kg | | | additional information | |
|-----------------------|--|-------------|------|------|------|----|------------------------|-----------------|
| barcelona trough 50cm | | 49.8 x 19.0 | 16.0 | 10.0 | 0.41 | 10 | 560 | mix with saucer |

| | art. number | | ean code | | art. number | | ean code | | art. number | | ean code |
|-----|-------------------|----|----------|-----|-------------------|----|----------|-----|-------------------|----|----------|
| 150 | 78 419 150 150 00 | 10 | | 360 | 78 419 150 360 00 | 10 | | 425 | 78 419 150 425 00 | 10 | |
| 270 | 78 419 150 270 00 | 10 | | 410 | 78 419 150 410 00 | 10 | | 623 | 78 419 150 623 00 | 10 | |

| description | | | Ltr | Kg | | | additional information | |
|-----------------------|--|-------------|------|------|------|----|------------------------|-----------------|
| barcelona trough 70cm | | 69.8 x 19.0 | 16.0 | 14.0 | 0.59 | 10 | 420 | mix with saucer |

| | art. number | | ean code | | art. number | | ean code | | art. number | | ean code |
|-----|-------------------|----|----------|-----|-------------------|----|----------|-----|-------------------|----|----------|
| 150 | 78 419 170 150 00 | 10 | | 410 | 78 419 170 410 00 | 10 | | 425 | 78 419 170 425 00 | 10 | |
| 270 | 78 419 170 270 00 | 10 | | | | | | | | | |

| description | | | Ltr | Kg | | | additional information | |
|-----------------------|--|-------------|------|------|------|---|------------------------|-----------------|
| barcelona trough 90cm | | 89.8 x 19.0 | 16.0 | 18.0 | 0.72 | 5 | 240 | mix with saucer |

| | art. number | | ean code | | art. number | | ean code | | art. number | | ean code |
|-----|-------------------|---|----------|-----|-------------------|---|----------|-----|-------------------|---|----------|
| 150 | 78 419 190 150 00 | 5 | | 410 | 78 419 190 410 00 | 5 | | 425 | 78 419 190 425 00 | 5 | |
| 270 | 78 419 190 270 00 | 5 | | | | | | | | | |



BARCELONA TROUGH SAUCER

size = L x D, height = H



MADE OUT OF RECYCLED PLASTICS



SAUCER SUPPORTS PLANT

| description | | | | | | | additional information |
|------------------------------|--|-------------|-----|---|------|----|------------------------|
| barcelona trough saucer 40cm | | 34.6 x 16.0 | 2.8 | - | 0.11 | 10 | 1320 |

| | art. number | | ean code | | art. number | | ean code | | art. number | | ean code |
|-----|-------------------|----|-----------------|-----|-------------------|----|-----------------|-----|-------------------|----|-----------------|
| 150 | 79 103 035 150 00 | 10 | | 410 | 79 103 035 410 00 | 10 | | 425 | 79 103 035 425 00 | 10 | |
| | | | 8 711904 157425 | | | | 8 711904 157517 | | | | 8 711904 157548 |
| 270 | 79 103 035 270 00 | 10 | | | | | | | | | |
| | | | 8 711904 157456 | | | | | | | | |

| description | | | | | | | additional information |
|------------------------------|--|-------------|-----|---|------|----|------------------------|
| barcelona trough saucer 50cm | | 45.0 x 16.0 | 2.8 | - | 0.14 | 10 | 1160 |

| | art. number | | ean code | | art. number | | ean code | | art. number | | ean code |
|-----|-------------------|----|-----------------|-----|-------------------|----|-----------------|-----|-------------------|----|-----------------|
| 150 | 79 103 045 150 00 | 10 | | 360 | 79 103 045 360 00 | 10 | | 425 | 79 103 045 425 00 | 10 | |
| | | | 8 711904 154196 | | | | 8 711904 355814 | | | | 8 711904 121174 |
| 270 | 79 103 045 270 00 | 10 | | 410 | 79 103 045 410 00 | 10 | | 623 | 79 103 045 623 00 | 10 | |
| | | | 8 711904 121112 | | | | 8 711904 121143 | | | | 8 711904 238001 |

| description | | | | | | | additional information |
|------------------------------|--|-------------|-----|---|------|---|------------------------|
| barcelona trough saucer 70cm | | 65.0 x 16.0 | 2.8 | - | 0.20 | 5 | 705 |

| | art. number | | ean code | | art. number | | ean code | | art. number | | ean code |
|-----|-------------------|---|-----------------|-----|-------------------|---|-----------------|-----|-------------------|---|-----------------|
| 150 | 79 103 065 150 00 | 5 | | 410 | 79 103 065 410 00 | 5 | | 425 | 79 103 065 425 00 | 5 | |
| | | | 8 711904 154349 | | | | 8 711904 121150 | | | | 8 711904 121181 |
| 270 | 79 103 065 270 00 | 5 | | | | | | | | | |
| | | | 8 711904 121129 | | | | | | | | |

| description | | | | | | | additional information |
|------------------------------|--|-------------|-----|---|------|---|------------------------|
| barcelona trough saucer 90cm | | 85.3 x 16.0 | 2.8 | - | 0.28 | 5 | 520 |

| | art. number | | ean code | | art. number | | ean code | | art. number | | ean code |
|-----|-------------------|---|-----------------|-----|-------------------|---|-----------------|-----|-------------------|---|-----------------|
| 150 | 79 103 085 150 00 | 5 | | 410 | 79 103 085 410 00 | 5 | | 425 | 79 103 085 425 00 | 5 | |
| | | | 8 711904 154370 | | | | 8 711904 121167 | | | | 8 711904 121198 |
| 270 | 79 103 085 270 00 | 5 | | | | | | | | | |
| | | | 8 711904 121136 | | | | | | | | |

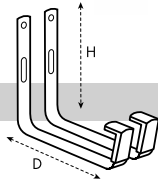

BARCELONA WALL BRACKET

size = L x D, height = H
for matching products, see p. 324-325



| description | | | | | | | additional information |
|------------------------|------------|------|---|------|----|------|------------------------|
| barcelona wall bracket | 18.4 x 1.6 | 14.8 | - | 0.34 | 10 | 1700 | supports max. 25kg |

| | art. number | | ean code |
|-----|-------------------|----|----------|
| 425 | 05 215 118 425 00 | 10 | |

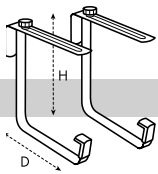

BARCELONA BALCONY BRACKET

size = L x D, height = H
for matching products, see p. 324-325



| description | | | | | | | additional information |
|---------------------------|------------|------|---|------|----|-----|------------------------|
| barcelona balcony bracket | 20.5 x 2.5 | 18.5 | - | 0.60 | 10 | 600 | supports max. 25kg |

| | art. number | | ean code |
|-----|-------------------|----|----------|
| 425 | 05 218 118 425 00 | 10 | |

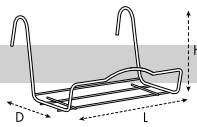

BALCONY SUPPORT

size = L x D, height = H
for matching products, see p. 324-325



| description | | | | | | | additional information |
|------------------------|-------------|------|---|------|----|-----|------------------------|
| balcony support medium | 38.5 x 31.5 | 22.3 | - | 0.67 | 12 | 144 | supports max. 20kg |

| | art. number | | ean code |
|-----|-------------------|----|----------|
| 425 | 12 701 202 425 00 | 12 | |

| description | | | | | | | additional information |
|-----------------------|-------------|------|---|------|----|----|------------------------|
| balcony support large | 58.5 x 31.3 | 22.5 | - | 0.81 | 12 | 96 | supports max. 25kg |

| | art. number | | ean code |
|-----|-------------------|----|----------|
| 425 | 12 701 203 425 00 | 12 | |



BARCELONA ALL-IN-1

size = L x D, height = H



| description | | | | | | | additional information |
|-------------------------|-------------|------|-----|------|---|-----|------------------------|
| barcelona all-in-1 50cm | 49.5 x 27.5 | 18.5 | 9.5 | 0.88 | 5 | 120 | supports max. 15kg |

| | art. number | | ean code | | art. number | | ean code | | art. number | | ean code |
|--|-------------------|---|----------|--|-------------------|---|----------|--|-------------------|---|----------|
| | 50 118 050 150 00 | 5 | | | 50 118 050 360 00 | 5 | | | 50 118 050 425 00 | 5 | |
| | 50 118 050 270 00 | 5 | | | 50 118 050 410 00 | 5 | | | 50 118 050 623 00 | 5 | |

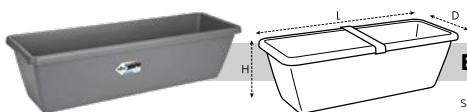

BARCELONA XL

size = L x D, height = H



| description | | | | | | | additional information |
|-------------------|-------------|------|------|------|---|-----|------------------------|
| barcelona xl 60cm | 59.0 x 24.5 | 20.5 | 20.0 | 0.71 | 5 | 210 | |

| | art. number | | ean code | | art. number | | ean code | | art. number | | ean code |
|--|-------------------|---|----------|--|-------------------|---|----------|--|-------------------|---|----------|
| | 05 020 060 150 00 | 5 | | | 05 020 060 410 00 | 5 | | | 05 020 060 425 00 | 5 | |

| description | | | | | | | additional information |
|-------------------|-------------|------|------|------|---|-----|------------------------|
| barcelona xl 80cm | 77.8 x 24.3 | 20.3 | 26.0 | 0.92 | 5 | 200 | |

| | art. number | | ean code | | art. number | | ean code | | art. number | | ean code |
|--|-------------------|---|----------|--|-------------------|---|----------|--|-------------------|---|----------|
| | 05 020 080 150 00 | 5 | | | 05 020 080 410 00 | 5 | | | 05 020 080 425 00 | 5 | |

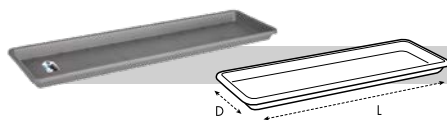

BARCELONA XL SAUCER

size = L x D, height = H

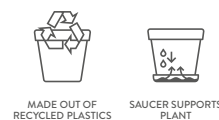

| description | | | | | | | additional information |
|--------------------------|-------------|-----|---|------|---|-----|------------------------|
| barcelona xl saucer 60cm | 54.5 x 21.0 | 3.6 | - | 0.24 | 5 | 635 | |

| | art. number | | ean code | | art. number | | ean code | | art. number | | ean code |
|-----|-------------------|---|----------|-----|-------------------|---|----------|-----|-------------------|---|----------|
| 150 | 05 003 152 150 00 | 5 | | 410 | 05 003 152 410 00 | 5 | | 425 | 05 003 152 425 00 | 5 | |

| description | | | | | | | additional information |
|--------------------------|-------------|-----|---|------|---|-----|------------------------|
| barcelona xl saucer 80cm | 72.5 x 20.3 | 3.5 | - | 0.34 | 5 | 465 | |

| | art. number | | ean code | | art. number | | ean code | | art. number | | ean code |
|-----|-------------------|---|----------|-----|-------------------|---|----------|-----|-------------------|---|----------|
| 150 | 05 003 171 150 00 | 5 | | 410 | 05 003 171 410 00 | 5 | | 425 | 05 003 171 425 00 | 5 | |

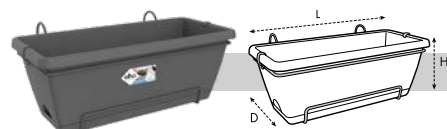

BARCELONA XL ALL-IN-1

size = L x D, height = H



| description | | | | | | | additional information |
|----------------------------|-------------|------|------|------|---|----|------------------------|
| barcelona xl all-in-1 55cm | 54.5 x 33.5 | 23.0 | 18.0 | 1.54 | 5 | 80 | supports max. 18kg |

| | art. number | | ean code | | art. number | | ean code | | art. number | | ean code |
|-----|-------------------|---|----------|-----|-------------------|---|----------|-----|-------------------|---|----------|
| 150 | 05 423 055 150 00 | 5 | | 410 | 05 423 055 410 00 | 5 | | 425 | 05 423 055 425 00 | 5 | |



BARCELONA XL

barcelona INSTORE PRESENTATIONS



BARCELONA BALCONY TROUGH STAND

• to inspire & activate your shopper, order a complete stand with content:

1 metal frame + 2 content = complete concept



1 METAL FRAME STAND (EMPTY)

| art. number | description | size lxd | h | m ² | | ean code |
|-------------------|------------------------------------------|----------|-----|----------------|---|-----------------|
| 19 100 050 150 50 | barcelona universal balcony trough stand | 87 x 110 | 198 | 0.96 | 1 | 8 711904 509187 |

2 PRODUCTS (CONTENT FOR STAND)

| art. number | product | | qty. | | qty. | | qty. | ean code |
|-------------------|----------------------------|-----|------|-----|------|-----|------|-----------------|
| 78 000 021 901 10 | barcelona trough 40 | 270 | 20 | 410 | 20 | 425 | 20 | 8 711904 509392 |
| | barcelona trough 50 | 270 | 20 | 410 | 20 | 425 | 20 | |
| | barcelona trough 70 | 270 | 10 | 410 | 10 | 425 | 10 | |
| | barcelona trough 90 | 270 | 10 | 410 | 10 | 425 | 10 | |
| | barcelona trough saucer 40 | 270 | 20 | 410 | 20 | 425 | 20 | |
| | barcelona trough saucer 50 | 270 | 20 | 410 | 20 | 425 | 20 | |
| | barcelona trough saucer 70 | 270 | 10 | 410 | 10 | 425 | 10 | |
| | barcelona trough saucer 90 | 270 | 10 | 410 | 10 | 425 | 10 | |
| | barcelona all-in-1 50cm | 270 | 5 | 410 | 5 | 425 | 5 | |

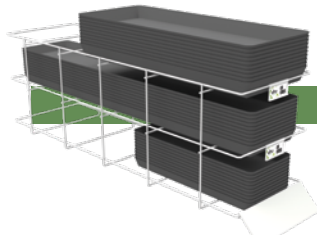

TROUGH SAUCERS IN-SHELF STAND

• ideal product placement in shelf - order products separately



SUPPORT STAND (EMPTY)

| art. number | description | size lxd | h | m ² | | ean code |
|-------------------|-----------------------------------------|----------|----|----------------|---|-----------------|
| 11 000 010 700 50 | universal trough saucers in-shelf stand | 26 x 85 | 32 | 0.22 | 1 | 8 711904 509170 |



INSPIRATIONAL BALCONY HEADER

- inspire your shopper, ideal presentation to attract shopper's attention and demonstrate pot-plant combinations



DEMONSTRATION STAND

| art. number | description | size lxd | h | m ² | | ean code |
|-------------------|------------------------------------------|-----------|----|----------------|---|-----------------|
| 19 100 033 724 50 | inspirational balcony header metal 200cm | 187 x 102 | 79 | 1.9 | 1 | 8 711904 509347 |



BARCELONA TROUGH ALL-IN-1 50CM DISPLAY

- #1 balcony display: a musthave for your shopfloor



| art. number | size lxd | | m ² | product | | qty. | ean code |
|-------------------|----------|-----|----------------|-------------------------|-----|------|-----------------|
| 50 000 184 150 10 | 60 x 80 | 100 | 0.48 | barcelona all-in-1 50cm | 150 | 36 | 8 711904 285500 |

| art. number | size lxd | | m ² | product | | qty. | ean code |
|-------------------|----------|-----|----------------|-------------------------|-----|------|-----------------|
| 50 000 184 360 10 | 60 x 80 | 100 | 0.48 | barcelona all-in-1 50cm | 360 | 36 | 8 711904 508630 |

| art. number | size lxd | | m ² | product | | qty. | ean code |
|-------------------|----------|-----|----------------|-------------------------|-----|------|-----------------|
| 50 000 184 410 10 | 60 x 80 | 100 | 0.48 | barcelona all-in-1 50cm | 410 | 36 | 8 711904 285531 |

| art. number | size lxd | | m ² | product | | qty. | ean code |
|-------------------|----------|-----|----------------|-------------------------|-----|------|-----------------|
| 50 000 184 425 10 | 60 x 80 | 100 | 0.48 | barcelona all-in-1 50cm | 425 | 36 | 8 711904 285548 |

| art. number | size lxd | | m ² | product | | qty. | | qty. | | qty. | ean code |
|-------------------|----------|-----|----------------|-------------------------|-----|------|-----|------|-----|------|-----------------|
| 50 000 191 901 10 | 60 x 80 | 100 | 0.48 | barcelona all-in-1 50cm | 150 | 12 | 410 | 12 | 425 | 12 | 8 711904 335670 |

| art. number | size lxd | | m ² | product | | qty. | | qty. | ean code |
|-------------------|----------|-----|----------------|-------------------------|-----|------|-----|------|-----------------|
| 50 000 191 902 10 | 60 x 80 | 100 | 0.48 | barcelona all-in-1 50cm | 150 | 18 | 425 | 18 | 8 711904 335687 |



BARCELONA XL ALL-IN-1 55CM DISPLAY

- ideal presentation to boost your seasonal sales



| art. number | size lxd | | m ² | product | | qty. | ean code |
|-------------------|----------|-----|----------------|----------------------------|-----|------|-----------------|
| 05 000 010 150 10 | 60 x 80 | 100 | 0.48 | barcelona xl all-in-1 55cm | 150 | 20 | 8 711904 320713 |

| art. number | size lxd | | m ² | product | | qty. | ean code |
|-------------------|----------|-----|----------------|----------------------------|-----|------|-----------------|
| 05 000 010 410 10 | 60 x 80 | 100 | 0.48 | barcelona xl all-in-1 55cm | 410 | 20 | 8 711904 320744 |

| art. number | size lxd | | m ² | product | | qty. | ean code |
|-------------------|----------|-----|----------------|----------------------------|-----|------|-----------------|
| 05 000 010 425 10 | 60 x 80 | 100 | 0.48 | barcelona xl all-in-1 55cm | 425 | 20 | 8 711904 320751 |



BALCONY SHELF PRESENTATION

- live presentation of barcelona trough's possible



DEMONSTRATION STAND

| art. number | description | size lxd | h | m ² | | ean code |
|-------------------|----------------------------|----------|-----|----------------|---|-----------------|
| 74 000 017 425 30 | balcony shelf presentation | 200 x 71 | 190 | 1.42 | 1 | 8 711904 217242 |



PLANT TABLE BALCONY PRESENTATION

- inspire your shopper with pot-plant combinations on stand



DEMONSTRATION STAND

| art. number | description | size lxd | h | m ² | | ean code |
|-------------------|----------------------------------|----------|----|----------------|---|-----------------|
| 19 100 012 150 50 | plant table balcony presentation | 100 x 47 | 62 | 0.47 | 1 | 8 711904 266974 |

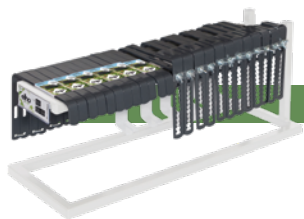



UNIVERSAL WALL HOOKS & BRACKETS SHELF PRESENTATION

- easy cross selling guaranteed - order products separately



SUPPORT STAND (EMPTY)

| art. number | description | size lxd | h | m ² |  | ean code |
|-------------------|----------------------------------------------------|----------|----|----------------|-------------------------------------------------------------------------------------|--------------------------------------------------------------------------------------------------------|
| 11 000 007 724 50 | universal wall hooks & brackets shelf presentation | 20 x 60 | 25 | 0.12 | 1 |  8 711904 158101 |



ALGARVE

A real classic collection with a Mediterranean look due to the unique floral pattern. The matching saucers, wheels and light weight quality make these planters easy to use and move. Made out of recycled plastics.



NICE THINGS TO KNOW ABOUT THE FAMILY



HOLES IN BOTTOM



SAUCER SUPPORTS PLANT



EASY TO MOVE



MADE OUT OF RECYCLED PLASTICS



LIGHT WEIGHT



LONG-LASTING COLOUR



FROST PROOF



cilindro



terrace wheels

DID YOU KNOW?

The bottom of the algarve pots is slightly elevated which makes it perfect to combine with growpots and stimulates plant growth.

colours

270

425



algarve COLLECTION

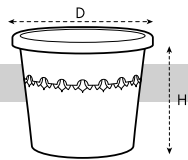

ALGARVE CILINDRO

size = L x D, height = H
for matching saucers, see p. 326-327



| description | | | | | | | additional information |
|-----------------------|------|------|-----|------|----|------|------------------------|
| algarve cilindro 21cm | 21.0 | 17.8 | 3.8 | 0.16 | 10 | 1620 | Ø21 |

| | art. number | | ean code | | art. number | | ean code |
|--|-------------------|----|-----------------|--|-------------------|----|-----------------|
| | 01 017 021 270 00 | 10 | 8 711904 052416 | | 01 017 021 425 00 | 10 | 8 711904 124700 |

| description | | | | | | | additional information |
|-----------------------|------|------|-----|------|----|------|------------------------|
| algarve cilindro 25cm | 24.5 | 20.8 | 6.0 | 0.23 | 10 | 1260 | Ø25 |

| | art. number | | ean code | | art. number | | ean code |
|--|-------------------|----|-----------------|--|-------------------|----|-----------------|
| | 01 020 025 270 00 | 10 | 8 711904 052423 | | 01 020 025 425 00 | 10 | 8 711904 117740 |

| description | | | | | | | additional information |
|-----------------------|------|------|------|------|----|-----|------------------------|
| algarve cilindro 30cm | 29.2 | 24.6 | 10.5 | 0.41 | 10 | 560 | Ø30 |

| | art. number | | ean code | | art. number | | ean code |
|--|-------------------|----|-----------------|--|-------------------|----|-----------------|
| | 01 025 030 270 00 | 10 | 8 711904 052447 | | 01 025 030 425 00 | 10 | 8 711904 106096 |

| description | | | | | | | additional information |
|-----------------------|------|------|------|------|----|-----|------------------------|
| algarve cilindro 35cm | 34.5 | 29.0 | 18.0 | 0.58 | 10 | 420 | Ø35 |

| | art. number | | ean code | | art. number | | ean code |
|--|-------------------|----|-----------------|--|-------------------|----|-----------------|
| | 01 029 035 270 00 | 10 | 8 711904 052461 | | 01 029 035 425 00 | 10 | 8 711904 117771 |

| description | | | | | | | additional information |
|------------------------------|------|------|------|------|----|-----|------------------------|
| algarve cilindro wheels 40cm | 39.5 | 34.2 | 27.0 | 0.95 | 10 | 360 | |

| | art. number | | ean code | | art. number | | ean code |
|--|------------------|----|-----------------|--|------------------|----|-----------------|
| | 01134 039 270 00 | 10 | 8 711904 250393 | | 01134 039 425 00 | 10 | 8 711904 250454 |

| description | | | | | | | additional information |
|------------------------------|------|------|------|------|---|-----|------------------------|
| algarve cilindro wheels 48cm | 47.5 | 41.0 | 47.0 | 1.49 | 5 | 135 | |

| | art. number | | ean code | | art. number | | ean code |
|--|------------------|---|-----------------|--|------------------|---|-----------------|
| | 01140 048 270 00 | 5 | 8 711904 250485 | | 01140 048 425 00 | 5 | 8 711904 250546 |

| description | | | | | | | additional information |
|------------------------------|------|------|------|------|---|----|------------------------|
| algarve cilindro wheels 58cm | 57.5 | 49.0 | 80.0 | 2.57 | 5 | 80 | |

| | art. number | | ean code | | art. number | | ean code |
|--|------------------|---|-----------------|--|------------------|---|-----------------|
| | 01148 058 270 00 | 5 | 8 711904 250577 | | 01148 058 425 00 | 5 | 8 711904 250638 |



ALGARVE TERRACE WHEELS

size = L x D, height = H



| description | | | | | | | additional information |
|-----------------------------|-------------|------|------|------|---|-----|------------------------|
| algarve terrace wheels 80cm | 77.5 x 38.5 | 33.2 | 60.0 | 2.29 | 3 | 108 | |

| | art. number | | ean code | | art. number | | ean code |
|--|------------------|---|-----------------|--|------------------|---|-----------------|
| | 01233 278 270 00 | 3 | 8 711904 302627 | | 01233 278 425 00 | 3 | 8 711904 302665 |



UNIVERSAL SAUCERS

Always keep your plants healthy with the saucer collection.
Suits every type of pot, such as ceramics, terracotta or synthetic.
Easy plant care solution for conscious consumers.

NICE THINGS TO KNOW ABOUT THE FAMILY



SAUCER SUPPORTS PLANT

MADE OUT OF RECYCLED PLASTICS

LIGHT WEIGHT

LONG-LASTING COLOUR

FROST PROOF



saucer round



saucer square



plant taxi



uni-saucer round



AVAILABLE IN SIZES

13, 15, 17, 19, 21, 25,
27, 30, 35, 40, 48cm

colours

100

270

425

universal saucers COLLECTION

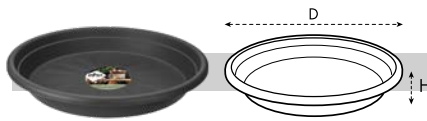

UNIVERSAL SAUCER ROUND

size = L x D, height = H
for matching products, see p. 326-327



| description | | | | | | | additional information |
|-----------------------------|------|-----|---|------|----|------|------------------------|
| universal saucer round 13cm | 13.0 | 1.9 | - | 0.02 | 10 | 9600 | |

| | art. number | | ean code | | art. number | | ean code |
|--|-------------------|----|----------|--|-------------------|----|----------|
| | 13 802 113 270 00 | 10 | | | 13 802 113 425 00 | 10 | |

| description | | | | | | | additional information |
|-----------------------------|------|-----|---|------|----|------|------------------------|
| universal saucer round 15cm | 15.0 | 2.4 | - | 0.03 | 10 | 6480 | |

| | art. number | | ean code | | art. number | | ean code |
|--|-------------------|----|----------|--|-------------------|----|----------|
| | 13 802 115 270 00 | 10 | | | 13 802 115 425 00 | 10 | |

| description | | | | | | | additional information |
|-----------------------------|------|-----|---|------|----|------|------------------------|
| universal saucer round 17cm | 17.0 | 2.6 | - | 0.04 | 10 | 4060 | |

| | art. number | | ean code | | art. number | | ean code |
|--|-------------------|----|----------|--|-------------------|----|----------|
| | 13 803 117 270 00 | 10 | | | 13 803 117 425 00 | 10 | |

| description | | | | | | | additional information |
|-----------------------------|------|-----|---|------|----|------|------------------------|
| universal saucer round 19cm | 19.0 | 2.8 | - | 0.05 | 10 | 3360 | |

| | art. number | | ean code | | art. number | | ean code |
|--|-------------------|----|----------|--|-------------------|----|----------|
| | 13 803 119 270 00 | 10 | | | 13 803 119 425 00 | 10 | |

| description | | | | | | | additional information |
|-----------------------------|------|-----|---|------|----|------|------------------------|
| universal saucer round 21cm | 21.0 | 3.1 | - | 0.07 | 10 | 2800 | |

| | art. number | | ean code | | art. number | | ean code |
|-----|-------------------|----|-----------------|-----|-------------------|----|-----------------|
| 270 | 13 803 121 270 00 | 10 | 8 711904 312077 | 425 | 13 803 121 425 00 | 10 | 8 711904 312138 |

| description | | | | | | | additional information |
|-----------------------------|------|-----|---|------|----|------|------------------------|
| universal saucer round 25cm | 25.0 | 3.8 | - | 0.10 | 10 | 1560 | |

| | art. number | | ean code | | art. number | | ean code |
|-----|-------------------|----|-----------------|-----|-------------------|----|-----------------|
| 270 | 13 804 125 270 00 | 10 | 8 711904 312213 | 425 | 13 804 125 425 00 | 10 | 8 711904 312251 |

| description | | | | | | | additional information |
|-----------------------------|------|-----|---|------|----|------|------------------------|
| universal saucer round 27cm | 27.0 | 3.8 | - | 0.12 | 10 | 1430 | |

| | art. number | | ean code | | art. number | | ean code |
|-----|-------------------|----|-----------------|-----|-------------------|----|-----------------|
| 270 | 13 804 127 270 00 | 10 | 8 711904 312275 | 425 | 13 804 127 425 00 | 10 | 8 711904 312312 |

| description | | | | | | | additional information |
|-----------------------------|------|-----|---|------|----|-----|------------------------|
| universal saucer round 30cm | 30.0 | 4.5 | - | 0.15 | 10 | 960 | |

| | art. number | | ean code | | art. number | | ean code |
|-----|-------------------|----|-----------------|-----|-------------------|----|-----------------|
| 270 | 13 804 130 270 00 | 10 | 8 711904 312336 | 425 | 13 804 130 425 00 | 10 | 8 711904 312374 |

| description | | | | | | | additional information |
|-----------------------------|------|-----|---|------|----|-----|------------------------|
| universal saucer round 35cm | 35.0 | 5.2 | - | 0.20 | 10 | 660 | |

| | art. number | | ean code | | art. number | | ean code |
|-----|-------------------|----|-----------------|-----|-------------------|----|-----------------|
| 270 | 13 805 135 270 00 | 10 | 8 711904 312398 | 425 | 13 805 135 425 00 | 10 | 8 711904 312435 |



| description | | | | | | | additional information |
|-----------------------------|------|-----|---|------|----|-----|------------------------|
| universal saucer round 40cm | 40.0 | 5.8 | - | 0.28 | 10 | 400 | |

| | art. number | | ean code | | art. number | | ean code |
|-----|-------------------|----|-----------------|-----|-------------------|----|-----------------|
| 270 | 13 806 140 270 00 | 10 | 8 711904 312459 | 425 | 13 806 140 425 00 | 10 | 8 711904 312497 |

| description | | | | | | | additional information |
|-----------------------------|------|-----|---|------|---|-----|------------------------|
| universal saucer round 48cm | 47.6 | 7.0 | - | 0.46 | 5 | 200 | |

| | art. number | | ean code | | art. number | | ean code |
|-----|-------------------|---|-----------------|-----|-------------------|---|-----------------|
| 270 | 13 807 148 270 00 | 5 | 8 711904 312510 | 425 | 13 807 148 425 00 | 5 | 8 711904 312558 |



UNIVERSAL SAUCER SQUARE

size = L x D, height = H



| description | | | | | | | additional information |
|------------------------------|-------------|-----|---|------|----|------|------------------------|
| universal saucer square 20cm | 20.0 x 20.0 | 3.0 | - | 0.07 | 10 | 2590 | |

| | art. number | | ean code |
|-----|-------------------|----|-----------------|
| 425 | 59 803 020 425 00 | 10 | 8 711904 313654 |

| description | | | | | | | additional information |
|------------------------------|-------------|-----|---|------|----|------|------------------------|
| universal saucer square 25cm | 25.0 x 25.0 | 3.8 | - | 0.12 | 10 | 1740 | |

| | art. number | | ean code |
|-----|-------------------|----|-----------------|
| 425 | 59 804 025 425 00 | 10 | 8 711904 313715 |

| description | | | | | | | additional information |
|------------------------------|-------------|-----|---|------|----|-----|------------------------|
| universal saucer square 30cm | 29.5 x 29.5 | 4.6 | - | 0.20 | 10 | 900 | |

| | art. number | | ean code |
|-----|-------------------|----|-----------------|
| 425 | 59 804 030 425 00 | 10 | 8 711904 313777 |

| description | | | | | | | additional information |
|------------------------------|-------------|-----|---|------|----|-----|------------------------|
| universal saucer square 35cm | 35.0 x 35.0 | 5.2 | - | 0.29 | 10 | 600 | |

| | art. number | | ean code |
|-----|-------------------|----|-----------------|
| 425 | 59 805 035 425 00 | 10 | 8 711904 313838 |



UNIVERSAL PLANTTAXI

size = L x D, height = H
for matching products, see p. 326-327



| description | | | | | | | additional information |
|--------------------------|------|-----|---|------|---|-----|------------------------|
| universal planttaxi 30cm | 28.5 | 6.5 | - | 0.34 | 5 | 180 | supports max. 60kg |

| | art. number | | ean code |
|-----|-------------------|---|-----------------|
| 270 | 64 405 429 270 00 | 5 | 8 711904 313852 |

| | art. number | | ean code |
|-----|-------------------|---|-----------------|
| 425 | 64 405 429 425 00 | 5 | 8 711904 313890 |

| description | | | | | | | additional information |
|--------------------------|------|-----|---|------|---|-----|------------------------|
| universal planttaxi 35cm | 33.7 | 6.5 | - | 0.50 | 5 | 120 | supports max. 60kg |

| | art. number | | ean code |
|-----|-------------------|---|-----------------|
| 270 | 64 405 434 270 00 | 5 | 8 711904 313913 |

| | art. number | | ean code |
|-----|-------------------|---|-----------------|
| 425 | 64 405 434 425 00 | 5 | 8 711904 313951 |

| description | | | | | | | additional information |
|--------------------------|------|-----|---|------|---|-----|------------------------|
| universal planttaxi 40cm | 38.2 | 6.5 | - | 0.65 | 5 | 100 | supports max. 60kg |

| | art. number | | ean code |
|-----|-------------------|---|-----------------|
| 270 | 64 405 439 270 00 | 5 | 8 711904 313975 |

| | art. number | | ean code |
|-----|-------------------|---|-----------------|
| 425 | 64 405 439 425 00 | 5 | 8 711904 314019 |

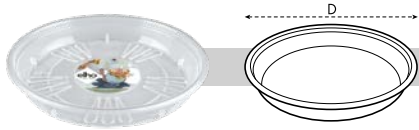

UNI-SAUCCER ROUND

size = L x D, height = H



| description | | | | | | | additional information |
|-----------------------|------|-----|---|------|----|------|------------------------|
| uni-saucer round 14cm | 14.0 | 2.2 | - | 0.02 | 10 | 5850 | |

| | art. number | | ean code |
|-----|-------------------|----|-----------------|
| 100 | 60 002 014 100 00 | 10 | 8 711904 228606 |

| description | | | | | | | additional information |
|-----------------------|------|-----|---|------|----|------|------------------------|
| uni-saucer round 16cm | 15.8 | 2.4 | - | 0.03 | 10 | 3850 | |

| | art. number | | ean code |
|-----|-------------------|----|-----------------|
| 100 | 60 002 016 100 00 | 10 | 8 711904 228637 |

| description | | | | | | | additional information |
|-----------------------|------|-----|---|------|----|------|------------------------|
| uni-saucer round 18cm | 18.0 | 2.6 | - | 0.04 | 10 | 2970 | |



| | art. number | | ean code |
|-----|-------------------|----|-----------------|
| 100 | 60 002 018 100 00 | 10 | 8 711904 228668 |



| description | | | | | | | additional information |
|-----------------------|------|-----|---|------|----|------|------------------------|
| uni-saucer round 21cm | 20.8 | 3.0 | - | 0.05 | 10 | 2200 | |







| | art. number | | ean code |
|-----|-------------------|----|-----------------|
| 100 | 60 003 021 100 00 | 10 | 8 711904 228699 |



| description | | | | | | | additional information |
|-----------------------|------|-----|---|------|----|------|------------------------|
| uni-saucer round 25cm | 24.2 | 3.4 | - | 0.07 | 10 | 1400 | |







| | art. number | | ean code |
|-----|-------------------|----|-----------------|
| 100 | 60 003 025 100 00 | 10 | 8 711904 228729 |



| description |  |  |  |  |  |  | additional information |
|-----------------------|-----------------------------------------------------------------------------------|-----------------------------------------------------------------------------------|-----------------------------------------------------------------------------------|------------------------------------------------------------------------------------|-------------------------------------------------------------------------------------|-------------------------------------------------------------------------------------|------------------------|
| uni-saucer round 28cm | 27.8 | 3.9 | - | 0.10 | 10 | 880 | |







|  | art. number |  | ean code |
|-----------------------------------------------------------------------------------|-------------------|-----------------------------------------------------------------------------------|------------------------------------------------------------------------------------------------------|
| 100 | 60 003 028 100 00 | 10 |  8 711904 228750 |



| description |  |  |  |  |  |  | additional information |
|-----------------------|-----------------------------------------------------------------------------------|-----------------------------------------------------------------------------------|-----------------------------------------------------------------------------------|------------------------------------------------------------------------------------|-------------------------------------------------------------------------------------|-------------------------------------------------------------------------------------|------------------------|
| uni-saucer round 33cm | 32.0 | 4.2 | - | 0.15 | 10 | 720 | |

|  | art. number |  | ean code |
|-----------------------------------------------------------------------------------|-------------------|-----------------------------------------------------------------------------------|------------------------------------------------------------------------------------------------------|
| 100 | 60 004 033 100 00 | 10 |  8 711904 228781 |

| description |  |  |  |  |  |  | additional information |
|-----------------------|-----------------------------------------------------------------------------------|-----------------------------------------------------------------------------------|-----------------------------------------------------------------------------------|------------------------------------------------------------------------------------|-------------------------------------------------------------------------------------|-------------------------------------------------------------------------------------|------------------------|
| uni-saucer round 37cm | 36.5 | 4.4 | - | 0.19 | 5 | 450 | |

|  | art. number |  | ean code |
|-------------------------------------------------------------------------------------|-------------------|-------------------------------------------------------------------------------------|--------------------------------------------------------------------------------------------------------|
| 100 | 60 004 037 100 00 | 5 |  8 711904 228811 |

| description |  |  |  |  |  |  | additional information |
|-----------------------|-------------------------------------------------------------------------------------|-------------------------------------------------------------------------------------|-------------------------------------------------------------------------------------|--------------------------------------------------------------------------------------|---------------------------------------------------------------------------------------|---------------------------------------------------------------------------------------|------------------------|
| uni-saucer round 42cm | 41.5 | 4.8 | - | 0.33 | 5 | 320 | |

|  | art. number |  | ean code |
|-------------------------------------------------------------------------------------|-------------------|-------------------------------------------------------------------------------------|--------------------------------------------------------------------------------------------------------|
| 100 | 60 004 042 100 00 | 5 |  8 711904 228842 |

universal saucers INSTORE PRESENTATIONS



UNIVERSAL SAUCER STAND 1 SIDED

- to inspire & activate your shopper, order a complete stand with content:

1 metal frame + 2 content = complete concept



1 METAL FRAME STAND (EMPTY)

| art. number | description | size lxd | h | m ² | | ean code |
|-------------------|----------------------------|----------|-----|----------------|---|-----------------|
| 13 000 008 150 50 | saucer floor stand 1 sided | 118 x 70 | 218 | 0.83 | 1 | 8 711904 322431 |

2 PRODUCTS (CONTENT FOR STAND)

| art. number | product | | qty. | ean code |
|-------------------|------------------------------|-----|------|-----------------|
| 13 000 018 425 10 | universal saucer round 13cm | 425 | 40 | 8 711904 322465 |
| | universal saucer round 15cm | 425 | 70 | |
| | universal saucer round 17cm | 425 | 70 | |
| | universal saucer round 19cm | 425 | 90 | |
| | universal saucer round 21cm | 425 | 90 | |
| | universal saucer round 25cm | 425 | 80 | |
| | universal saucer round 27cm | 425 | 70 | |
| | universal saucer round 30cm | 425 | 70 | |
| | universal saucer round 35cm | 425 | 80 | |
| | universal saucer round 40cm | 425 | 20 | |
| | universal saucer round 48cm | 425 | 15 | |
| | universal saucer square 20cm | 425 | 30 | |
| | universal saucer square 25cm | 425 | 30 | |
| | universal saucer square 30cm | 425 | 20 | |
| | universal saucer square 35cm | 425 | 20 | |
| | universal planttaxi 30cm | 425 | 10 | |
| | universal planttaxi 35cm | 425 | 10 | |
| | universal planttaxi 40cm | 425 | 10 | |



UNIVERSAL SAUCER STAND 2 SIDED

• to inspire & activate your shopper, order a complete stand with content:

1 metal frame + 2 content = complete concept



1 METAL FRAME STAND (EMPTY)

| art. number | description | size lxd | h | m ² | | ean code |
|-------------------|----------------------------|----------|-----|----------------|---|------------------|
| 13 000 009 150 50 | saucer floor stand 2 sided | 118 x 70 | 204 | 0.83 | 1 | 8 711904 32236 1 |

2 PRODUCTS (CONTENT FOR STAND)

| art. number | product | | qty. | | qty. | ean code |
|------------------------------|------------------------------|-----|------|-----|------|-------------------|
| 13 000 019 902 10 | universal saucer round 13cm | 270 | 20 | 425 | 20 | 8 711904 322472 1 |
| | universal saucer round 15cm | 270 | 20 | 425 | 20 | |
| | universal saucer round 17cm | 270 | 20 | 425 | 20 | |
| | universal saucer round 19cm | 270 | 50 | 425 | 50 | |
| | universal saucer round 21cm | 270 | 60 | 425 | 40 | |
| | universal saucer round 25cm | 270 | 90 | 425 | 80 | |
| | universal saucer round 27cm | 270 | 80 | 425 | 80 | |
| | universal saucer round 30cm | 270 | 40 | 425 | 30 | |
| | universal saucer round 35cm | 270 | 40 | 425 | 30 | |
| | universal saucer round 40cm | 270 | 20 | 425 | 20 | |
| | universal saucer round 48cm | 270 | 10 | 425 | 10 | |
| | universal saucer square 20cm | | | 425 | 20 | |
| | universal saucer square 25cm | | | 425 | 20 | |
| | universal saucer square 30cm | | | 425 | 10 | |
| universal saucer square 35cm | | | 425 | 10 | | |



UNIVERSAL PLANT TAXI SHELF PRESENTATION

- must have presentation for product placement & easy cross-selling



| art. number | description | size lxd | h | m ² | | ean code |
|------------------|-----------------------------------------|----------|----|----------------|---|-----------------|
| 64 000 001724 30 | universal plant taxi shelf presentation | 10 x 36 | 30 | 0.04 | 1 | 8 711904 115012 |



SAUCER UNIVERSAL COMPACT SUPPORT STAND

- to order a complete stand:

1 metal frame + **2** 2 x content = complete concept, also possible to combine with uni-saucer or floor protector





1 METAL FRAME STAND (EMPTY)



| art. number | description | size lxd | h | m ² | | ean code |
|-------------------|---------------------------------|----------|-----|----------------|---|-----------------|
| 19 100 033 150 50 | universal compact support stand | 65 x 55 | 198 | 0.36 | 1 | 8 711904 337766 |

2 PRODUCTS (CONTENT FOR STAND)

| art. number | product | | qty. | ean code |
|-------------------|-----------------------------|-----|------|-----------------|
| 13 000 034 270 10 | universal saucer round 13cm | 270 | 40 | 8 711904 339579 |
| | universal saucer round 15cm | 270 | 40 | |
| | universal saucer round 17cm | 270 | 40 | |
| | universal saucer round 19cm | 270 | 40 | |
| | universal saucer round 21cm | 270 | 20 | |
| | universal saucer round 25cm | 270 | 20 | |
| | universal saucer round 27cm | 270 | 20 | |
| | universal saucer round 30cm | 270 | 20 | |
| | universal saucer round 35cm | 270 | 20 | |
| | universal saucer round 40cm | 270 | 20 | |
| | universal saucer round 48cm | 270 | 15 | |

| art. number | product |  | qty. | ean code |
|-------------------|-----------------------------|-------------------------------------------------------------------------------------|------|--------------------------------------------------------------------------------------------------------|
| 13 000 036 425 10 | universal saucer round 13cm | 425 | 40 |  8 711904 339593 |
| | universal saucer round 15cm | 425 | 40 | |
| | universal saucer round 17cm | 425 | 40 | |
| | universal saucer round 19cm | 425 | 40 | |
| | universal saucer round 21cm | 425 | 20 | |
| | universal saucer round 25cm | 425 | 20 | |
| | universal saucer round 27cm | 425 | 20 | |
| | universal saucer round 30cm | 425 | 20 | |
| | universal saucer round 35cm | 425 | 20 | |
| | universal saucer round 40cm | 425 | 20 | |
| | universal saucer round 48cm | 425 | 15 | |

CAN ALSO BE MATCHED WITH:

| art. number | description | can be found on page: |  | ean code |
|-------------------|---------------------------------|-----------------------|---------------------------------------------------------------------------------------|----------------------------------------------------------------------------------------------------------|
| 60 000 014 100 10 | uni-saucer advised quantity | 134 | 100 |  8 711904 339609 |
| 13 000 033 100 10 | floorprotector advised quantity | 296 | 100 |  8 711904 339562 |



UNI-Saucer UNIVERSAL COMPACT SUPPORT STAND

• to order a complete stand:

1 metal frame + 2 2 x content = complete concept, also possible to combine with saucer or floor protector



1 METAL FRAME STAND (EMPTY)

| art. number | description | size lxd | h | m ² | | ean code |
|-------------------|--------------------------------------------|----------|-----|----------------|---|-----------------|
| 19 100 033 150 50 | uni-saucer universal compact support stand | 65 x 55 | 198 | 0.36 | 1 | 8 711904 337766 |

2 PRODUCTS (CONTENT FOR STAND)

| art. number | product | | qty. | ean code |
|-------------------|-----------------------|-----|------|-----------------|
| 60 000 014 100 10 | uni-saucer round 14cm | 100 | 80 | 8 711904 339609 |
| | uni-saucer round 16cm | 100 | 40 | |
| | uni-saucer round 18cm | 100 | 40 | |
| | uni-saucer round 21cm | 100 | 40 | |
| | uni-saucer round 25cm | 100 | 20 | |
| | uni-saucer round 28cm | 100 | 20 | |
| | uni-saucer round 33cm | 100 | 40 | |
| | uni-saucer round 37cm | 100 | 20 | |
| | uni-saucer round 42cm | 100 | 20 | |

CAN ALSO BE MATCHED WITH:

| art. number | description | can be found on page: | | ean code |
|-------------------|-----------------------------------|-----------------------|-----|-----------------|
| 13 000 034 270 10 | universal saucer advised quantity | 132 | 270 | 8 711904 339579 |
| 13 000 036 425 10 | universal saucer advised quantity | 133 | 425 | 8 711904 339593 |
| 13 000 033 100 10 | floorprotector advised quantity | 296 | 100 | 8 711904 339562 |



UNIVERSAL SAUCER ROUND



GREEN BASICS BALCONY

Fun, affordable and sustainable. Natural colours, matching saucers and made out of 100% recycled plastic.



NICE THINGS TO KNOW ABOUT THE FAMILY



FITS EVERY BALCONY



MADE OUT OF RECYCLED PLASTICS



LIGHT WEIGHT



LONG-LASTING COLOUR



FROST PROOF



colours

235

360

397

425

433

752



green basics balcony COLLECTION

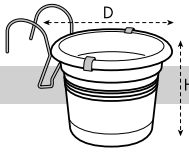

GREEN BASICS BALCONY POTHOLDER ALL-IN-1

size = L x D, height = H



| description | | | | | | | additional information |
|-----------------------------------------|-------------|------|-----|------|----|-----|------------------------|
| green basics balcony potholder all-in-1 | 26.0 x 19.5 | 18.5 | 2.4 | 0.25 | 12 | 432 | max. 5kg |

| | art. number | | ean code | | art. number | | ean code | | art. number | | ean code | |
|--|-------------|-------------------|----------|-----------------|-------------|-------------------|----------|-----------------|-------------|-------------------|----------|-----------------|
| | 235 | 67 914 919 235 00 | 12 | | 397 | 67 914 919 397 00 | 12 | | 752 | 67 914 919 752 00 | 12 | |
| | | | | 8 711904 345976 | | | | 8 711904 346034 | | | | 8 711904 344993 |
| | 360 | 67 914 919 360 00 | 12 | | 433 | 67 914 919 433 00 | 12 | | | | | |
| | | | | 8 711904 345051 | | | | 8 711904 344900 | | | | |

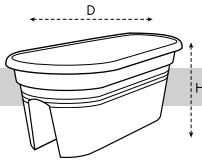

GREEN BASICS FLOWER BRIDGE

size = L x D, height = H



| description | | | | | | | additional information |
|---------------------------------|-------------|------|------|------|---|-----|------------------------|
| green basics flower bridge 55cm | 54.5 x 28.5 | 22.8 | 15.6 | 0.70 | 5 | 200 | |

| | art. number | | ean code | | art. number | | ean code | | art. number | | ean code | |
|--|-------------|-------------------|----------|-----------------|-------------|-------------------|----------|-----------------|-------------|-------------------|----------|-----------------|
| | 360 | 68 023 555 360 00 | 5 | | 433 | 68 023 555 433 00 | 5 | | 752 | 68 023 555 752 00 | 5 | |
| | | | | 8 711904 314118 | | | | 8 711904 265656 | | | | 8 711904 265687 |

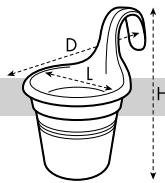

GREEN BASICS EASY HANGER SMALL

size = L x D, height = H



| description | | | | | | | additional information |
|--------------------------------|-------------|------|-----|------|---|-----|------------------------|
| green basics easy hanger small | 26.5 x 18.0 | 25.5 | 2.1 | 0.15 | 5 | 720 | |

| | art. number | | ean code | | art. number | | ean code | | art. number | | ean code | |
|--|-------------|-------------------|----------|-----------------|-------------|-------------------|----------|-----------------|-------------|-------------------|----------|-----------------|
| | 360 | 69 025 018 360 00 | 5 | | 433 | 69 025 018 433 00 | 5 | | 752 | 69 025 018 752 00 | 5 | |
| | | | | 8 711904 314774 | | | | 8 711904 247935 | | | | 8 711904 247966 |

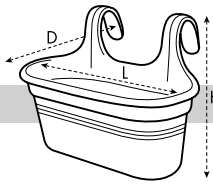

GREEN BASICS EASY HANGER LARGE

size = L x D, height = H



| description | | | | | | | additional information |
|--------------------------------|-------------|------|-----|------|---|-----|------------------------|
| green basics easy hanger large | 36.0 x 26.5 | 26.0 | 5.5 | 0.29 | 5 | 350 | |

| | art. number | | ean code | | art. number | | ean code | | art. number | | ean code |
|-----|-------------------|---|----------|-----|-------------------|---|----------|-----|-------------------|---|----------|
| 360 | 69 026 036 360 00 | 5 | | 433 | 69 026 036 433 00 | 5 | | 752 | 69 026 036 752 00 | 5 | |

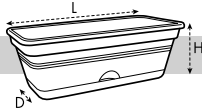

GREEN BASICS TROUGH MINI

size = L x D, height = H



| description | | | | | | | additional information |
|-------------------------------|-------------|------|-----|------|---|-----|------------------------|
| green basics trough mini 30cm | 29.6 x 11.5 | 11.0 | 1.2 | 0.15 | 5 | 490 | |

| | art. number | | ean code | | art. number | | ean code | | art. number | | ean code |
|-----|-------------------|---|----------|-----|-------------------|---|----------|-----|-------------------|---|----------|
| 360 | 68 211 629 360 00 | 5 | | 433 | 68 211 629 433 00 | 5 | | 752 | 68 211 629 752 00 | 5 | |

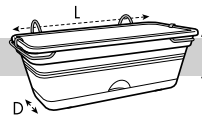

GREEN BASICS TROUGH MINI ALL-IN-1

size = L x D, height = H



| description | | | | | | | additional information |
|----------------------------------------|-------------|------|-----|------|---|-----|------------------------|
| green basics trough mini all-in-1 30cm | 29.5 x 19.5 | 15.5 | 2.5 | 0.28 | 5 | 490 | |

| | art. number | | ean code | | art. number | | ean code | | art. number | | ean code |
|-----|-------------------|---|----------|-----|-------------------|---|----------|-----|-------------------|---|----------|
| 360 | 69 516 030 360 00 | 5 | | 433 | 69 516 030 433 00 | 5 | | 752 | 69 516 030 752 00 | 5 | |



GREEN BASICS TROUGH

size = L x D, height = H



NEED TO DRILL HOLES FOR OUTDOOR USE



OVERFLOW PIPE

| description | | | | | | | additional information |
|--------------------------|-------------|------|-----|------|----|-----|------------------------|
| green basics trough 40cm | | | | | | | |
| | 39.3 x 16.5 | 14.0 | 6.0 | 0.27 | 10 | 700 | |

| | art. number | | ean code | | art. number | | ean code | | art. number | | ean code |
|--|-------------|-------------------|-----------------|--|-------------|-------------------|-----------------|--|-------------|-------------------|-----------------|
| | 360 | 35 114 839 360 00 | 10 | | 433 | 35 114 839 433 00 | 10 | | 752 | 35 114 839 752 00 | 10 |
| | | | 8 711904 298715 | | | | 8 711904 221713 | | | | 8 711904 221744 |

| description | | | | | | | additional information |
|--------------------------|-------------|------|-----|------|----|-----|------------------------|
| green basics trough 50cm | | | | | | | |
| | 48.8 x 16.5 | 14.0 | 7.7 | 0.31 | 10 | 450 | |

| | art. number | | ean code | | art. number | | ean code | | art. number | | ean code |
|--|-------------|-------------------|-----------------|--|-------------|-------------------|-----------------|--|-------------|-------------------|-----------------|
| | 360 | 35 114 849 360 00 | 10 | | 433 | 35 114 849 433 00 | 10 | | 752 | 35 114 849 752 00 | 10 |
| | | | 8 711904 298746 | | | | 8 711904 221867 | | | | 8 711904 221898 |

| description | | | | | | | additional information |
|--------------------------|-------------|------|-----|------|----|-----|------------------------|
| green basics trough 60cm | | | | | | | |
| | 58.3 x 16.5 | 14.0 | 9.5 | 0.35 | 10 | 450 | |

| | art. number | | ean code | | art. number | | ean code | | art. number | | ean code |
|--|-------------|-------------------|-----------------|--|-------------|-------------------|-----------------|--|-------------|-------------------|-----------------|
| | 360 | 35 114 859 360 00 | 10 | | 433 | 35 114 859 433 00 | 10 | | 752 | 35 114 859 752 00 | 10 |
| | | | 8 711904 298777 | | | | 8 711904 222017 | | | | 8 711904 222048 |

| description | | | | | | | additional information |
|--------------------------|-------------|------|------|------|----|-----|------------------------|
| green basics trough 80cm | | | | | | | |
| | 79.0 x 16.5 | 14.0 | 12.0 | 0.53 | 10 | 350 | |

| | art. number | | ean code | | art. number | | ean code | | art. number | | ean code |
|--|-------------|-------------------|-----------------|--|-------------|-------------------|-----------------|--|-------------|-------------------|-----------------|
| | 360 | 35 114 879 360 00 | 10 | | 433 | 35 114 879 433 00 | 10 | | 752 | 35 114 879 752 00 | 10 |
| | | | 8 711904 298807 | | | | 8 711904 222161 | | | | 8 711904 222192 |

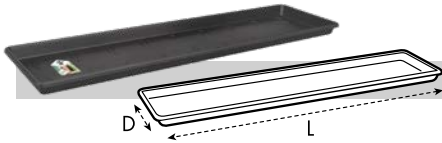

GREEN BASICS TROUGH SAUCER

size = L x D, height = H



SAUCER SUPPORTS PLANT

| description | | ◀▶ | ⬇️ | Ltr | Kg | 📦 | 🚚 | additional information |
|---------------------------------|--|-------------|-----|-----|------|----|------|------------------------|
| green basics trough saucer 40cm | | 37.5 x 15.0 | 2.5 | - | 0.08 | 10 | 2100 | |

| 📦 | art. number | 📦 | ean code | 📦 | art. number | 📦 | ean code | 📦 | art. number | 📦 | ean code |
|-----|-------------------|----|----------|-----|-------------------|----|----------|-----|-------------------|----|----------|
| 360 | 35 102 837 360 00 | 10 | | 433 | 35 102 837 433 00 | 10 | | 752 | 35 102 837 752 00 | 10 | |

| description | | ◀▶ | ⬇️ | Ltr | Kg | 📦 | 🚚 | additional information |
|---------------------------------|--|-------------|-----|-----|------|----|------|------------------------|
| green basics trough saucer 50cm | | 47.3 x 15.0 | 2.5 | - | 0.12 | 10 | 1560 | |

| 📦 | art. number | 📦 | ean code | 📦 | art. number | 📦 | ean code | 📦 | art. number | 📦 | ean code |
|-----|-------------------|----|----------|-----|-------------------|----|----------|-----|-------------------|----|----------|
| 360 | 35 102 847 360 00 | 10 | | 433 | 35 102 847 433 00 | 10 | | 752 | 35 102 847 752 00 | 10 | |

| description | | ◀▶ | ⬇️ | Ltr | Kg | 📦 | 🚚 | additional information |
|---------------------------------|--|-------------|-----|-----|------|----|------|------------------------|
| green basics trough saucer 60cm | | 56.8 x 15.0 | 2.5 | - | 0.14 | 10 | 1200 | |

| 📦 | art. number | 📦 | ean code | 📦 | art. number | 📦 | ean code | 📦 | art. number | 📦 | ean code |
|-----|-------------------|----|----------|-----|-------------------|----|----------|-----|-------------------|----|----------|
| 360 | 35 102 857 360 00 | 10 | | 433 | 35 102 857 433 00 | 10 | | 752 | 35 102 857 752 00 | 10 | |

| description | | ◀▶ | ⬇️ | Ltr | Kg | 📦 | 🚚 | additional information |
|---------------------------------|--|-------------|-----|-----|------|----|-----|------------------------|
| green basics trough saucer 80cm | | 77.5 x 15.0 | 2.5 | - | 0.20 | 10 | 910 | |

| 📦 | art. number | 📦 | ean code | 📦 | art. number | 📦 | ean code | 📦 | art. number | 📦 | ean code |
|-----|-------------------|----|----------|-----|-------------------|----|----------|-----|-------------------|----|----------|
| 360 | 35 102 877 360 00 | 10 | | 433 | 35 102 877 433 00 | 10 | | 752 | 35 102 877 752 00 | 10 | |

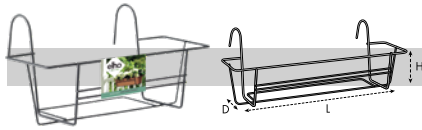

GREEN BASICS BALCONY RACKS METAL

size = L x D, height = H
for matching products, see p. 324-325



| description | | | | | | additional information | |
|--------------------------------|-------------|------|---|------|----|------------------------|--------------------|
| green basics balcony rack 40cm | 39.0 x 25.5 | 19.3 | - | 0.51 | 12 | 216 | supports max. 15kg |

| | art. number | | ean code |
|-----|-------------------|----|-----------------|
| 425 | 12 701 301 425 00 | 12 | 8 711904 135980 |

| description | | | | | | additional information | |
|--------------------------------|-------------|------|---|------|----|------------------------|--------------------|
| green basics balcony rack 50cm | 49.0 x 25.8 | 19.5 | - | 0.54 | 12 | 168 | supports max. 15kg |

| | art. number | | ean code |
|-----|-------------------|----|-----------------|
| 425 | 12 701 307 425 00 | 12 | 8 711904 271329 |

| description | | | | | | additional information | |
|--------------------------------|-------------|------|---|------|----|------------------------|--------------------|
| green basics balcony rack 60cm | 58.8 x 26.3 | 19.5 | - | 0.62 | 12 | 168 | supports max. 15kg |

| | art. number | | ean code |
|-----|-------------------|----|-----------------|
| 425 | 12 701 302 425 00 | 12 | 8 711904 136017 |

| description | | | | | | additional information | |
|--------------------------------|-------------|------|---|------|----|------------------------|--------------------|
| green basics balcony rack 80cm | 79.3 x 26.0 | 19.5 | - | 0.71 | 12 | 120 | supports max. 15kg |

| | art. number | | ean code |
|-----|-------------------|----|-----------------|
| 425 | 12 701 303 425 00 | 12 | 8 711904 136048 |

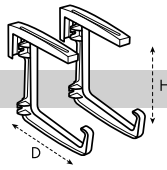

GREEN BASICS UNIVERSAL BRACKETS SYNTHETIC

size = L x D, height = H
for matching products, see p. 324-325



| description | | | | | | | additional information |
|-------------------------------------------|------------|------|---|------|----|-----|--------------------------------------|
| green basics universal brackets synthetic | 19.3 x 4.3 | 20.2 | - | 0.23 | 12 | 756 | supports max. 20kg - max. width 14cm |

| | art. number | | ean code |
|-----|-------------------|----|-----------------|
| 425 | 09 701 008 425 00 | 12 | 8 711904 249571 |

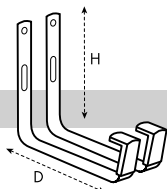

GREEN BASICS WALL BRACKET METAL

size = L x D, height = H
for matching products, see p. 324-325

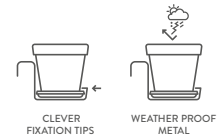

| description | | | | | | | additional information |
|---------------------------------|------------|------|---|------|----|------|--------------------------------------|
| green basics wall bracket metal | 15.6 x 1.6 | 17.0 | - | 0.22 | 10 | 2400 | supports max. 20kg - max. width 12cm |

| | art. number | | ean code |
|-----|-------------------|----|-----------------|
| 425 | 69 813 016 425 00 | 10 | 8 711904 249069 |

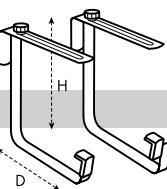

GREEN BASICS BALCONY BRACKET METAL

size = L x D, height = H
for matching products, see p. 324-325

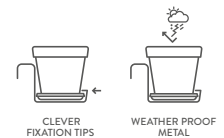

| description | | | | | | | additional information |
|------------------------------------|------------|------|---|------|----|-----|--------------------------------------|
| green basics balcony bracket metal | 18.0 x 4.5 | 16.5 | - | 0.47 | 10 | 600 | supports max. 20kg - max. width 12cm |

| | art. number | | ean code |
|-----|-------------------|----|-----------------|
| 425 | 69 816 020 425 00 | 10 | 8 711904 249090 |

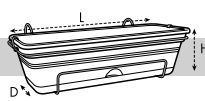

GREEN BASICS TROUGH ALL-IN-1

size = L x D, height = H



| description | | | | | | | | additional information |
|-----------------------------------|--|-------------|------|-----|------|---|-----|------------------------|
| green basics trough all-in-1 50cm | | 49.0 x 25.5 | 16.5 | 7.4 | 0.81 | 5 | 105 | |

| | art. number | | ean code | | art. number | | ean code | | art. number | | ean code |
|-----|-------------------|---|----------|-----|-------------------|---|----------|-----|-------------------|---|----------|
| 360 | 50 000 151 360 06 | 5 | | 433 | 50 000 151 433 06 | 5 | | 752 | 50 000 151 752 06 | 5 | |

| description | | | | | | | | additional information |
|-----------------------------------|--|-------------|------|------|------|---|----|------------------------|
| green basics trough all-in-1 70cm | | 68.5 x 26.0 | 16.5 | 11.0 | 1.05 | 5 | 60 | |

| | art. number | | ean code | | art. number | | ean code | | art. number | | ean code |
|-----|-------------------|---|----------|-----|-------------------|---|----------|-----|-------------------|---|----------|
| 360 | 69 517 069 360 00 | 5 | | 433 | 69 517 069 433 00 | 5 | | 752 | 69 517 069 752 00 | 5 | |

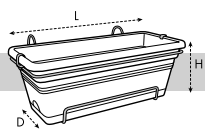

GREEN BASICS TROUGH XL ALL-IN-1

size = L x D, height = H



| description | | | | | | | | additional information |
|--------------------------------------|--|-------------|------|------|------|---|----|------------------------|
| green basics trough xl all-in-1 55cm | | 54.5 x 33.5 | 22.5 | 18.0 | 1.56 | 5 | 40 | |

| | art. number | | ean code | | art. number | | ean code | | art. number | | ean code |
|-----|-------------------|---|----------|-----|-------------------|---|----------|-----|-------------------|---|----------|
| 360 | 69 723 056 360 00 | 5 | | 433 | 69 723 056 433 00 | 5 | | 752 | 69 723 056 752 00 | 5 | |

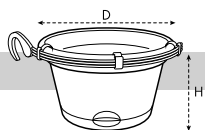

GREEN BASICS HANGING BASKET

size = L x D, height = H



| description | | | | | | | | additional information |
|----------------------------------|--|------|------|-----|------|---|-----|------------------------|
| green basics hanging basket 28cm | | 27.9 | 16.5 | 5.8 | 0.27 | 5 | 220 | |

| | art. number | | ean code | | art. number | | ean code | | art. number | | ean code |
|-----|-------------------|---|----------|-----|-------------------|---|----------|-----|-------------------|---|----------|
| 360 | 68 018 428 360 00 | 5 | | 433 | 68 018 428 433 00 | 5 | | 752 | 68 018 428 752 00 | 5 | |



GREEN BASICS TROUGH MINI



GREEN BASICS TERRACE

Fun, affordable and sustainable. Natural colours, matching saucers and made with 100% recycled plastic.

NICE THINGS TO KNOW ABOUT THE FAMILY



MADE OUT OF RECYCLED PLASTICS



LIGHT WEIGHT



LONG-LASTING COLOUR



FROST PROOF



cylinder



campana



bowl



saucer



garden xxl



garden xxl saucer



top planter



top planter high



colours

360

410

433

453

752



green basics terrace COLLECTION

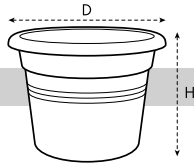

GREEN BASICS CILINDER

size = L x D, height = H



| description | | | | | | | additional information |
|----------------------------|------|------|-----|------|----|-----|------------------------|
| green basics cilinder 30cm | 29.5 | 22.4 | 9.0 | 0.28 | 10 | 560 | Ø25 |

| | art. number | | ean code | | art. number | | ean code | | art. number | | ean code | | | |
|--|-------------|-------------------|----------|--|-------------|-----|-------------------|----|-------------|--|----------|-------------------|----|--|
| | 360 | 87 322 529 360 00 | 10 | | | 433 | 87 322 529 433 00 | 10 | | | 752 | 87 322 529 752 00 | 10 | |

| description | | | | | | | additional information |
|----------------------------|------|------|------|------|----|-----|------------------------|
| green basics cilinder 35cm | 34.3 | 26.8 | 14.0 | 0.43 | 10 | 360 | Ø29 |

| | art. number | | ean code | | art. number | | ean code | | art. number | | ean code | | | |
|--|-------------|-------------------|----------|--|-------------|-----|-------------------|----|-------------|--|----------|-------------------|----|--|
| | 360 | 87 326 534 360 00 | 10 | | | 433 | 87 326 534 433 00 | 10 | | | 752 | 87 326 534 752 00 | 10 | |

| description | | | | | | | additional information |
|----------------------------|------|------|------|------|----|-----|------------------------|
| green basics cilinder 40cm | 38.8 | 30.0 | 21.0 | 0.62 | 10 | 360 | Ø34 |

| | art. number | | ean code | | art. number | | ean code | | art. number | | ean code | | | |
|--|-------------|-------------------|----------|--|-------------|-----|-------------------|----|-------------|--|----------|-------------------|----|--|
| | 360 | 87 330 539 360 00 | 10 | | | 433 | 87 330 539 433 00 | 10 | | | 752 | 87 330 539 752 00 | 10 | |

| description | | | | | | | additional information |
|----------------------------|------|------|------|------|---|-----|------------------------|
| green basics cilinder 45cm | 43.8 | 33.8 | 30.0 | 0.82 | 5 | 150 | Ø41 |

| | art. number | | ean code | | art. number | | ean code | | art. number | | ean code | | | |
|--|-------------|-------------------|----------|--|-------------|-----|-------------------|---|-------------|--|----------|-------------------|---|--|
| | 360 | 87 333 543 360 00 | 5 | | | 433 | 87 333 543 433 00 | 5 | | | 752 | 87 333 543 752 00 | 5 | |

| description | | | | | | | additional information |
|----------------------------|------|------|------|------|---|----|------------------------|
| green basics cilinder 55cm | 54.3 | 41.2 | 55.0 | 1.52 | 5 | 70 | Ø45 |

| | art. number | | ean code | | art. number | | ean code | | art. number | | ean code |
|-----|-------------------|---|----------|-----|-------------------|---|----------|-----|-------------------|---|----------|
| 360 | 87 341 554 360 00 | 5 | | 433 | 87 341 554 433 00 | 5 | | 752 | 87 341 554 752 00 | 5 | |

| description | | | | | | | additional information |
|----------------------------|------|------|------|------|---|----|------------------------|
| green basics cilinder 65cm | 64.0 | 48.5 | 92.0 | 2.35 | 3 | 21 | Ø53 |

| | art. number | | ean code | | art. number | | ean code | | art. number | | ean code |
|-----|-------------------|---|----------|-----|-------------------|---|----------|-----|-------------------|---|----------|
| 360 | 87 348 564 360 00 | 3 | | 433 | 87 348 564 433 00 | 3 | | 752 | 87 348 564 752 00 | 3 | |

| description | | | | | | | additional information |
|----------------------------|------|------|-------|------|---|----|------------------------|
| green basics cilinder 80cm | 77.5 | 60.0 | 168.0 | 4.22 | 1 | 18 | Ø65 |

| | art. number | | ean code | | art. number | | ean code | | art. number | | ean code |
|-----|-------------------|---|----------|-----|-------------------|---|----------|-----|-------------------|---|----------|
| 360 | 87 359 578 360 00 | 1 | | 433 | 87 359 578 433 00 | 1 | | 752 | 87 359 578 752 00 | 1 | |



GREEN BASICS CAMPANA

size = L x D, height = H



| description | | | | | | | additional information |
|---------------------------|------|------|-----|------|----|-----|------------------------|
| green basics campana 30cm | 29.3 | 22.4 | 7.6 | 0.27 | 10 | 640 | Ø22 |

| | art. number | | ean code | | art. number | | ean code |
|-----|-------------------|----|----------|-----|-------------------|----|----------|
| 433 | 86 223 330 433 00 | 10 | | 752 | 86 223 330 752 00 | 10 | |



| description | | | | | | | additional information |
|---------------------------|------|------|------|------|---|-----|------------------------|
| green basics campana 35cm | 34.0 | 27.0 | 12.0 | 0.36 | 5 | 420 | Ø22 |

| | art. number | | ean code | | art. number | | ean code |
|--|-------------------|---|----------|--|-------------------|---|----------|
| | 86 227 335 433 00 | 5 | | | 86 227 335 752 00 | 5 | |

| description | | | | | | | additional information |
|---------------------------|------|------|------|------|---|-----|------------------------|
| green basics campana 40cm | 38.5 | 30.8 | 18.0 | 0.55 | 5 | 360 | Ø25 |

| | art. number | | ean code | | art. number | | ean code |
|--|-------------------|---|----------|--|-------------------|---|----------|
| | 86 231 340 433 00 | 5 | | | 86 231 340 752 00 | 5 | |

| description | | | | | | | additional information |
|---------------------------|------|------|------|------|---|-----|------------------------|
| green basics campana 50cm | 48.2 | 38.4 | 34.4 | 0.95 | 5 | 150 | Ø34 |

| | art. number | | ean code | | art. number | | ean code |
|--|-------------------|---|----------|--|-------------------|---|----------|
| | 86 238 350 433 00 | 5 | | | 86 238 350 752 00 | 5 | |



GREEN BASICS BOWL

size = L x D, height = H



| description | | | | | | | additional information |
|------------------------|------|------|-----|------|----|------|------------------------|
| green basics bowl 27cm | 27.0 | 11.4 | 4.0 | 0.15 | 10 | 1200 | Ø25 |

| | art. number | | ean code | | art. number | | ean code | | art. number | | ean code |
|--|-------------------|----|----------|--|-------------------|----|----------|--|-------------------|----|----------|
| | 31 511 627 360 00 | 10 | | | 31 511 627 433 00 | 10 | | | 31 511 627 752 00 | 10 | |

| description | | | | | | | additional information |
|------------------------|------|------|-----|------|----|-----|------------------------|
| green basics bowl 33cm | 33.0 | 13.9 | 8.0 | 0.25 | 10 | 490 | Ø29 |

| | art. number | | ean code | | art. number | | ean code | | art. number | | ean code |
|--|-------------------|----|----------|--|-------------------|----|----------|--|-------------------|----|----------|
| | 31 514 633 360 00 | 10 | | | 31 514 633 433 00 | 10 | | | 31 514 633 752 00 | 10 | |

| description | ∅ | ↓ | Ltr | Kg | ☰ | ☰ | additional information |
|------------------------|------|------|------|------|---|-----|------------------------|
| green basics bowl 38cm | 38.0 | 15.9 | 12.0 | 0.35 | 5 | 420 | Ø34 |

| | art. number | ☰ | ean code | | art. number | ☰ | ean code | | art. number | ☰ | ean code | |
|--|-------------|-------------------|----------|--|-------------|-------------------|----------|--|-------------|-------------------|----------|--|
| | 360 | 31 516 638 360 00 | 5 | | 433 | 31 516 638 433 00 | 5 | | 752 | 31 516 638 752 00 | 5 | |



GREEN BASICS SAUCER

size = L x D, height = H
for matching products, see p. 326-327



| description | ∅ | ↓ | Ltr | Kg | ☰ | ☰ | additional information |
|--------------------------|------|-----|-----|------|----|-------|------------------------|
| green basics saucer 10cm | 10.0 | 1.5 | - | 0.01 | 10 | 14400 | |

| | art. number | ☰ | ean code | | art. number | ☰ | ean code | | art. number | ☰ | ean code | |
|--|-------------|-------------------|----------|--|-------------|-------------------|----------|--|-------------|-------------------|----------|--|
| | 360 | 69 902 210 360 00 | 10 | | 453 | 69 902 210 453 00 | 10 | | 752 | 69 902 210 752 00 | 10 | |
| | 433 | 69 902 210 433 00 | 10 | | | | | | | | | |

| description | ∅ | ↓ | Ltr | Kg | ☰ | ☰ | additional information |
|--------------------------|------|-----|-----|------|----|------|------------------------|
| green basics saucer 14cm | 13.5 | 1.8 | - | 0.02 | 20 | 9900 | |

| | art. number | ☰ | ean code | | art. number | ☰ | ean code | | art. number | ☰ | ean code | |
|--|-------------|-------------------|----------|--|-------------|-------------------|----------|--|-------------|-------------------|----------|--|
| | 360 | 69 902 214 360 00 | 20 | | 453 | 69 902 214 453 00 | 20 | | 752 | 69 902 214 752 00 | 20 | |
| | 433 | 69 902 214 433 00 | 20 | | | | | | | | | |

| description | ∅ | ↓ | Ltr | Kg | ☰ | ☰ | additional information |
|--------------------------|------|-----|-----|------|----|------|------------------------|
| green basics saucer 17cm | 17.0 | 2.3 | - | 0.04 | 20 | 5940 | |

| | art. number | ☰ | ean code | | art. number | ☰ | ean code | | art. number | ☰ | ean code | |
|--|-------------|-------------------|----------|--|-------------|-------------------|----------|--|-------------|-------------------|----------|--|
| | 360 | 69 902 217 360 00 | 20 | | 453 | 69 902 217 453 00 | 20 | | 752 | 69 902 217 752 00 | 20 | |
| | 433 | 69 902 217 433 00 | 20 | | | | | | | | | |



| description | | | | | | | additional information |
|--------------------------|------|-----|---|------|----|------|------------------------|
| green basics saucer 22cm | 21.5 | 3.2 | - | 0.05 | 15 | 3300 | |

| | art. number | | ean code | | art. number | | ean code | | art. number | | ean code |
|--|-------------------|----|----------|--|-------------------|----|----------|--|-------------------|----|----------|
| | 69 903 222 360 00 | 15 | | | 69 903 222 453 00 | 15 | | | 69 903 222 752 00 | 15 | |
| | 69 903 222 433 00 | 15 | | | | | | | | | |

| description | | | | | | | additional information |
|--------------------------|------|-----|---|------|----|------|------------------------|
| green basics saucer 25cm | 25.5 | 3.6 | - | 0.07 | 15 | 2115 | |

| | art. number | | ean code | | art. number | | ean code | | art. number | | ean code |
|--|-------------------|----|----------|--|-------------------|----|----------|--|-------------------|----|----------|
| | 69 904 225 360 00 | 15 | | | 69 904 225 453 00 | 15 | | | 69 904 225 752 00 | 15 | |
| | 69 904 225 433 00 | 15 | | | | | | | | | |

| description | | | | | | | additional information |
|--------------------------|------|-----|---|------|----|------|------------------------|
| green basics saucer 29cm | 29.3 | 4.2 | - | 0.12 | 10 | 1260 | |

| | art. number | | ean code | | art. number | | ean code | | art. number | | ean code |
|--|-------------------|----|----------|--|-------------------|----|----------|--|-------------------|----|----------|
| | 69 904 229 360 00 | 10 | | | 69 904 229 453 00 | 10 | | | 69 904 229 752 00 | 10 | |
| | 69 904 229 433 00 | 10 | | | | | | | | | |

| description | | | | | | | additional information |
|--------------------------|------|-----|---|------|----|-----|------------------------|
| green basics saucer 34cm | 33.5 | 4.8 | - | 0.18 | 10 | 840 | |

| | art. number | | ean code | | art. number | | ean code | | art. number | | ean code |
|--|-------------------|----|----------|--|-------------------|----|----------|--|-------------------|----|----------|
| | 69 905 234 360 00 | 10 | | | 69 905 234 453 00 | 10 | | | 69 905 234 752 00 | 10 | |
| | 69 905 234 433 00 | 10 | | | | | | | | | |

| description | | | | | | | additional information |
|--------------------------|------|-----|---|------|----|-----|------------------------|
| green basics saucer 41cm | 41.0 | 5.5 | - | 0.29 | 10 | 380 | |

| | art. number | | ean code | | art. number | | ean code | | art. number | | ean code |
|--|-------------------|----|----------|--|-------------------|----|----------|--|-------------------|----|----------|
| | 69 906 241 360 00 | 10 | | | 69 906 241 433 00 | 10 | | | 69 906 241 752 00 | 10 | |

| description | | | | | | | additional information |
|--------------------------|------|-----|---|------|---|-----|------------------------|
| green basics saucer 45cm | 45.2 | 5.5 | - | 0.40 | 5 | 270 | |

| | art. number | | ean code | | art. number | | ean code | | art. number | | ean code |
|--|-------------------|---|----------|--|-------------------|---|----------|--|-------------------|---|----------|
| | 69 906 245 360 00 | 5 | | | 69 906 245 433 00 | 5 | | | 69 906 245 752 00 | 5 | |

| description | | | | | | | additional information |
|--------------------------|------|-----|---|------|---|-----|------------------------|
| green basics saucer 53cm | 55.3 | 6.0 | - | 0.54 | 3 | 180 | |

| | art. number | | ean code | | art. number | | ean code | | art. number | | ean code |
|--|-------------------|---|----------|--|-------------------|---|----------|--|-------------------|---|----------|
| | 69 906 253 360 00 | 3 | | | 69 906 253 433 00 | 3 | | | 69 906 253 752 00 | 3 | |

| description | | | | | | | additional information |
|--------------------------|------|-----|---|------|---|-----|------------------------|
| green basics saucer 65cm | 65.0 | 6.9 | - | 1.17 | 3 | 105 | |

| | art. number | | ean code |
|--|-------------------|---|----------|
| | 69 907 265 433 00 | 3 | |

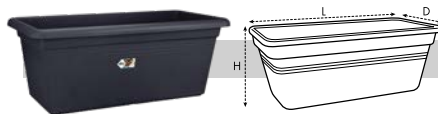

GREEN BASICS GARDEN XXL

size = L x D, height = H



| description | | | | | | | | additional information |
|------------------------------|--|-------------|------|------|------|---|-----|------------------------|
| green basics garden xxl 60cm | | 58.0 x 28.5 | 26.8 | 28.0 | 1.20 | 5 | 160 | includes stabiliser 1x |

| | art. number | | ean code | | art. number | | ean code | | art. number | | ean code |
|-----|-------------------|---|----------|-----|-------------------|---|----------|-----|-------------------|---|----------|
| 360 | 91 128 659 360 00 | 5 | | 433 | 91 128 659 433 00 | 5 | | 752 | 91 128 659 752 00 | 5 | |

| description | | | | | | | | additional information |
|------------------------------|--|-------------|------|------|------|---|-----|------------------------|
| green basics garden xxl 80cm | | 77.0 x 39.0 | 34.5 | 62.0 | 2.15 | 3 | 108 | includes stabiliser 1x |

| | art. number | | ean code | | art. number | | ean code | | art. number | | ean code |
|-----|-------------------|---|----------|-----|-------------------|---|----------|-----|-------------------|---|----------|
| 360 | 91 134 678 360 00 | 3 | | 433 | 91 134 678 433 00 | 3 | | 752 | 91 134 678 752 00 | 3 | |

| description | | | | | | | | additional information |
|-------------------------------|--|-------------|------|-------|------|---|----|------------------------|
| green basics garden xxl 100cm | | 96.0 x 44.5 | 39.5 | 100.0 | 3.14 | 3 | 30 | includes stabiliser 1x |

| | art. number | | ean code | | art. number | | ean code |
|-----|-------------------|---|----------|-----|-------------------|---|----------|
| 433 | 91 142 698 433 00 | 3 | | 752 | 91 142 698 752 00 | 3 | |

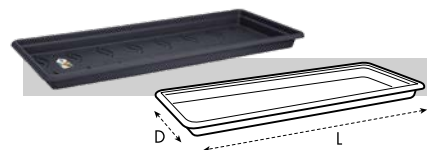

GREEN BASICS GARDEN XXL SAUCER

size = L x D, height = H



| description | | | | | | | | additional information |
|-------------------------------------|--|-------------|-----|---|------|---|-----|------------------------|
| green basics garden xxl saucer 60cm | | 54.5 x 25.5 | 4.8 | - | 0.35 | 5 | 400 | |

| | art. number | | ean code | | art. number | | ean code | | art. number | | ean code |
|-----|-------------------|---|----------|-----|-------------------|---|----------|-----|-------------------|---|----------|
| 360 | 91 205 755 360 00 | 5 | | 433 | 91 205 755 433 00 | 5 | | 752 | 91 205 755 752 00 | 5 | |

| description | | | | | | | additional information |
|-------------------------------------|-------------|-----|---|------|---|-----|------------------------|
| green basics garden xxl saucer 80cm | 72.2 x 32.2 | 5.7 | - | 0.63 | 3 | 243 | |

| | art. number | | ean code | | art. number | | ean code | | art. number | | ean code |
|--|-------------------|---|----------|--|-------------------|---|----------|--|-------------------|---|----------|
| | 91 206 773 360 00 | 3 | | | 91 206 773 433 00 | 3 | | | 91 206 773 752 00 | 3 | |

| description | | | | | | | additional information |
|--------------------------------------|-------------|-----|---|------|---|-----|------------------------|
| green basics garden xxl saucer 100cm | 89.5 x 37.0 | 6.0 | - | 0.88 | 3 | 168 | |

| | art. number | | ean code | | art. number | | ean code |
|--|-------------------|---|----------|--|-------------------|---|----------|
| | 91 207 797 433 00 | 3 | | | 91 207 797 752 00 | 3 | |

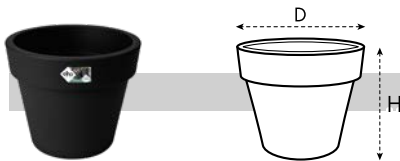

GREEN BASICS TOP PLANTER

size = L x D, height = H



NEED TO DRILL HOLES FOR OUTDOOR USE

| description | | | | | | | additional information |
|-------------------------------|------|------|-----|------|---|-----|------------------------|
| green basics top planter 23cm | 23.0 | 19.6 | 6.0 | 0.23 | 5 | 420 | |

| | art. number | | ean code | | art. number | | ean code | | art. number | | ean code |
|--|-------------------|---|----------|--|-------------------|---|----------|--|-------------------|---|----------|
| | 76 119 023 410 00 | 5 | | | 76 119 023 433 00 | 5 | | | 76 119 023 453 00 | 5 | |

| description | | | | | | | additional information |
|-------------------------------|------|------|------|------|---|-----|------------------------|
| green basics top planter 30cm | 29.5 | 25.2 | 10.0 | 0.41 | 5 | 240 | |

| | art. number | | ean code | | art. number | | ean code | | art. number | | ean code |
|--|-------------------|---|----------|--|-------------------|---|----------|--|-------------------|---|----------|
| | 76 125 030 410 00 | 5 | | | 76 125 030 433 00 | 5 | | | 76 125 030 453 00 | 5 | |



| description | | | | | | | additional information |
|-------------------------------|------|------|------|------|---|-----|------------------------|
| green basics top planter 40cm | 39.0 | 33.0 | 24.0 | 0.78 | 5 | 120 | |

| | art. number | | ean code | | art. number | | ean code | | art. number | | ean code |
|-----|-------------------|---|-----------------|-----|-------------------|---|-----------------|-----|-------------------|---|-----------------|
| 410 | 76 133 039 410 00 | 5 | 8 711904 315696 | 433 | 76 133 039 433 00 | 5 | 8 711904 267964 | 453 | 76 133 039 453 00 | 5 | 8 711904 315719 |

| description | | | | | | | additional information |
|-------------------------------|------|------|------|------|---|----|------------------------|
| green basics top planter 47cm | 47.0 | 40.0 | 42.0 | 1.25 | 5 | 45 | |

| | art. number | | ean code | | art. number | | ean code | | art. number | | ean code |
|-----|-------------------|---|-----------------|-----|-------------------|---|-----------------|-----|-------------------|---|-----------------|
| 410 | 76 140 047 410 00 | 5 | 8 711904 315733 | 433 | 76 140 047 433 00 | 5 | 8 711904 268084 | 453 | 76 140 047 453 00 | 5 | 8 711904 315757 |

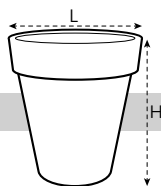

GREEN BASICS TOP PLANTER HIGH

size = L x D, height = H



NEED TO DRILL HOLES FOR OUTDOOR USE

| description | | | | | | | additional information |
|------------------------------------|------|------|------|------|---|-----|------------------------|
| green basics top planter high 35cm | 34.5 | 41.0 | 23.0 | 0.83 | 5 | 120 | |

| | art. number | | ean code | | art. number | | ean code | | art. number | | ean code |
|-----|-------------------|---|-----------------|-----|-------------------|---|-----------------|-----|-------------------|---|-----------------|
| 410 | 76 141 035 410 00 | 5 | 8 711904 315771 | 433 | 76 141 035 433 00 | 5 | 8 711904 272241 | 453 | 76 141 035 453 00 | 5 | 8 711904 315795 |



GREEN BASICS BOWL

green basics INSTORE PRESENTATIONS



GREEN BASICS BALCONY TROUGH STAND

• to inspire & activate your shopper, order a complete stand with content:

1 metal frame + 2 content = complete concept



1 METAL FRAME STAND (EMPTY)

| art. number | description | size lxd | h | m ² | | ean code |
|-------------------|---------------------------------------------|----------|-----|----------------|---|-----------------|
| 19 100 035 050 50 | green basics universal balcony trough stand | 87 x 110 | 198 | 0.96 | 1 | 8 711904 509194 |

2 PRODUCTS (CONTENT FOR STAND)

| art. number | product | | qty. | | qty. | | qty. | ean code |
|-------------------|-----------------------------------|-----|------|-----|------|-----|------|-----------------|
| 35 100 040 901 10 | green basics trough 40 | 360 | 20 | 433 | 20 | 752 | 20 | 8 711904 509385 |
| | green basics trough 50 | 360 | 20 | 433 | 20 | 752 | 20 | |
| | green basics trough 60 | 360 | 10 | 433 | 10 | 752 | 10 | |
| | green basics trough 80 | 360 | 10 | 433 | 10 | 752 | 10 | |
| | green basics trough saucer 40 | 360 | 20 | 433 | 20 | 752 | 20 | |
| | green basics trough saucer 50 | 360 | 20 | 433 | 20 | 752 | 20 | |
| | green basics trough saucer 60 | 360 | 10 | 433 | 10 | 752 | 10 | |
| | green basics trough saucer 80 | 360 | 10 | 433 | 10 | 752 | 10 | |
| | green basics trough all-in-1 50cm | 360 | 5 | 433 | 5 | 752 | 5 | |

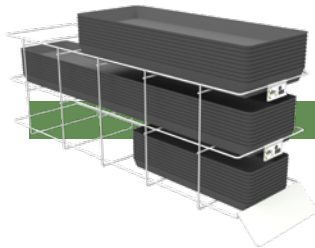

TROUGH SAUCERS IN-SHELF STAND

• ideal product placement in shelf - order products separately



DEMONSTRATION STAND

| art. number | description | size lxd | h | m ² | | ean code |
|-------------------|-----------------------------------------|----------|----|----------------|---|-----------------|
| 11 000 010 700 50 | universal trough saucers in-shelf stand | 26 x 85 | 32 | 0.22 | 1 | 8 711904 509170 |



GREEN BASICS BALCONY POTHOLDER ALL-IN-1 DISPLAY



- create awareness and stimulate the buying impulse

| art. number | size lxd | | m ² | product | | qty. | | qty. | | qty. | ean code |
|-------------------|----------|-----|----------------|-----------------------------------------|--|------|--|------|--|------|----------|
| 50 000 178 914 10 | 60 x 80 | 100 | 0.48 | green basics balcony potholder all-in-1 | | 35 | | 35 | | 42 | |

| art. number | size lxd | | m ² | product | | qty. | | qty. | | qty. | ean code |
|-------------------|----------|-----|----------------|-----------------------------------------|--|------|--|------|--|------|----------|
| 50 000 178 915 10 | 60 x 80 | 100 | 0.48 | green basics balcony potholder all-in-1 | | 28 | | 42 | | 42 | |



GREEN BASICS EASY HANGER COMBINATION DISPLAY



- ideal presentation to boost your seasonal sales

| art. number | size lxd | | m ² | product | | qty. | | qty. | | qty. | ean code |
|-------------------|----------|-----|----------------|--------------------------------|--|------|--|------|--|------|----------|
| 69 000 019 902 10 | 60 x 80 | 100 | 0.48 | green basics easy hanger small | | 15 | | 30 | | 15 | |
| | | | | green basics easy hanger large | | 15 | | 15 | | 15 | |



GREEN BASICS TROUGH & TROUGH SAUCER DISPLAY



- let's seduce your shopper, stimulate the buying impulse

| art. number | size lxd | | m ² | product | | qty. | | qty. | | qty. | ean code |
|-------------------|----------|-----|----------------|---------------------------------|--|------|--|------|--|------|----------|
| 35 000 080 901 10 | 60 x 80 | 100 | 0.48 | green basics trough 50cm | | 50 | | 50 | | 50 | |
| | | | | green basics trough saucer 50cm | | 40 | | 40 | | 40 | |

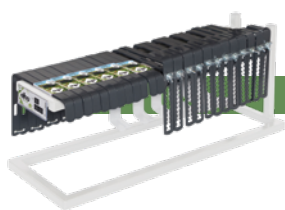

UNIVERSAL WALL HOOKS & BRACKETS SHELF PRESENTATION

- easy cross selling guarenteed - order products seperately



SUPPORT STAND (EMPTY)

| art. number | description | size lxd | h | m ² | | ean code |
|-------------------|----------------------------------------------------|----------|----|----------------|---|-----------------|
| 11 000 007 724 50 | universal wall hooks & brackets shelf presentation | 20 x 60 | 25 | 0.12 | 1 | 8 711904 158101 |



GREEN BASICS TROUGH ALL-IN-1 50CM DISPLAY

- proven sales succes, a musthave for your shopfloor



| art. number | size lxd | | m ² | product | | qty. | ean code |
|-------------------|----------|-----|----------------|-----------------------------------|-----|------|-----------------|
| 68 000 006 433 09 | 60 x 80 | 100 | 0.48 | green basics trough all-in-1 50cm | 433 | 48 | 8 711904 158750 |

| art. number | size lxd | | m ² | product | | qty. | | qty. | ean code |
|-------------------|----------|-----|----------------|-----------------------------------|-----|------|-----|------|-----------------|
| 68 000 063 901 10 | 60 x 80 | 100 | 0.48 | green basics trough all-in-1 50cm | 360 | 24 | 433 | 24 | 8 711904 484835 |

| art. number | size lxd | | m ² | product | | qty. | | qty. | | qty. | ean code |
|-------------------|----------|-----|----------------|-----------------------------------|-----|------|-----|------|-----|------|-----------------|
| 68 000 063 902 10 | 60 x 80 | 100 | 0.48 | green basics trough all-in-1 50cm | 360 | 16 | 433 | 16 | 752 | 16 | 8 711904 484910 |



GREEN BASICS TROUGH ALL-IN-1 70CM DISPLAY



- ideal presentation for best-selling product: sales success guaranteed

| art. number | size lxd | | m ² | product | | qty. | ean code |
|-------------------|----------|-----|----------------|-----------------------------------|-----|------|-----------------|
| 68 000 063 433 10 | 60 x 80 | 100 | 0.48 | green basics trough all-in-1 70cm | 433 | 34 | 8 711904 484941 |

| art. number | size lxd | | m ² | product | | qty. | | qty. | ean code |
|-------------------|----------|-----|----------------|-----------------------------------|-----|------|-----|------|-----------------|
| 68 000 063 903 10 | 60 x 80 | 100 | 0.48 | green basics trough all-in-1 70cm | 360 | 17 | 433 | 17 | 8 711904 484927 |

| art. number | size lxd | | m ² | product | | qty. | | qty. | | qty. | ean code |
|-------------------|----------|-----|----------------|-----------------------------------|-----|------|-----|------|-----|------|-----------------|
| 68 000 063 905 10 | 60 x 80 | 100 | 0.48 | green basics trough all-in-1 70cm | 360 | 11 | 433 | 12 | 752 | 11 | 8 711904 485252 |



GREEN BASICS TOP PLANTER ISLAND PRESENTATION



- let's seduce your shopper, stimulate the buying impulse

| art. number | size lxd | m ² | product | | qty. | | qty. | ean code |
|-------------------|----------|----------------|------------------------------------|-----|------|-----|------|-----------------|
| 76 000 006 905 10 | 120 x 80 | 0.96 | green basics top planter 30cm | 433 | 10 | 453 | 10 | 8 711904 318444 |
| | | | green basics top planter 40cm | 433 | 7 | 453 | 7 | |
| | | | green basics top planter high 35cm | 433 | 9 | 453 | 9 | |





care & grow

COLLECTION



GREEN BASICS GROW YOUR OWN

You can grow your own vegetables, fruit and herbs easily with the green basics grow your own collection. For every phase in the growing process there is the right product to use. With the new green basics growpots square all-in-1 and grow trays all-in-1 you have your own tiny grow garden. When you are thinking of grow your own, you are also thinking about watering. It's easy with our new green basics rainbarrel plus to collect rainwater for watering your plants.

NICE THINGS TO KNOW ABOUT THE FAMILY

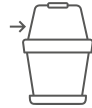

GROW HOUSE STIMULATES GROWTH



HOLES IN BOTTOM



MADE OUT OF RECYCLED PLASTICS



LIGHT WEIGHT



LONG-LASTING COLOUR



FROST PROOF



rainbarrel plus



rainbarrel diverter



rain catcher



stack & grow large



veggie wall



tomato pot



potato pot



growpot square all-in-1



grow tray all-in-1



grow kit all-in-1

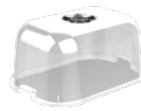

grow house



grow tray



grow tray saucer



grow house round



growpot starter set



growpot



growpot orchid



growpot orchid saucer



garden tray



plant label



scoop



grow house xxl



grow table xxl



colours

| | | | |
|-----|-----|-----|-----|
| 100 | 150 | 360 | 397 |
| 431 | 433 | 453 | 752 |



WATCH THE STACK & GROW PRODUCT VIDEO

INNOVATION

rainbarrel plus & diverter
growpot square all-in-1
grow tray all-in-1

grow your own COLLECTION

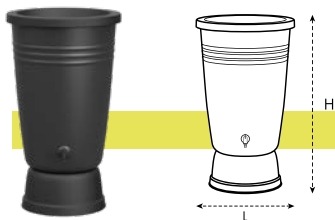

GREEN BASICS RAINBARREL PLUS

size = L x D, height = H

NEW



110 LITERS



200 LITERS



STAND INCLUDED



PLANTER INCLUDED



TAP INCLUDED

| description | | | | | | | additional information |
|-------------------------------------|------|-------|-------|------|---|---|------------------------|
| green basics rainbarrel plus 110ltr | 58.4 | 101.2 | 110.0 | 7.09 | 3 | 9 | |

| | art. number | | ean code |
|-----|-------------------|---|-----------------|
| 433 | 86 180 058 433 00 | 3 | 8 711904 523312 |

| description | | | | | | | additional information |
|-------------------------------------|------|-------|-------|-------|---|---|------------------------|
| green basics rainbarrel plus 200ltr | 70.5 | 121.7 | 200.0 | 10.87 | 2 | 6 | |

| | art. number | | ean code |
|-----|-------------------|---|-----------------|
| 433 | 86 110 170 433 00 | 2 | 8 711904 523329 |

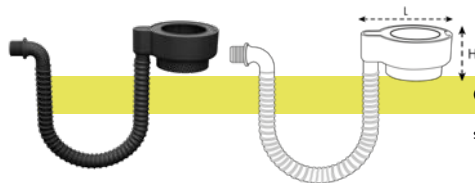

GREEN BASICS RAINBARREL DIVERTER

size = L x D, height = H

NEW



HOSE & CONNECTOR INCLUDED



FITS DRAINPIPE Ø70-80-100MM + SQUARE



EASY TO INSTALL

| description | | | | | | | additional information |
|----------------------------------|-------------|-----|---|------|---|-----|------------------------|
| green basics rainbarrel diverter | 16.0 x 12.0 | 6.9 | - | 0.13 | 5 | 335 | |

| | art. number | | ean code |
|-----|-------------------|---|-----------------|
| 433 | 86 107 021 433 00 | 5 | 8 711904 522836 |

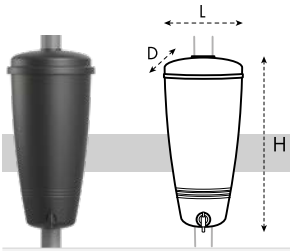

GREEN BASICS RAIN CATCHER

size = L x D, height = H

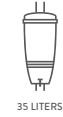

| description | | | | | | | additional information |
|---------------------------------|-------------|------|------|------|---|----|------------------------|
| green basics rain catcher 35ltr | 38.0 x 33.5 | 73.5 | 35.0 | 2.12 | 1 | 15 | |

| | art. number | | ean code | | art. number | | ean code |
|-----|-------------------|---|----------|-----|-------------------|---|----------|
| 431 | 27 466 035 431 00 | 1 | | 433 | 27 466 035 433 00 | 1 | |

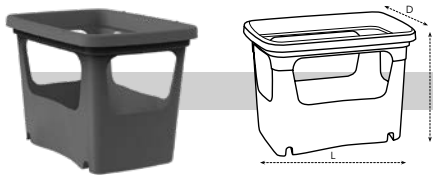

GREEN BASICS STACK & GROW

size = L x D, height = H



| description | | | | | | | additional information |
|---------------------------------|-------------|------|------|------|---|-----|------------------------|
| green basics stack & grow large | 50.9 x 35.1 | 35.7 | 15.0 | 1.08 | 5 | 160 | |

| | art. number | | ean code | | art. number | | ean code |
|-----|-------------------|---|----------|-----|-------------------|---|----------|
| 360 | 66 935 050 360 00 | 5 | | 433 | 66 935 050 433 00 | 5 | |

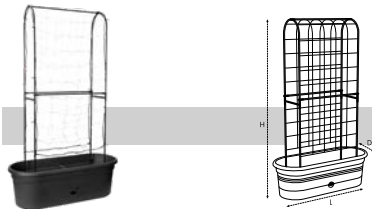

GREEN BASICS VEGGIE WALL

size = L x D, height = H



| description | | | | | | | additional information |
|-------------------------------|-------------|------|------|------|---|----|---------------------------------------------------------------------------------------------|
| green basics veggie wall 80cm | 78.0 x 32.7 | 25.1 | 37.5 | 2.14 | 1 | 45 | includes 1x stabiliser, total height of assembled product = 130cm, includes all accessories |

| | art. number | | ean code |
|-----|-------------------|---|----------|
| 433 | 05 925 078 433 00 | 1 | |

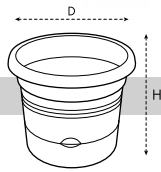

GREEN BASICS TOMATO POT

size = L x D, height = H

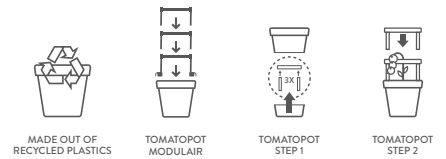

| description | | | | | | | additional information |
|------------------------------|------|------|------|------|---|----|--------------------------------------------------------------------|
| green basics tomato pot 33cm | 33.5 | 26.0 | 13.0 | 0.80 | 8 | 96 | total height of assembled product = 85cm, includes all accessories |

| art. number | ean code |
|-----------------------|-----------------|
| 433 76 250 330 433 00 | 8 711904 331634 |

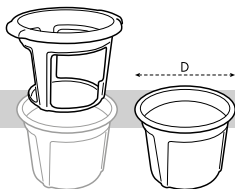

GREEN BASICS POTATO POT

size = L x D, height = H



| description | | | | | | | additional information |
|------------------------------|------|------|------|------|----|-----|--------------------------|
| green basics potato pot 33cm | 32.3 | 25.7 | 13.0 | 0.96 | 12 | 144 | includes all accessories |

| art. number | ean code |
|-----------------------|-----------------|
| 433 76 026 032 433 00 | 8 711904 315597 |

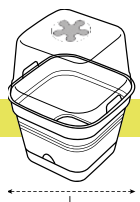

GREEN BASICS GROWPOT SQUARE ALL-IN-1

size = L x D, height = H

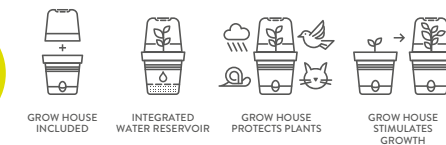

| description | | | | | | | additional information |
|-------------------------------------------|-------------|------|-----|------|----|-------|------------------------|
| green basics growpot square all-in-1 15cm | 15.0 x 15.0 | 21.9 | 1.7 | 0.16 | 10 | 1400* | |

| art. number | ean code | art. number | ean code |
|-----------------------|-----------------|-----------------------|-----------------|
| 360 66 612 015 360 00 | 8 711904 515287 | 433 66 612 015 433 00 | 8 711904 515317 |

| description | | | | | | | additional information |
|-------------------------------------------|-------------|------|-----|------|---|------|------------------------|
| green basics growpot square all-in-1 20cm | 19.5 x 19.5 | 28.4 | 3.9 | 0.29 | 5 | 840* | |

| art. number | ean code | art. number | ean code |
|-----------------------|-----------------|-----------------------|-----------------|
| 360 66 616 020 360 00 | 8 711904 515355 | 433 66 616 020 433 00 | 8 711904 515386 |

| description | | | | | | | additional information |
|-------------------------------------------|-------------|------|-----|------|---|------|------------------------|
| green basics growpot square all-in-1 25cm | 24.5 x 24.5 | 35.6 | 7.1 | 0.51 | 5 | 300* | |

| | art. number | | ean code | | art. number | | ean code |
|--|-------------------|---|----------|--|-------------------|---|----------|
| | 66 620 025 360 00 | 5 | | | 66 620 025 433 00 | 5 | |

| description | | | | | | | additional information |
|-------------------------------------------|-------------|------|------|------|---|------|------------------------|
| green basics growpot square all-in-1 30cm | 29.6 x 29.6 | 43.0 | 14.6 | 0.82 | 5 | 160* | |

| | art. number | | ean code | | art. number | | ean code |
|--|-------------------|---|----------|--|-------------------|---|----------|
| | 66 625 030 360 00 | 5 | | | 66 625 030 433 00 | 5 | |

| description | | | | | | | additional information |
|-------------------------------------------|-------------|------|------|------|---|------|------------------------|
| green basics growpot square all-in-1 35cm | 34.6 x 34.6 | 50.3 | 20.5 | 1.19 | 3 | 108* | |

| | art. number | | ean code | | art. number | | ean code |
|--|-------------------|---|----------|--|-------------------|---|----------|
| | 66 629 035 360 00 | 3 | | | 66 629 035 433 00 | 3 | |

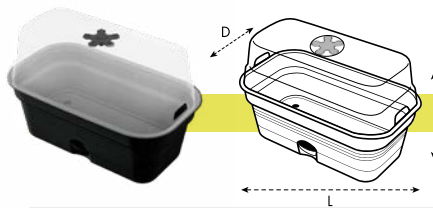

GREEN BASICS GROW TRAY ALL-IN-1

size = L x D, height = H

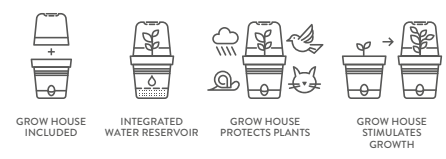

| description | | | | | | | additional information |
|-----------------------------------|-------------|------|-----|------|---|------|------------------------|
| green basics grow tray all-in-1 m | 32.0 x 18.0 | 21.6 | 4.4 | 0.43 | 5 | 490* | |

| | art. number | | ean code | | art. number | | ean code |
|--|-------------------|---|----------|--|-------------------|---|----------|
| | 66 513 032 360 00 | 5 | | | 66 513 032 433 00 | 5 | |

| description | | | | | | | additional information |
|-----------------------------------|-------------|------|-----|------|---|------|------------------------|
| green basics grow tray all-in-1 l | 39.0 x 23.0 | 25.7 | 8.5 | 0.68 | 5 | 270* | |

| | art. number | | ean code | | art. number | | ean code |
|--|-------------------|---|----------|--|-------------------|---|----------|
| | 66 515 039 360 00 | 5 | | | 66 515 039 433 00 | 5 | |

* estimated quantities

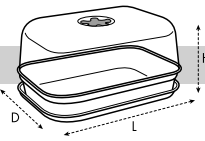

GREEN BASICS GROW KIT ALL-IN-1

size = L x D, height = H



| description | | | | | | | additional information |
|--------------------------------|-------------|------|---|------|---|----|----------------------------------------------------------------------------------------------------------|
| green basics grow kit all-in-1 | 40.0 x 30.0 | 19.9 | - | 0.91 | 4 | 72 | includes green basics grow tray medium, grow tray saucer medium, grow house medium and plantlabels small |

| | art. number | | ean code |
|-----|-------------------|---|-----------------|
| 433 | 68 931 236 433 00 | 4 | 8 711904 507534 |

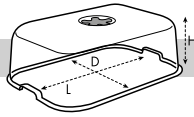

GREEN BASICS GROW HOUSE

size = L x D, height = H



| description | | | | | | | additional information |
|-------------------------------|-------------|------|---|------|---|-----|--------------------------------------------------------------------|
| green basics grow house small | 23.8 x 16.8 | 12.0 | - | 0.14 | 5 | 300 | match with green basics grow tray small and grow tray saucer small |

| | art. number | | ean code |
|-----|-------------------|---|-----------------|
| 100 | 68 712 024 100 00 | 5 | 8 711904 314613 |

| description | | | | | | | additional information |
|--------------------------------|-------------|------|---|------|---|-----|----------------------------------------------------------------------|
| green basics grow house medium | 35.8 x 25.5 | 12.9 | - | 0.28 | 5 | 400 | match with green basics grow tray medium and grow tray saucer medium |

| | art. number | | ean code |
|-----|-------------------|---|-----------------|
| 100 | 68 713 036 100 00 | 5 | 8 711904 314637 |

| description | | | | | | | additional information |
|-------------------------------|-------------|------|---|------|---|-----|--------------------------------------------------------------------|
| green basics grow house large | 51.0 x 19.5 | 12.7 | - | 0.33 | 5 | 315 | match with green basics grow tray large and grow tray saucer large |

| | art. number | | ean code |
|-----|-------------------|---|-----------------|
| 100 | 68 713 051 100 00 | 5 | 8 711904 314651 |



GREEN BASICS GROW TRAY

size = L x D, height = H



| description | | | | | | additional information |
|------------------------------|-------------|-----|-----|------|--------|---------------------------------------------------------------------|
| green basics grow tray small | 24.0 x 17.0 | 6.0 | 1.1 | 0.10 | 5 1500 | match with green basics grow tray saucer small and grow house small |

| | art. number | | ean code | | art. number | | ean code |
|-----|-------------------|---|----------|-----|-------------------|---|----------|
| 360 | 68 706 024 360 00 | 5 | | 433 | 68 706 024 433 00 | 5 | |

| description | | | | | | additional information |
|-------------------------------|-------------|-----|-----|------|-------|-----------------------------------------------------------------------|
| green basics grow tray medium | 36.0 x 26.5 | 6.3 | 2.6 | 0.24 | 5 630 | match with green basics grow tray saucer medium and grow house medium |

| | art. number | | ean code | | art. number | | ean code |
|-----|-------------------|---|----------|-----|-------------------|---|----------|
| 360 | 68 707 036 360 00 | 5 | | 433 | 68 707 036 433 00 | 5 | |

| description | | | | | | additional information |
|------------------------------|-------------|-----|-----|------|-------|---------------------------------------------------------------------|
| green basics grow tray large | 51.5 x 19.5 | 7.5 | 5.5 | 0.27 | 5 520 | match with green basics grow tray saucer large and grow house large |

| | art. number | | ean code | | art. number | | ean code |
|-----|-------------------|---|----------|-----|-------------------|---|----------|
| 360 | 68 708 051 360 00 | 5 | | 433 | 68 708 051 433 00 | 5 | |



GREEN BASICS GROW TRAY SAUCER

size = L x D, height = H

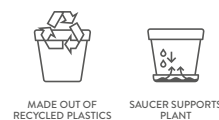

| description | | | | | | | additional information |
|-------------------------------------|-------------|-----|---|------|---|------|--------------------------------------------------------------|
| green basics grow tray saucer small | 23,5 x 16,5 | 2.5 | - | 0.07 | 5 | 2640 | match with green basics grow tray small and grow house small |

| | art. number | | ean code | | art. number | | ean code |
|-----|-------------------|---|----------|-----|-------------------|---|----------|
| 360 | 68 801 024 360 00 | 5 | | 433 | 68 801 024 433 00 | 5 | |

| description | | | | | | | additional information |
|--------------------------------------|-------------|-----|---|------|---|-----|----------------------------------------------------------------|
| green basics grow tray saucer medium | 36,0 x 25,8 | 2.2 | - | 0.15 | 5 | 900 | match with green basics grow tray medium and grow house medium |

| | art. number | | ean code | | art. number | | ean code |
|-----|-------------------|---|----------|-----|-------------------|---|----------|
| 360 | 68 802 036 360 00 | 5 | | 433 | 68 802 036 433 00 | 5 | |

| description | | | | | | | additional information |
|-------------------------------------|-------------|-----|---|------|---|-----|--------------------------------------------------------------|
| green basics grow tray saucer large | 51,0 x 19,0 | 2.4 | - | 0.16 | 5 | 960 | match with green basics grow tray large and grow house large |

| | art. number | | ean code | | art. number | | ean code |
|-----|-------------------|---|----------|-----|-------------------|---|----------|
| 360 | 68 802 050 360 00 | 5 | | 433 | 68 802 050 433 00 | 5 | |

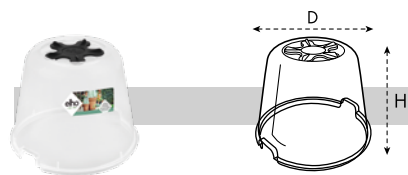

GREEN BASICS GROW HOUSE ROUND

size = L x D, height = H



| description | | | | | | | additional information |
|------------------------------------|------|------|---|------|----|-----|--------------------------------------|
| green basics grow house round 17cm | 17,0 | 13,8 | - | 0.09 | 10 | 800 | match with green basics growpot 17cm |

| | art. number | | ean code |
|-----|-------------------|----|----------|
| 100 | 69 613 017 100 00 | 10 | |

| description | | | | | | | additional information |
|------------------------------------|------|------|---|------|----|-----|--------------------------------------|
| green basics grow house round 30cm | 30.0 | 23.1 | - | 0.29 | 10 | 240 | match with green basics growpot 30cm |

| | art. number | | ean code |
|-----|-------------------|----|-----------------|
| 100 | 69 623 030 100 00 | 10 | 8 711904 304003 |

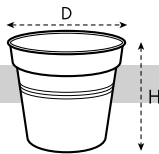

GREEN BASICS GROWPOT STARTER SET

size = L x D, height = H



| description | | | | | | | additional information |
|-------------------------------------------|-----|------|-----|------|----|------|------------------------|
| green basics growpot starter set (set/10) | 7.3 | 18.3 | 1.8 | 0.12 | 10 | 1800 | |

| | art. number | | ean code |
|-----|-------------------|----|-----------------|
| 433 | 68 107 107 433 00 | 10 | 8 711904 250249 |

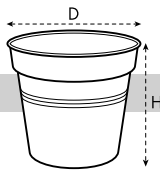

GREEN BASICS GROWPOT

size = L x D, height = H
for matching green basics saucers, see p. 326-327



| description | | | | | | | additional information |
|---------------------------|------|------|-----|------|----|------|------------------------|
| green basics growpot 11cm | 11.0 | 10.2 | 0.6 | 0.02 | 20 | 7000 | Ø10 |

| | art. number | | ean code |
|-----|-------------------|----|-----------------|
| 360 | 68 110 111 360 00 | 20 | 8 711904 299521 |

| | art. number | | ean code |
|-----|-------------------|----|-----------------|
| 453 | 68 110 111 453 00 | 20 | 8 711904 314156 |

| | art. number | | ean code |
|-----|-------------------|----|-----------------|
| 752 | 68 110 111 752 00 | 20 | 8 711904 106331 |

| | art. number | | ean code |
|-----|-------------------|----|-----------------|
| 433 | 68 110 111 433 00 | 20 | 8 711904 106362 |



| description | | | | | | | additional information |
|---------------------------|------|------|-----|------|----|------|------------------------|
| green basics growpot 13cm | 13.0 | 12.0 | 1.0 | 0.04 | 20 | 4320 | Ø10 |

| | art. number | | ean code | | art. number | | ean code | | art. number | | ean code |
|--|-------------------|----|----------|--|-------------------|----|----------|--|-------------------|----|----------|
| | 68 112 113 360 00 | 20 | | | 68 112 113 453 00 | 20 | | | 68 112 113 752 00 | 20 | |
| | 68 112 113 433 00 | 20 | | | | | | | | | |

| description | | | | | | | additional information |
|---------------------------|------|------|-----|------|----|------|------------------------|
| green basics growpot 15cm | 15.0 | 13.9 | 1.5 | 0.05 | 20 | 3200 | Ø14 |

| | art. number | | ean code | | art. number | | ean code | | art. number | | ean code |
|--|-------------------|----|----------|--|-------------------|----|----------|--|-------------------|----|----------|
| | 68 114 115 360 00 | 20 | | | 68 114 115 453 00 | 20 | | | 68 114 115 752 00 | 20 | |
| | 68 114 115 433 00 | 20 | | | | | | | | | |

| description | | | | | | | additional information |
|---------------------------|------|------|-----|------|----|------|----------------------------------------------------|
| green basics growpot 17cm | 17.1 | 15.7 | 2.1 | 0.06 | 20 | 2400 | Ø14 match with green basics grow house round 17cm |

| | art. number | | ean code | | art. number | | ean code | | art. number | | ean code |
|--|-------------------|----|----------|--|-------------------|----|----------|--|-------------------|----|----------|
| | 68 116 117 360 00 | 20 | | | 68 116 117 453 00 | 20 | | | 68 116 117 752 00 | 20 | |
| | 68 116 117 433 00 | 20 | | | | | | | | | |

| description | | | | | | | additional information |
|---------------------------|------|------|-----|------|----|------|------------------------|
| green basics growpot 19cm | 19.0 | 17.4 | 3.0 | 0.08 | 20 | 3360 | Ø17 |

| | art. number | | ean code | | art. number | | ean code | | art. number | | ean code |
|--|-------------------|----|----------|--|-------------------|----|----------|--|-------------------|----|----------|
| | 68 117 119 360 00 | 20 | | | 68 117 119 453 00 | 20 | | | 68 117 119 752 00 | 20 | |
| | 68 117 119 433 00 | 20 | | | | | | | | | |

| description | | | | | | | additional information |
|---------------------------|------|------|-----|------|----|------|------------------------|
| green basics growpot 21cm | 21.0 | 19.3 | 4.0 | 0.12 | 20 | 2160 | Ø17 |

| | art. number | | ean code | | art. number | | ean code | | art. number | | ean code |
|--|-------------------|----|----------|--|-------------------|----|----------|--|-------------------|----|----------|
| | 68 119 121 360 00 | 20 | | | 68 119 121 453 00 | 20 | | | 68 119 121 752 00 | 20 | |
| | 68 119 121 433 00 | 20 | | | | | | | | | |

| description | | | | | | | additional information |
|---------------------------|------|------|-----|------|----|------|------------------------|
| green basics growpot 24cm | 24.0 | 22.1 | 6.5 | 0.16 | 15 | 1470 | Ø22 |

| | art. number | | ean code | | art. number | | ean code | | art. number | | ean code |
|--|-------------------|----|----------|--|-------------------|----|----------|--|-------------------|----|----------|
| | 68 122 124 360 00 | 15 | | | 68 122 124 453 00 | 15 | | | 68 122 124 752 00 | 15 | |
| | 68 122 124 433 00 | 15 | | | | | | | | | |

| description | | | | | | | additional information |
|---------------------------|------|------|-----|------|----|------|------------------------|
| green basics growpot 27cm | 27.0 | 24.7 | 8.7 | 0.22 | 15 | 1155 | Ø22 |

| | art. number | | ean code | | art. number | | ean code | | art. number | | ean code |
|--|-------------------|----|----------|--|-------------------|----|----------|--|-------------------|----|----------|
| | 68 124 127 360 00 | 15 | | | 68 124 127 453 00 | 15 | | | 68 124 127 752 00 | 15 | |
| | 68 124 127 433 00 | 15 | | | | | | | | | |

| description | | | | | | | additional information |
|---------------------------|------|------|------|------|----|-----|----------------------------------------------------|
| green basics growpot 30cm | 30.0 | 27.7 | 12.0 | 0.32 | 10 | 800 | Ø25 match with green basics grow house round 30cm |

| | art. number | | ean code | | art. number | | ean code | | art. number | | ean code |
|--|-------------------|----|----------|--|-------------------|----|----------|--|-------------------|----|----------|
| | 68 128 130 360 00 | 10 | | | 68 128 130 453 00 | 10 | | | 68 128 130 752 00 | 10 | |
| | 68 128 130 433 00 | 10 | | | | | | | | | |



| description | | | | | | | additional information |
|---------------------------|------|------|------|------|---|-----|------------------------|
| green basics growpot 35cm | 35.0 | 32.2 | 19.0 | 0.43 | 5 | 450 | Ø29 |

| | art. number | | ean code | | art. number | | ean code | | art. number | | ean code |
|--|-------------------|---|----------|--|-------------------|---|----------|--|-------------------|---|----------|
| | 68 132 135 360 00 | 5 | | | 68 132 135 453 00 | 5 | | | 68 132 135 752 00 | 5 | |
| | 68 132 135 433 00 | 5 | | | | | | | | | |

| description | | | | | | | additional information |
|---------------------------|------|------|------|------|---|-----|------------------------|
| green basics growpot 40cm | 40.0 | 37.0 | 28.3 | 0.64 | 5 | 450 | Ø34 |

| | art. number | | ean code | | art. number | | ean code | | art. number | | ean code |
|--|-------------------|---|----------|--|-------------------|---|----------|--|-------------------|---|----------|
| | 68 137 140 360 00 | 5 | | | 68 137 140 453 00 | 5 | | | 68 137 140 752 00 | 5 | |
| | 68 137 140 433 00 | 5 | | | | | | | | | |

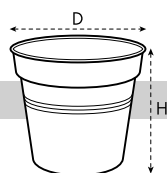

GREEN BASICS GROWPOT ORCHID

size = L x D, height = H



| description | | | | | | | additional information |
|----------------------------------|------|------|-----|------|----|------|------------------------|
| green basics growpot orchid 13cm | 13.0 | 12.0 | 1.0 | 0.04 | 10 | 4320 | Ø10 |

| | art. number | | ean code |
|--|-------------------|----|----------|
| | 68 112 113 100 00 | 10 | |

| description | | | | | | | additional information |
|----------------------------------|------|------|-----|------|----|------|------------------------|
| green basics growpot orchid 15cm | 15.0 | 13.9 | 1.5 | 0.04 | 10 | 3200 | Ø14 |

| | art. number | | ean code |
|--|-------------------|----|----------|
| | 68 114 115 100 00 | 10 | |

| description | | | | | | | additional information |
|----------------------------------|------|------|-----|------|----|------|------------------------|
| green basics growpot orchid 17cm | 17.1 | 15.7 | 2.1 | 0.06 | 20 | 2400 | Ø14 |

| | art. number | | ean code |
|-----|-------------------|----|-----------------|
| 100 | 68 116 117 100 00 | 20 | 8 711904 139995 |

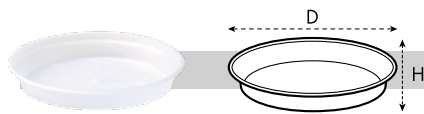

GREEN BASICS ORCHID SAUCER

size = L x D, height = H



MADE OUT OF RECYCLED PLASTICS



SAUCER SUPPORTS PLANT

| description | | | | | | | additional information |
|---------------------------------|------|-----|---|------|----|-------|---------------------------------------------|
| green basics orchid saucer 10cm | 10.0 | 1.5 | - | 0.01 | 10 | 14400 | match with green basics growpot orchid 13cm |

| | art. number | | ean code |
|-----|-------------------|----|-----------------|
| 100 | 69 902 210 100 00 | 10 | 8 711904 140021 |

| description | | | | | | | additional information |
|---------------------------------|------|-----|---|------|----|------|------------------------------------------------------|
| green basics orchid saucer 14cm | 13.5 | 1.8 | - | 0.02 | 10 | 9000 | match with green basics growpot orchid 15cm and 17cm |

| | art. number | | ean code |
|-----|-------------------|----|-----------------|
| 100 | 69 902 214 100 00 | 10 | 8 711904 140052 |

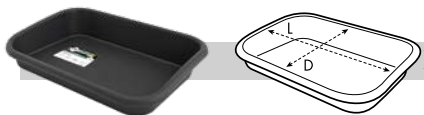

GREEN BASICS GARDEN TRAY

size = L x D, height = H



DIFFERENT WAYS TO USE

| description | | | | | | | additional information |
|--------------------------|-------------|------|-----|------|---|-----|------------------------|
| green basics garden tray | 58.5 x 42.0 | 11.0 | 9.5 | 0.86 | 5 | 110 | |

| | art. number | | ean code |
|-----|-------------------|---|-----------------|
| 360 | 68 711 059 360 00 | 5 | 8 711904 314590 |

| | art. number | | ean code |
|-----|-------------------|---|-----------------|
| 433 | 68 711 059 433 00 | 5 | 8 711904 194369 |

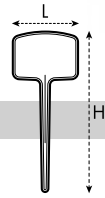

GREEN BASICS PLANTLABELS

size = L x D, height = H



| description | | | | | | | additional information |
|----------------------------------------|-----------|------|---|------|----|------|------------------------|
| green basics plantlabels small (set/5) | 6.5 x 0.3 | 12.5 | - | 0.03 | 10 | 2800 | |

| | art. number | | ean code |
|-----|-------------------|----|-----------------|
| 150 | 68 050 125 150 05 | 10 | 8 711904 194574 |

| description | | | | | | | additional information |
|-----------------------------------------|-----------|------|---|------|----|------|------------------------|
| green basics plantlabels medium (set/5) | 7.5 x 0.3 | 18.5 | - | 0.04 | 10 | 2000 | |

| | art. number | | ean code |
|-----|-------------------|----|-----------------|
| 150 | 68 050 183 150 05 | 10 | 8 711904 194604 |

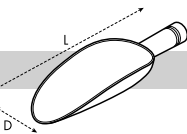
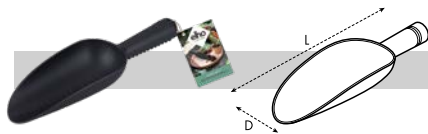

GREEN BASICS SCOOP

size = L x D, height = H



| description | | | | | | | additional information |
|--------------------------|-----------|------|---|------|----|------|------------------------|
| green basics scoop small | 7.5 x 3.8 | 26.0 | - | 0.05 | 10 | 1500 | |

| | art. number | | ean code | | art. number | | ean code |
|-----|-------------------|----|-----------------|-----|-------------------|----|-----------------|
| 360 | 68 300 100 360 00 | 10 | 8 711904 314415 | 433 | 68 300 100 433 00 | 10 | 8 711904 190255 |

| description | | | | | | | additional information |
|---------------------------|-----------|------|---|------|----|------|------------------------|
| green basics scoop medium | 8.7 x 4.2 | 30.5 | - | 0.07 | 10 | 1200 | |

| | art. number | | ean code | | art. number | | ean code |
|-----|-------------------|----|-----------------|-----|-------------------|----|-----------------|
| 360 | 68 300 200 360 00 | 10 | 8 711904 314439 | 433 | 68 300 200 433 00 | 10 | 8 711904 190286 |

grow your own

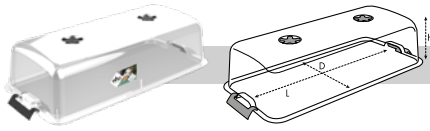

GREEN BASICS GROW HOUSE XXL

size = L x D, height = H



| description | | | | | | | additional information |
|-----------------------------|-------------|------|---|------|---|----|----------------------------------------|
| green basics grow house xxl | 74.8 x 35.5 | 20.3 | - | 1.11 | 3 | 54 | match with green basics grow table xxl |

| | art. number | | ean code |
|-----|-------------------|---|-----------------|
| 100 | 68 720 075 100 00 | 3 | 8 711904 314675 |

| description | | | | | | | additional information |
|-----------------------------------|-------------|------|---|------|---|----|----------------------------------------------|
| green basics grow house super xxl | 74.8 x 56.6 | 22.3 | - | 1.48 | 3 | 36 | match with green basics grow table super xxl |

| | art. number | | ean code |
|-----|-------------------|---|-----------------|
| 100 | 68 722 077 100 00 | 3 | 8 711904 314699 |

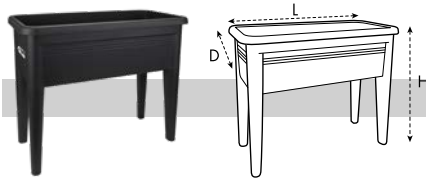

GREEN BASICS GROW TABLE XXL

size = L x D, height = H



| description | | | | | | | additional information |
|-----------------------------|-------------|------|------|------|---|----|----------------------------------------|
| green basics grow table xxl | 75.5 x 36.5 | 65.1 | 56.0 | 2.57 | 3 | 45 | match with green basics grow house xxl |

| | art. number | | ean code | | art. number | | ean code | | art. number | | ean code |
|-----|-------------------|---|-----------------|-----|-------------------|---|-----------------|-----|-------------------|---|-----------------|
| 360 | 69 265 075 360 00 | 3 | 8 711904 299859 | 397 | 69 265 075 397 00 | 3 | 8 711904 255756 | 433 | 69 265 075 433 00 | 3 | 8 711904 248710 |

| description | | | | | | | additional information |
|-----------------------------------|-------------|------|------|------|---|----|----------------------------------------------|
| green basics grow table super xxl | 75.5 x 56.3 | 73.3 | 92.0 | 3.62 | 1 | 24 | match with green basics grow house super xxl |

| | art. number | | ean code | | art. number | | ean code | | art. number | | ean code |
|-----|-------------------|---|-----------------|-----|-------------------|---|-----------------|-----|-------------------|---|-----------------|
| 360 | 69 273 077 360 00 | 1 | 8 711904 303907 | 397 | 69 273 077 397 00 | 1 | 8 711904 303921 | 433 | 69 273 077 433 00 | 1 | 8 711904 303945 |

grow your own INSTORE PRESENTATIONS



GREEN BASICS GROW YOUR OWN CONCEPT DISPLAY

- complete seasonal presentation of products: inspire & seduce your shopper!



| art. number | size lxd | | m ² | product | | qty. | | qty. | ean code |
|-------------------|----------|-----|----------------|----------------------------------------------|-----|------|-----|------|----------|
| 68 000 034 904 10 | 60 x 80 | 160 | 0.48 | green basics grow house small | 100 | 10 | | | |
| | | | | green basics grow house medium | 100 | 10 | | | |
| | | | | green basics grow house long | 100 | 10 | | | |
| | | | | green basics grow tray small | 360 | 12 | 433 | 12 | |
| | | | | green basics grow tray medium | 360 | 12 | 433 | 12 | |
| | | | | green basics grow tray long | 360 | 10 | 433 | 10 | |
| | | | | green basics grow tray saucer small | 360 | 10 | 433 | 10 | |
| | | | | green basics grow tray saucer medium | 360 | 10 | 433 | 10 | |
| | | | | green basics grow tray saucer long | 360 | 10 | 433 | 10 | |
| | | | | green basics plantlabels small (set of 5) | 150 | 10 | | | |
| | | | | green basics plantlabels medium (set of 5) | 150 | 10 | | | |
| | | | | green basics scoop small | 360 | 10 | 433 | 10 | |
| | | | | green basics scoop medium | 360 | 10 | 433 | 10 | |
| | | | | green basics grow house round 17cm | 100 | 20 | | | |
| | | | | green basics growpot starter set (set of 10) | 433 | 20 | | | |
| | | | | green basics growpot 17cm | 360 | 10 | 433 | 10 | |
| | | | | green basics saucer 14cm | 360 | 10 | 433 | 10 | |





GREEN BASICS STACK & GROW LARGE DISPLAY

- create awareness: new presentation to introduce this new unique GYO product



| art. number | size lxd | | m ² | product | | qty. | | qty. | ean code |
|-------------------|----------|-----|----------------|---------------------------------|-----|------|-----|------|-----------------|
| 66 000 001 901 10 | 120 x 80 | 100 | 0.96 | green basics stack & grow large | 360 | 20 | 433 | 36 | 8 711904 509040 |



GREEN BASICS VEGGIE WALL, TOMATO & POTATO ISLAND PRESENTATION

- complete seasonal presentation of products: seduce your shopper!



| art. number | size lxd | m ² | product | | qty. | ean code |
|-------------------|----------|----------------|-------------------------------|-----|------|-----------------|
| 05 900 002 433 10 | 120 x 80 | 0.96 | green basics veggie wall 80cm | 433 | 16 | 8 711904 485009 |
| | | | green basics tomato pot 33cm | 433 | 8 | |
| | | | green basics potato pot 33cm | 433 | 12 | |



GREEN BASICS VEGGIE WALL ISLAND PRESENTATION

- ideal presentation to boost your seasonal sales



| art. number | size lxd | m ² | product | | qty. | ean code |
|-------------------|----------|----------------|-------------------------------|-----|------|-----------------|
| 05 900 001 433 10 | 120 x 80 | 0.96 | green basics veggie wall 80cm | 433 | 24 | 8 711904 350970 |





GREEN BASICS GROW YOUR OWN CONCEPT STAND





- to inspire & activate your shopper, order a complete stand with content:

1 metal frame + 2 content = complete concept

1 METAL FRAME STAND (EMPTY)

| art. number | description | size lxd | h | m ² |  | ean code |
|-------------------|------------------------------------------|----------|-----|----------------|-------------------------------------------------------------------------------------|--------------------------------------------------------------------------------------------------------|
| 68 000 046 150 50 | green basics grow your own concept stand | 118 x 75 | 198 | 0.9 | 1 |  8 711904 304522 |

2 PRODUCTS (CONTENT FOR STAND)

| art. number | product |  | qty. | ean code |
|-------------------|----------------------------------------------|-------------------------------------------------------------------------------------|------|----------------------------------------------------------------------------------------------------------|
| 68 000 058 901 10 | green basics grow tray saucer small | 360 | 60 |  8 711904 322922 |
| | green basics grow tray saucer medium | 360 | 60 | |
| | green basics grow tray saucer long | 360 | 60 | |
| | green basics grow tray small | 360 | 50 | |
| | green basics grow tray medium | 360 | 45 | |
| | green basics grow tray long | 360 | 40 | |
| | green basics grow house small | 100 | 15 | |
| | green basics grow house medium | 100 | 15 | |
| | green basics grow house long | 100 | 15 | |
| | green basics growpot starter set (set of 10) | 433 | 30 | |
| | green basics plantlabels small (set of 5) | 150 | 10 | |
| | green basics plantlabels medium (set of 5) | 150 | 10 | |
| | green basics scoop small | 360 | 10 | |
| | green basics scoop medium | 360 | 10 | |
| | green basics grow house round 17cm | 100 | 10 | |
| | green basics growpot 17cm | 360 | 20 | |
| | green basics saucer 14cm | 360 | 80 | |
| | green basics grow house round 30cm | 100 | 10 | |
| | green basics growpot 30cm | 360 | 20 | |
| | green basics saucer 25cm | 360 | 90 | |



GREEN BASICS GROW YOUR OWN CONCEPT STAND

• to inspire & activate your shopper, order a complete stand with content:

1 metal frame + 2 content = complete concept



1 METAL FRAME STAND (EMPTY)

| art. number | description | size lxd | h | m ² | | ean code |
|-------------------|------------------------------------------|----------|-----|----------------|---|-----------------|
| 68 000 046 150 50 | green basics grow your own concept stand | 118 x 75 | 198 | 0.9 | 1 | 8 711904 304522 |

2 PRODUCTS (CONTENT FOR STAND)



| art. number | product | | qty. | ean code |
|-------------------|----------------------------------------------|-----|------|-----------------|
| 68 000 058 903 10 | green basics grow tray saucer small | 433 | 60 | 8 711904 322946 |
| | green basics grow tray saucer medium | 433 | 60 | |
| | green basics grow tray saucer long | 433 | 60 | |
| | green basics grow tray small | 433 | 50 | |
| | green basics grow tray medium | 433 | 45 | |
| | green basics grow tray long | 433 | 40 | |
| | green basics grow house small | 100 | 15 | |
| | green basics grow house medium | 100 | 15 | |
| | green basics grow house long | 100 | 15 | |
| | green basics growpot starter set (set of 10) | 433 | 30 | |
| | green basics plantlabels small (set of 5) | 150 | 10 | |
| | green basics plantlabels medium (set of 5) | 150 | 10 | |
| | green basics scoop small | 433 | 10 | |
| | green basics scoop medium | 433 | 10 | |
| | green basics grow house round 17cm | 100 | 10 | |
| | green basics growpot 17cm | 433 | 20 | |
| | green basics saucer 14cm | 433 | 80 | |
| | green basics grow house round 30cm | 100 | 10 | |
| | green basics growpot 30cm | 433 | 20 | |
| | green basics saucer 25cm | 433 | 90 | |



GREEN BASICS GROWPOT CONCEPT DISPLAY



- corex display for growpot collection: to draw attention, extra stock on shopfloor and boost extra seasonal sales
- This display has a fixed ordering & delivery period
Please order before 31.10.2022 and it will be available after 01.01.2023



| art. number | size lxd | m ² | product |  | qty. | ean code |
|--------------------------|----------|----------------|---------------------------|-------------------------------------------------------------------------------------|------|----------------------------------------------------------------------------------------------------------|
| 68 000 004 360 10 | 120 x 80 | 0.96 | green basics growpot 11cm | 360 | 60 |  8 711904 485429 |
| | | | green basics growpot 13cm | 360 | 60 | |
| | | | green basics growpot 15cm | 360 | 50 | |
| | | | green basics growpot 17cm | 360 | 40 | |
| | | | green basics growpot 19cm | 360 | 40 | |
| | | | green basics growpot 21cm | 360 | 30 | |
| | | | green basics growpot 24cm | 360 | 50 | |
| | | | green basics growpot 27cm | 360 | 40 | |
| | | | green basics growpot 30cm | 360 | 30 | |
| | | | green basics growpot 35cm | 360 | 30 | |
| | | | green basics growpot 40cm | 360 | 20 | |
| | | | green basics saucer 10cm | 360 | 75 | |
| | | | green basics saucer 14cm | 360 | 60 | |
| | | | green basics saucer 17cm | 360 | 60 | |
| | | | green basics saucer 22cm | 360 | 60 | |
| | | | green basics saucer 25cm | 360 | 30 | |
| green basics saucer 29cm | 360 | 20 | | | | |
| green basics saucer 34cm | 360 | 20 | | | | |



GREEN BASICS GROWPOT CONCEPT DISPLAY



- corex display for growpot collection: to draw attention, extra stock on shopfloor and boost extra seasonal sales
- This display has a fixed ordering & delivery period**
Please order before 31.10.2022 and it will be available after 01.01.2023



| art. number | size lxd | m ² | product |  | qty. | ean code |
|--------------------------|----------|----------------|---------------------------|-------------------------------------------------------------------------------------|------|----------------------------------------------------------------------------------------------------------|
| 68 000 004 433 10 | 120 x 80 | 0.96 | green basics growpot 11cm | 433 | 60 |  8 711904 485412 |
| | | | green basics growpot 13cm | 433 | 60 | |
| | | | green basics growpot 15cm | 433 | 50 | |
| | | | green basics growpot 17cm | 433 | 40 | |
| | | | green basics growpot 19cm | 433 | 40 | |
| | | | green basics growpot 21cm | 433 | 30 | |
| | | | green basics growpot 24cm | 433 | 50 | |
| | | | green basics growpot 27cm | 433 | 40 | |
| | | | green basics growpot 30cm | 433 | 30 | |
| | | | green basics growpot 35cm | 433 | 30 | |
| | | | green basics growpot 40cm | 433 | 20 | |
| | | | green basics saucer 10cm | 433 | 75 | |
| | | | green basics saucer 14cm | 433 | 60 | |
| | | | green basics saucer 17cm | 433 | 60 | |
| | | | green basics saucer 22cm | 433 | 60 | |
| | | | green basics saucer 25cm | 433 | 30 | |
| green basics saucer 29cm | 433 | 20 | | | | |
| green basics saucer 34cm | 433 | 20 | | | | |



GREEN BASICS GROWPOT CONCEPT DISPLAY



- corex display for growpot collection: to draw attention, extra stock on shopfloor and boost extra seasonal sales
- This display has a fixed ordering & delivery period
Please order before 31.10.2022 and it will be available after 01.01.2023





















| art. number | size lxd | m ² | product |  | qty. | ean code |
|--------------------------|----------|----------------|---------------------------|-------------------------------------------------------------------------------------|------|----------------------------------------------------------------------------------------------------------|
| 68 000 004 453 10 | 120 x 80 | 0.96 | green basics growpot 11cm | 453 | 60 |  8 711904 485436 |
| | | | green basics growpot 13cm | 453 | 60 | |
| | | | green basics growpot 15cm | 453 | 50 | |
| | | | green basics growpot 17cm | 453 | 40 | |
| | | | green basics growpot 19cm | 453 | 40 | |
| | | | green basics growpot 21cm | 453 | 30 | |
| | | | green basics growpot 24cm | 453 | 50 | |
| | | | green basics growpot 27cm | 453 | 40 | |
| | | | green basics growpot 30cm | 453 | 30 | |
| | | | green basics growpot 35cm | 453 | 30 | |
| | | | green basics growpot 40cm | 453 | 20 | |
| | | | green basics saucer 10cm | 453 | 75 | |
| | | | green basics saucer 14cm | 453 | 60 | |
| | | | green basics saucer 17cm | 453 | 60 | |
| | | | green basics saucer 22cm | 453 | 60 | |
| | | | green basics saucer 25cm | 453 | 30 | |
| green basics saucer 29cm | 453 | 20 | | | | |
| green basics saucer 34cm | 453 | 20 | | | | |



GREEN BASICS GROWPOT CONCEPT DISPLAY



- corex display for growpot collection: to draw attention, extra stock on shopfloor and boost extra seasonal sales
- This display has a fixed ordering & delivery period
Please order before 31.10.2022 and it will be available after 01.01.2023

| art. number | size lxd | m ² | product |  | qty. | ean code |
|--------------------------|---------------------------------------------------------------------------------------|----------------|---------------------------|---------------------------------------------------------------------------------------|------|----------------------------------------------------------------------------------------------------------|
| 68 000 004 752 10 | 120 x 80 | 0.96 | green basics growpot 11cm |  | 60 |  8 711904 485443 |
| | | | green basics growpot 13cm |  | 60 | |
| | | | green basics growpot 15cm |  | 50 | |
| | | | green basics growpot 17cm |  | 40 | |
| | | | green basics growpot 19cm |  | 40 | |
| | | | green basics growpot 21cm |  | 30 | |
| | | | green basics growpot 24cm |  | 50 | |
| | | | green basics growpot 27cm |  | 40 | |
| | | | green basics growpot 30cm |  | 30 | |
| | | | green basics growpot 35cm |  | 30 | |
| | | | green basics growpot 40cm |  | 20 | |
| | | | green basics saucer 10cm |  | 75 | |
| | | | green basics saucer 14cm |  | 60 | |
| | | | green basics saucer 17cm |  | 60 | |
| | | | green basics saucer 22cm |  | 60 | |
| | | | green basics saucer 25cm |  | 30 | |
| green basics saucer 29cm |  | 20 | | | | |
| green basics saucer 34cm |  | 20 | | | | |





GREEN BASICS GROWPOT CONCEPT STAND

- to inspire & activate your shopper, order a complete stand with content:



1 metal frame + 2 content = complete concept



1 METAL FRAME STAND (EMPTY)

| art. number | description | size lxd | h | m ² |  | ean code |
|-------------------|------------------------------------|----------|-----|----------------|-------------------------------------------------------------------------------------|--------------------------------------------------------------------------------------------------------|
| 68 000 047 150 50 | green basics growpot concept stand | 102 x 68 | 198 | 0.7 | 1 |  8 711904 304539 |

2 PRODUCTS (CONTENT FOR STAND)

| art. number | product |  | qty. | ean code |
|--------------------------|---------------------------|-------------------------------------------------------------------------------------|------|----------------------------------------------------------------------------------------------------------|
| 68 000 051 360 10 | green basics growpot 11cm | 360 | 60 |  8 711904 306380 |
| | green basics growpot 13cm | 360 | 60 | |
| | green basics growpot 15cm | 360 | 60 | |
| | green basics growpot 17cm | 360 | 40 | |
| | green basics growpot 19cm | 360 | 40 | |
| | green basics growpot 21cm | 360 | 40 | |
| | green basics growpot 24cm | 360 | 30 | |
| | green basics growpot 27cm | 360 | 30 | |
| | green basics growpot 30cm | 360 | 20 | |
| | green basics growpot 35cm | 360 | 20 | |
| | green basics growpot 40cm | 360 | 15 | |
| | green basics saucer 10cm | 360 | 100 | |
| | green basics saucer 14cm | 360 | 80 | |
| | green basics saucer 17cm | 360 | 100 | |
| | green basics saucer 22cm | 360 | 105 | |
| | green basics saucer 25cm | 360 | 90 | |
| | green basics saucer 29cm | 360 | 90 | |
| green basics saucer 34cm | 360 | 80 | | |

| art. number | product |  | qty. | ean code |
|-------------------|-------------------------------------------------------------------------------------------------|-------------------------------------------------------------------------------------|------|--------------------------------------------------------------------------------------------------------|
| 68 000 051 433 10 | green basics growpots + saucers (same content as 6800005136010 only with 433 instead of 360) | 433 | 100% |  8 711904 306397 |
| 68 000 051 453 10 | green basics growpots + saucers (same content as 6800005136010 only with 453 instead of 360) | 453 | 100% |  8 711904 318543 |
| 68 000 051 752 10 | green basics growpots + saucers (same content as 6800005136010 only with 752 instead of 360) | 752 | 100% |  8 711904 306410 |



GREEN BASICS GROWPOT SQUARE ALL-IN-1 STAND



- to inspire & activate your shopper, order a complete stand with content:

1 metal frame + 2 content = complete concept



NEW





1 METAL FRAME STAND (EMPTY)

| art. number | description | size lxd | h | m ² |  | ean code |
|-------------------|--------------------------------------------|----------|-----|----------------|---------------------------------------------------------------------------------------|----------------------------------------------------------------------------------------------------------|
| 66 000 001 901 50 | green basics growpot square all-in-1 stand | 119 x 74 | 198 | 0.88 | 1 |  8 711904 523527 |

2 PRODUCTS (CONTENT FOR STAND)

| art. number | product |  | qty. | ean code |
|-------------------|-------------------------------------------|---------------------------------------------------------------------------------------|------|----------------------------------------------------------------------------------------------------------|
| 66 600 023 360 10 | green basics growpot square all-in-1 15cm | 360 | 40 |  8 711904 523701 |
| | green basics growpot square all-in-1 20cm | 360 | 30 | |
| | green basics growpot square all-in-1 25cm | 360 | 20 | |
| | green basics growpot square all-in-1 30cm | 360 | 20 | |
| | green basics growpot square all-in-1 35cm | 360 | 15 | |
| | green basics grow tray all-in-1 m | 360 | 15 | |
| | green basics grow tray all-in-1 l | 360 | 15 | |





| art. number | product |  | qty. | ean code |
|-------------------|-------------------------------------------|-------------------------------------------------------------------------------------|------|--------------------------------------------------------------------------------------------------------|
| 66 600 023 433 10 | green basics growpot square all-in-1 15cm | 433 | 40 |  8 711904 523695 |
| | green basics growpot square all-in-1 20cm | 433 | 30 | |
| | green basics growpot square all-in-1 25cm | 433 | 20 | |
| | green basics growpot square all-in-1 30cm | 433 | 20 | |
| | green basics growpot square all-in-1 35cm | 433 | 15 | |
| | green basics grow tray all-in-1 m | 433 | 15 | |
| | green basics grow tray all-in-1 l | 433 | 15 | |







GREEN BASICS GROWPOT SQUARE ALL-IN-1 DISPLAY

- inspire your shopper, present this unique new product on a high-traffic location in your store



| art. number | size lxd |  | m ² | product |  | qty. | ean code |
|-------------------|----------|-------------------------------------------------------------------------------------|----------------|-------------------------------------------|---------------------------------------------------------------------------------------|------|----------------------------------------------------------------------------------------------------------|
| 66 600 001 360 10 | 60 x 80 | 100 | 0.48 | green basics growpot square all-in-1 20cm | 360 | 42 |  8 711904 523732 |
| | | | | green basics growpot square all-in-1 25cm | 360 | 24 | |
| | | | | green basics growpot square all-in-1 30cm | 360 | 20 | |

| art. number | size lxd |  | m ² | product |  | qty. | ean code |
|-------------------|----------|-------------------------------------------------------------------------------------|----------------|-------------------------------------------|---------------------------------------------------------------------------------------|------|----------------------------------------------------------------------------------------------------------|
| 66 600 001 433 10 | 60 x 80 | 100 | 0.48 | green basics growpot square all-in-1 20cm | 433 | 42 |  8 711904 523749 |
| | | | | green basics growpot square all-in-1 25cm | 433 | 24 | |
| | | | | green basics growpot square all-in-1 30cm | 433 | 20 | |





| art. number | size lxd |  | m ² | product |  | qty. |  | qty. | ean code |
|-------------------|----------|-----------------------------------------------------------------------------------|----------------|-------------------------------------------|-------------------------------------------------------------------------------------|------|-------------------------------------------------------------------------------------|------|--------------------------------------------------------------------------------------------------------|
| 66 600 001 901 10 | 60 x 80 | 100 | 0.48 | green basics growpot square all-in-1 20cm | 360 | 21 | 433 | 21 |  8 711904 523756 |
| | | | | green basics growpot square all-in-1 25cm | 360 | 12 | 433 | 12 | |
| | | | | green basics growpot square all-in-1 30cm | 360 | 10 | 433 | 10 | |



GREEN BASICS GROWPOT & GROW HOUSE ROUND DISPLAY

- ideal presentation to boost your seasonal sales





| art. number | size lxd |  | m ² | product |  | qty. |  | qty. |  | qty. | ean code |
|-------------------|----------|-----------------------------------------------------------------------------------|----------------|------------------------------------|-------------------------------------------------------------------------------------|------|-------------------------------------------------------------------------------------|------|-------------------------------------------------------------------------------------|------|---------------------------------------------------------------------------------------------------------|
| 68 000 048 902 10 | 60 x 80 | 100 | 0.48 | green basics growpot 30cm | 360 | 47 | 433 | 47 | 752 | 47 |  8 711904 305796 |
| | | | | green basics grow house round 30cm | 100 | 27 | | | | | |





GREEN BASICS GROW TABLE SUPER XXL ISLAND PRESENTATION

- best-selling #1 display: a musthave for your shopfloor



| art. number | size lxd | m ² | product |  | qty. |  | qty. | ean code |
|-------------------|----------|----------------|-----------------------------------|---------------------------------------------------------------------------------------|------|---------------------------------------------------------------------------------------|------|----------------------------------------------------------------------------------------------------------|
| 69 000 011 901 10 | 120 x 80 | 0.96 | green basics grow table super xxl | 360 | 6 | 433 | 6 |  8 711904 322953 |
| | | | green basics grow house super xxl | 100 | 6 | | | |

| art. number | size lxd | m ² | product |  | qty. |  | qty. | ean code |
|-------------------|----------|----------------|-----------------------------------|---------------------------------------------------------------------------------------|------|---------------------------------------------------------------------------------------|------|----------------------------------------------------------------------------------------------------------|
| 69 000 011 902 10 | 120 x 80 | 0.96 | green basics grow table super xxl | 397 | 6 | 433 | 6 |  8 711904 322960 |
| | | | green basics grow house super xxl | 100 | 6 | | | |



GREEN BASICS GROW TABLE XXL ISLAND PRESENTATION

- best-selling #1 display: a musthave for your shopfloor



| art. number | size lxd | m ² | product | | qty. | | qty. | ean code |
|-------------------|----------|----------------|-----------------------------|-----|------|-----|------|-----------------|
| 69 000 012 901 10 | 120 x 80 | 0.96 | green basics grow table xxl | 360 | 9 | 433 | 9 | 8 711904 322977 |
| | | | green basics grow house xxl | 100 | 9 | | | |

| art. number | size lxd | m ² | product | | qty. | | qty. | ean code |
|-------------------|----------|----------------|-----------------------------|-----|------|-----|------|-----------------|
| 69 000 012 902 10 | 120 x 80 | 0.96 | green basics grow table xxl | 397 | 9 | 433 | 9 | 8 711904 322984 |
| | | | green basics grow house xxl | 100 | 9 | | | |

| art. number | size lxd | m ² | product | | qty. | | qty. | ean code |
|-------------------|----------|----------------|-----------------------------|-----|------|-----|------|-----------------|
| 69 000 013 901 10 | 120 x 80 | 0.96 | green basics grow table xxl | 360 | 6 | 433 | 12 | 8 711904 322991 |
| | | | green basics grow house xxl | 100 | 9 | | | |

| art. number | size lxd | m ² | product | | qty. | | qty. | ean code |
|-------------------|----------|----------------|-----------------------------|-----|------|-----|------|-----------------|
| 69 000 013 902 10 | 120 x 80 | 0.96 | green basics grow table xxl | 397 | 6 | 433 | 12 | 8 711904 323004 |
| | | | green basics grow house xxl | 100 | 9 | | | |

| art. number | size lxd | m ² | product | | qty. | | qty. | ean code |
|-------------------|----------|----------------|-----------------------------|--|------|-----|------|-----------------|
| 69 000 014 901 10 | 120 x 80 | 0.96 | green basics grow table xxl | | | 433 | 18 | 8 711904 323042 |
| | | | green basics grow house xxl | | | 100 | 9 | |



GREEN BASICS GROWPOT SQUARE ALL-IN-1



NOA

Grow your own vegetables, fruit and herbs with the new worry free noa grow table! The integrated water reservoir with convenient water level indicator ensures that your plants always have sufficient water. The water reservoir is easy to fill with a watering can via the watering funnel. The matching grow house gives your plants the best growth climate and protects against birds, heavy rain and direct sunlight. Other features like a tray to store your accessories, removable legs for easy storage and a plug to remove excess water complete the grow table.



NICE THINGS TO KNOW ABOUT THE FAMILY

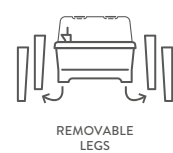

grow table

NEW
PRODUCT

colours

368

403

433



grow your own noa COLLECTION

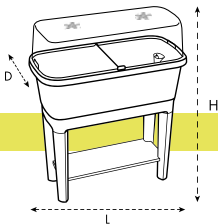

NOA GROW TABLE

size = L x D, height = H

NEW



PLUG TO DRAIN EXCESS WATER



WATER LEVEL INDICATION



WATER SYSTEM SUPPORTS PLANT

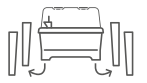

REMOVABLE LEGS

| description | ◀▶ | 🗑️ | 💧 | 📊 | 📱 | 🏠 | additional information |
|----------------|---------------|------|------|------|---|-----|------------------------|
| noa grow table | 78.5x 38.7 | 93.5 | 64.0 | 4.97 | 3 | 27* | |

| 📱 | art. number | 📱 | ean code | 📱 | art. number | 📱 | ean code | 📱 | art. number | 📱 | ean code |
|-----|-------------------|---|----------|-----|-------------------|---|----------|-----|-------------------|---|----------|
| 368 | 67 193 080 368 00 | 3 | | 403 | 67 193 080 403 00 | 3 | | 433 | 67 193 080 433 00 | 3 | |



NOA GROW TABLE



GROW YOUR OWN INDOOR

The new collection to grow your own indoor! Products with a beautiful, modern design in ton-sur-ton colours. Real eyecatchers in the kitchen or windowsill. The bouncy basil with floating watering system keeps your herbs fresh and healthy. With the magic microgreens you grow your own microgreens year round. In 5 days to 3 weeks, depending on the chosen microgreens, you can already harvest this superfood. The amazing avocado pot and floater make it possible to grow your own avocado plant. A fun way to make your home a little greener !

NICE THINGS TO KNOW ABOUT THE FAMILY

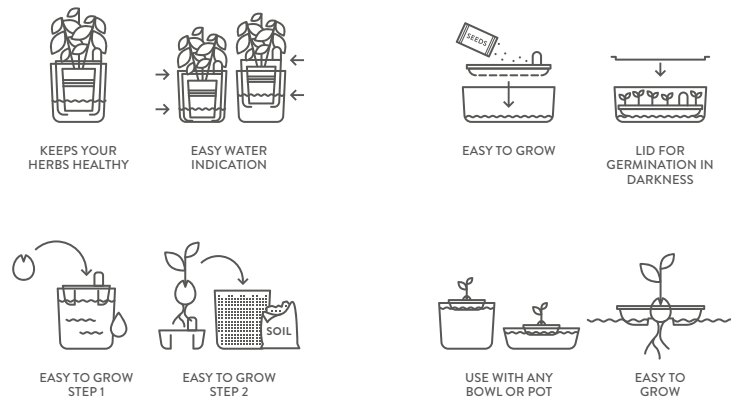

colours

| | |
|-----|-----|
| 360 | 755 |
| 367 | 754 |

NEW
PRODUCT
FAMILY

grow your own indoor COLLECTION

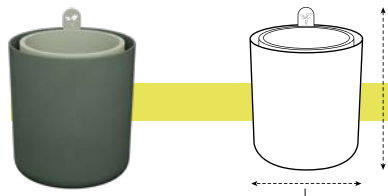

BOUNCY BASIL

size = L x D, height = H



| description | | | | | | | additional information |
|--------------|------|------|-----|------|---|------|------------------------|
| bouncy basil | 16.5 | 21.0 | 3.6 | 0.52 | 3 | 450* | |

| | art. number | | ean code | | art. number | | ean code |
|-----|-------------------|---|-----------------|-----|-------------------|---|-----------------|
| 360 | 72 721 017 360 00 | 3 | | 755 | 72 721 017 755 00 | 3 | |
| 367 | | | 8 711904 520892 | 754 | | | 8 711904 520861 |

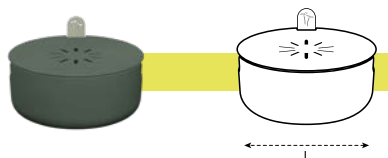

MAGIC MICROGREENS

size = L x D, height = H



| description | | | | | | | additional information |
|-------------------|------|------|-----|------|---|------|------------------------|
| magic microgreens | 16.8 | 10.2 | 0.7 | 0.43 | 4 | 480* | |

| | art. number | | ean code | | art. number | | ean code |
|-----|-------------------|---|-----------------|-----|-------------------|---|-----------------|
| 360 | 72 607 017 360 00 | 4 | | 755 | 72 607 017 755 00 | 4 | |
| 367 | | | 8 711904 520755 | 754 | | | 8 711904 520724 |

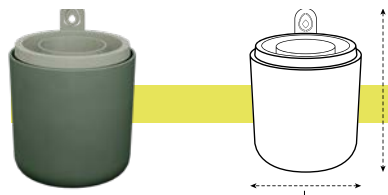

AMAZING AVOCADO POT

size = L x D, height = H



| description | | | | | | | additional information |
|---------------------|------|------|-----|------|---|------|------------------------|
| amazing avocado pot | 12.0 | 15.1 | 1.0 | 0.18 | 6 | 180* | |

| | art. number | | ean code | | art. number | | ean code |
|-----|-------------------|---|-----------------|-----|-------------------|---|-----------------|
| 360 | 72 412 012 360 00 | 6 | | 755 | 72 412 012 755 00 | 6 | |
| 367 | | | 8 711904 519520 | 754 | | | 8 711904 519490 |

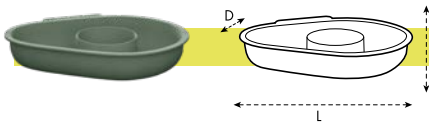

AMAZING AVOCADO FLOATER

size = L x D, height = H



| description | ↔ | 🗑️ | 💧 | 📦 | 📦 | 📦 | additional information |
|-------------------------|-------------|-----|---|------|----|-------|------------------------|
| amazing avocado floater | 14.8 x 11.0 | 2.7 | - | 0.03 | 10 | 2300* | |

| 🗑️ | art. number | 📦 | ean code |
|-----|-------------------|----|-----------------------------------------------------------------------------------|
| 360 | 72 503 015 360 00 | 10 |  |

grow your own indoor INSTORE PRESENTATIONS



GROW YOUR OWN INDOOR FLOOR STAND

NEW



- to inspire & activate your shopper, order a complete stand with content:

1 metal frame + 2 content = complete concept

1 METAL FRAME STAND (EMPTY)

| art. number | description | size lxd | h | m ² | | ean code |
|-------------------|----------------------------------|----------|-----|----------------|---|------------------|
| 72 000 000 901 50 | grow your own indoor floor stand | 80 x 53 | 198 | 0.42 | 1 | 8 711904 1523602 |

2 PRODUCTS (CONTENT FOR STAND)

| art. number | product | | qty. | | qty. | ean code |
|-------------------|-------------------------|-----|------|-----|------|------------------|
| 72 000 003 902 10 | amazing avocado pot | 360 | 12 | 755 | 12 | 8 711904 1524135 |
| | magic microgreens | 360 | 12 | 755 | 12 | |
| | bouncy basil | 360 | 12 | 755 | 12 | |
| | amazing avocado floater | 360 | 30 | | | |



GROW YOUR OWN INDOOR CONCEPT DISPLAY

NEW



- inspire your shopper, present this unique new family on a high-traffic location in your store



| art. number | size lxd | | m ² | product | | qty. | | qty. | ean code |
|-------------------|----------|-----|----------------|---------------------|-----|------|-----|------|------------------|
| 72 000 003 901 10 | 60 x 40 | 160 | 0.24 | amazing avocado pot | 360 | 6 | 755 | 6 | 8 711904 1524142 |
| | | | | magic microgreens | 360 | 9 | 755 | 9 | |
| | | | | bouncy basil | 360 | 10 | 755 | 10 | |



AVOCADO FLOATER COUNTER DISPLAY

- inspire your shopper, present this unique new family on a high-traffic location in your store



| art. number | size lxd |  | m ² | product |  | qty. | ean code |
|-------------------|----------|-----------------------------------------------------------------------------------|----------------|-------------------------|-------------------------------------------------------------------------------------|------|-----------------------------------------------------------------------------------------------------|
| 72 000 004 360 10 | 20 x 50 | 51 | 0.1 | amazing avocado floater | 360 | 32 |  8 711904 524159 |



LIGHT CARE

For every need we have a special lighting product. If you would like to grow your own veggies or herbs indoor, the light garden is perfect for you. With our plant light garden your smaller houseplants will stay healthy. Your bigger houseplants will be happy with some extra light care from the leaf light care.



light garden

grow your own veggies and fresh herbs



plant light care

keep your smaller houseplants healthy



leaf light care

give your big plants some extra light (care)



NICE THINGS TO KNOW ABOUT THE FAMILY



LED LIGHT



DAY/NIGHT CYCLE



MANUAL



EU/UK PLUG

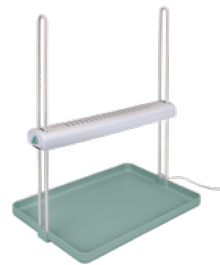

light garden



plant light care



leaf light care



colours

360

419

433



WATCH THE LIGHT CARE PRODUCT PAGE



lightcare COLLECTION

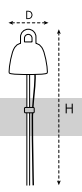



LEAF LIGHT CARE
size = L x D, height = H

- LED CYCLE 15 HOURS
- EXTENDABLE 103cm
- LED LIGHT 3.5W
- 3 METER CABLE
- MANUAL
- EU/UK PLUG
- NO TOOLS NEEDED

| description | | | | | | | additional information |
|-----------------|-----------|------|---|------|---|-----|-----------------------------------------------------|
| leaf light care | 7.3 x 7.3 | 36.0 | - | 0.36 | 1 | 420 | manual in NL - UK - FR - DE - ES - IT - SE included |

| | art. number | | ean code | | art. number | | ean code |
|-----|-------------------|---|----------|-----|-------------------|---|----------|
| 360 | 06 136 007 360 00 | 1 | | 433 | 06 136 007 433 00 | 1 | |

PLANT LIGHT CARE
size = L x D, height = H

- LED CYCLE 15 HOURS
- 3 METER CABLE
- LED LIGHT 3.5W
- MANUAL
- EU/UK PLUG
- NO TOOLS NEEDED

| description | | | | | | | additional information |
|------------------|------|------|---|------|---|-----|-------------------------------------------------------------------------------------|
| plant light care | 25.0 | 47.0 | - | 0.50 | 5 | 120 | counterdisplay with 5 products, manual in NL - UK - FR - DE - ES - IT - SE included |

| | art. number | | ean code |
|-----|-------------------|---|----------|
| 419 | 17 119 001 419 00 | 5 | |



LIGHT GARDEN
size = L x D, height = H

- LED LIGHT 12-18 HOURS
- 1.5 METER CABLE
- LED LIGHT 3.5W
- MANUAL
- EU/UK PLUG
- NO TOOLS NEEDED

| description | | | | | | | additional information |
|--------------|-------------|------|---|------|---|-----|-------------------------------------------------------------------------------------|
| light garden | 39.0 x 26.0 | 48.0 | - | 1.30 | 5 | 120 | counterdisplay with 5 products, manual in NL - UK - FR - DE - ES - IT - SE included |

| | art. number | | ean code |
|-----|-------------------|---|----------|
| 360 | 17 319 002 360 00 | 5 | |

light care INSTORE PRESENTATIONS



LEAF LIGHT CARE TABLE STAND

- to inspire & activate your shopper, order a complete stand with content:

1 metal frame + 2 content = complete concept



1 METAL FRAME STAND (EMPTY)

| art. number | description | size lxd | h | m ² | | ean code |
|-------------------|-----------------------------|----------|-----|----------------|---|-----------------|
| 06 100 001 150 50 | leaf light care table stand | 74 x 45 | 120 | 0.33 | 1 | 8 711904 351458 |

2 PRODUCTS (CONTENT FOR STAND)

| art. number | product | | qty. | | qty. | ean code |
|-------------------|-----------------|-----|------|-----|------|-----------------|
| 06 100 001 901 10 | leaf light care | 360 | 9 | 433 | 9 | 8 711904 351526 |

PACKAGING UNIT LIGHT GARDEN AND PLANT LIGHT CARE

These products are standard delivered in a shelf-ready full coloured display box with header.

Each display contains 5 products (packaging unit: 5), each product packed separate in sealed boxes.







exclusives
COLLECTION



PURE

Our Dutch design team is dedicated to surprise you with unique and breakthrough innovations every year. Premium design pots for conscious green living. Perfect for in- and outdoor use. Light weight, frost proof, long-lasting colours due to revolutionary weather & UV protection. 10-year warranty.

NICE THINGS TO KNOW ABOUT THE FAMILY



PREMIUM QUALITY



10 YEAR GUARANTEE



INDOOR AND OUTDOOR USE



LIGHT WEIGHT



LONG-LASTING COLOUR



FROST PROOF



coupe



beads



edge



cone



soft brick wheels



soft round



round



straight round



raindrop



colours

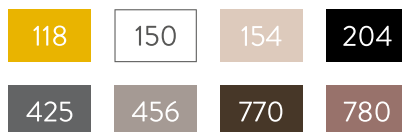

pure COLLECTION

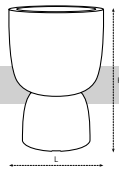

PURE COUPE

size = L x D, height = H



10 YEAR GUARANTEE



INDOOR AND OUTDOOR USE



ELEVATED BOTTOM LESS SOIL NEEDED



REMOVABLE CAP



BOTTOM CAN BE FILLED WITH SAND

| description | | | | | | | additional information | |
|-----------------|--|-------------|------|------|------|---|------------------------|-------------------------------------|
| pure coupe 35cm | | 34.9 x 34.9 | 49.0 | 15.0 | 2.33 | 1 | 36 | match with self-watering insert Ø28 |

| | art. number | | ean code | | art. number | | ean code | | art. number | | ean code | | | | | | |
|--|-------------|-------------------|----------|--|-----------------|--|----------|-------------------|-------------|--|-----------------|--|-----|-------------------|---|--|-----------------|
| | 204 | 29 147 034 204 00 | 1 | | 8 711904 492649 | | 456 | 29 147 034 456 00 | 1 | | 8 711904 498719 | | 780 | 29 147 034 780 00 | 1 | | 8 711904 498726 |

| description | | | | | | | additional information | |
|-----------------|--|-------------|------|------|------|---|------------------------|-------------------------------------|
| pure coupe 41cm | | 41.3 x 41.3 | 57.9 | 25.0 | 3.27 | 1 | 20 | match with self-watering insert Ø33 |

| | art. number | | ean code | | art. number | | ean code | | art. number | | ean code | | | | | | |
|--|-------------|-------------------|----------|--|-----------------|--|----------|-------------------|-------------|--|-----------------|--|-----|-------------------|---|--|-----------------|
| | 204 | 29 257 041 204 00 | 1 | | 8 711904 492700 | | 456 | 29 257 041 456 00 | 1 | | 8 711904 498733 | | 780 | 29 257 041 780 00 | 1 | | 8 711904 498740 |

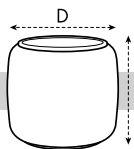

PURE BEADS SMALL

size = L x D, height = H



10 YEAR GUARANTEE



INDOOR AND OUTDOOR USE



ELEVATED BOTTOM LESS SOIL NEEDED



REMOVABLE CAP



BOTTOM CAN BE FILLED WITH SAND

| description | | | | | | | additional information | |
|---------------------|--|------|------|------|------|---|------------------------|-------------------------------------|
| pure beads small 40 | | 39.2 | 34.8 | 12.5 | 2.38 | 1 | 30 | match with self-watering insert Ø28 |

| | art. number | | ean code | | art. number | | ean code | | art. number | | ean code | | | | | | |
|--|-------------|-------------------|----------|--|-----------------|--|----------|-------------------|-------------|--|-----------------|--|-----|-------------------|---|--|-----------------|
| | 154 | 05 534 931 154 00 | 1 | | 8 711904 350161 | | 456 | 05 534 931 456 00 | 1 | | 8 711904 350123 | | 770 | 05 534 931 770 00 | 1 | | 8 711904 350147 |

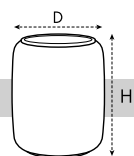

PURE BEADS MEDIUM

size = L x D, height = H



10 YEAR GUARANTEE



INDOOR AND OUTDOOR USE



ELEVATED BOTTOM LESS SOIL NEEDED



REMOVABLE CAP



BOTTOM CAN BE FILLED WITH SAND

| description | Ø | h | Ltr | Kg | art. number | ean code | additional information |
|----------------------|------|------|------|------|-------------|----------|-------------------------------------|
| pure beads medium 40 | 39.2 | 47.2 | 12.5 | 3.58 | 1 | 24 | match with self-watering insert Ø28 |

| art. number | ean code | art. number | ean code | art. number | ean code |
|-------------|-------------------|-------------|-------------------|-------------|-------------------|
| 154 | 05 647 631 154 00 | 456 | 05 647 631 456 00 | 770 | 05 647 631 770 00 |
| 1 | 8 711904 350222 | 1 | 8 711904 350185 | 1 | 8 711904 350208 |

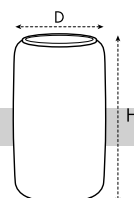

PURE BEADS LARGE

size = L x D, height = H



10 YEAR GUARANTEE



INDOOR AND OUTDOOR USE



ELEVATED BOTTOM LESS SOIL NEEDED



REMOVABLE CAP



BOTTOM CAN BE FILLED WITH SAND

| description | Ø | h | Ltr | Kg | art. number | ean code | additional information |
|---------------------|------|------|------|------|-------------|----------|-------------------------------------|
| pure beads large 40 | 39.2 | 65.7 | 12.5 | 3.94 | 1 | 18 | match with self-watering insert Ø28 |

| art. number | ean code | art. number | ean code | art. number | ean code |
|-------------|-------------------|-------------|-------------------|-------------|-------------------|
| 154 | 05 766 531 154 00 | 456 | 05 766 531 456 00 | 770 | 05 766 531 770 00 |
| 1 | 8 711904 350284 | 1 | 8 711904 350246 | 1 | 8 711904 350260 |

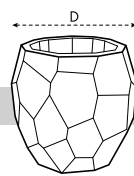

PURE EDGE

size = L x D, height = H



10 YEAR GUARANTEE



INDOOR AND OUTDOOR USE



ELEVATED BOTTOM LESS SOIL NEEDED



REMOVABLE CAP



BOTTOM CAN BE FILLED WITH SAND

| description | Ø | h | Ltr | Kg | art. number | ean code | additional information |
|--------------|------|------|------|------|-------------|----------|------------------------|
| pure edge 40 | 39.5 | 37.6 | 12.0 | 2.42 | 1 | 24 | |

| art. number | ean code | art. number | ean code |
|-------------|-------------------|-------------|-------------------|
| 150 | 89 238 040 150 00 | 425 | 89 238 040 425 00 |
| 1 | 8 711904 316389 | 1 | 8 711904 316396 |



| description | | | | | | | additional information |
|--------------|------|------|------|------|---|----|------------------------|
| pure edge 47 | 47.0 | 44.6 | 18.0 | 4.03 | 1 | 12 | |

| | art. number | | ean code | | art. number | | ean code |
|-----|-------------------|---|-----------------|-----|-------------------|---|-----------------|
| 150 | 89 245 047 150 00 | 1 | 8 711904 316402 | 425 | 89 245 047 425 00 | 1 | 8 711904 316419 |

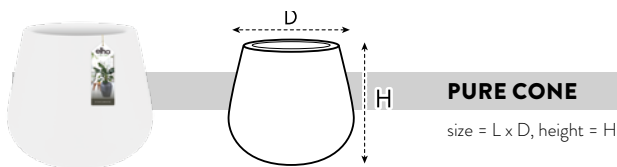

| description | | | | | | | additional information |
|--------------|------|------|------|------|---|----|------------------------|
| pure cone 45 | 43.0 | 36.3 | 13.0 | 2.36 | 1 | 16 | |

| | art. number | | ean code | | art. number | | ean code |
|-----|-------------------|---|-----------------|-----|-------------------|---|-----------------|
| 150 | 89 936 043 150 00 | 1 | 8 711904 250706 | 204 | 89 936 043 204 00 | 1 | 8 711904 253394 |

| description | | | | | | | additional information |
|--------------|------|------|------|------|---|---|------------------------|
| pure cone 55 | 55.0 | 46.5 | 24.0 | 6.19 | 1 | 6 | |

| | art. number | | ean code | | art. number | | ean code |
|-----|-------------------|---|-----------------|-----|-------------------|---|-----------------|
| 150 | 89 946 055 150 00 | 1 | 8 711904 271688 | 204 | 89 946 055 204 00 | 1 | 8 711904 271701 |

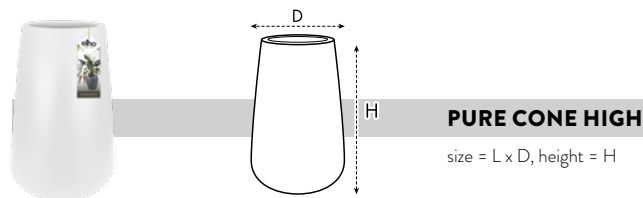

| description | | | | | | | additional information |
|-------------------|------|------|------|------|---|----|------------------------|
| pure cone high 45 | 42.0 | 66.0 | 13.0 | 3.58 | 1 | 15 | |

| | art. number | | ean code | | art. number | | ean code | | art. number | | ean code |
|-----|-------------------|---|-----------------|-----|-------------------|---|-----------------|-----|-------------------|---|-----------------|
| 118 | 89 966 043 118 00 | 1 | 8 711904 253493 | 150 | 89 966 043 150 00 | 1 | 8 711904 250782 | 204 | 89 966 043 204 00 | 1 | 8 711904 253516 |

| description | | | | | | | additional information |
|-------------------|------|------|------|------|---|---|------------------------|
| pure cone high 55 | 50.2 | 84.0 | 22.0 | 5.50 | 1 | 4 | |

| | art. number | | ean code | | art. number | | ean code | | art. number | | ean code |
|-----|-------------------|---|-----------------|-----|-------------------|---|-----------------|-----|-------------------|---|-----------------|
| 118 | 89 984 052 118 00 | 1 | 8 711904 274979 | 150 | 89 984 052 150 00 | 1 | 8 711904 250829 | 204 | 89 984 052 204 00 | 1 | 8 711904 253554 |

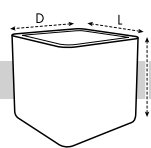

PURE SOFT BRICK WHEELS

size = L x D, height = H



| description | | | | | | | additional information |
|---------------------------|-------------|------|------|------|---|----|------------------------|
| pure soft brick wheels 40 | 39.0 x 39.0 | 39.0 | 23.0 | 3.69 | 1 | 30 | |

| | art. number | | ean code | | art. number | | ean code |
|-----|-------------------|---|-----------------|-----|-------------------|---|-----------------|
| 150 | 34 439 039 150 00 | 1 | 8 711904 222895 | 425 | 34 439 039 425 00 | 1 | 8 711904 222925 |

| description | | | | | | | additional information |
|---------------------------|-------------|------|------|------|---|---|------------------------|
| pure soft brick wheels 50 | 49.0 x 49.0 | 49.0 | 46.0 | 7.24 | 1 | 8 | |

| | art. number | | ean code | | art. number | | ean code |
|-----|-------------------|---|-----------------|-----|-------------------|---|-----------------|
| 150 | 34 449 049 150 00 | 1 | 8 711904 223007 | 425 | 34 449 049 425 00 | 1 | 8 711904 223021 |

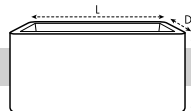

PURE SOFT BRICK LONG

size = L x D, height = H



| description | | | | | | | additional information |
|--------------------------------|-------------|------|------|------|---|---|------------------------|
| pure soft brick long wheels 80 | 79.0 x 39.0 | 39.0 | 56.0 | 7.17 | 1 | 9 | |

| | art. number | | ean code | | art. number | | ean code |
|-----|-------------------|---|-----------------|-----|-------------------|---|-----------------|
| 150 | 34 839 079 150 00 | 1 | 8 711904 229924 | 425 | 34 839 079 425 00 | 1 | 8 711904 229948 |

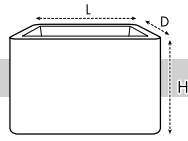

PURE SOFT BRICK DIVIDER

size = L x D, height = H



| description | | | | | | | additional information |
|-----------------------------------|-------------|------|------|------|---|---|------------------------|
| pure soft brick divider wheels 80 | 79.0 x 29.5 | 59.0 | 37.0 | 9.88 | 1 | 8 | |

| | art. number | | ean code | | art. number | | ean code |
|-----|-------------------|---|----------|-----|-------------------|---|----------|
| 150 | 34 659 079 150 00 | 1 | | 425 | 34 659 079 425 00 | 1 | |

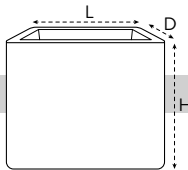

PURE SOFT BRICK DIVIDER LARGE

size = L x D, height = H



| description | | | | | | | additional information |
|-----------------------------------------|-------------|------|------|------|---|---|------------------------|
| pure soft brick divider wheels 80 large | 79.0 x 39.5 | 65.0 | 65.0 | 9.59 | 1 | 6 | |

| | art. number | | ean code | | art. number | | ean code |
|-----|-------------------|---|----------|-----|-------------------|---|----------|
| 150 | 34 665 079 150 00 | 1 | | 425 | 34 665 079 425 00 | 1 | |

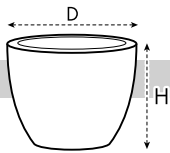

PURE SOFT ROUND

size = L x D, height = H



| description | | | | | | | additional information |
|--------------------|------|------|------|------|---|-----|------------------------|
| pure soft round 30 | 29.0 | 23.0 | 10.0 | 0.68 | 1 | 110 | |

| | art. number | | ean code | | art. number | | ean code |
|-----|-------------------|---|----------|-----|-------------------|---|----------|
| 150 | 88 723 729 150 00 | 1 | | 425 | 88 723 729 425 00 | 1 | |

| description | | | | | | | additional information |
|---------------------------|------|------|------|------|---|----|------------------------|
| pure soft round wheels 40 | 39.0 | 30.5 | 25.0 | 1.35 | 1 | 48 | |

| | art. number | | ean code | | art. number | | ean code |
|-----|-------------------|---|----------|-----|-------------------|---|----------|
| 150 | 88 730 739 150 00 | 1 | | 425 | 88 730 739 425 00 | 1 | |

| description | ∅ | ∇ | Ltr | Kg | 📦 | 📦 | additional information |
|---------------------------|------|------|------|------|---|----|------------------------|
| pure soft round wheels 50 | 49.0 | 37.0 | 47.0 | 2.35 | 1 | 21 | |

| art. number | ean code | art. number | ean code |
|-------------------------|-----------------|-------------------------|-----------------|
| 150 88 737 749 150 00 1 | 8 711904 142599 | 425 88 737 749 425 00 1 | 8 711904 138967 |

| description | ∅ | ∇ | Ltr | Kg | 📦 | 📦 | additional information |
|---------------------------|------|------|------|------|---|----|------------------------|
| pure soft round wheels 60 | 59.0 | 44.5 | 82.0 | 3.54 | 1 | 12 | |

| art. number | ean code | art. number | ean code |
|-------------------------|-----------------|-------------------------|-----------------|
| 150 88 745 759 150 00 1 | 8 711904 142612 | 425 88 745 759 425 00 1 | 8 711904 139001 |

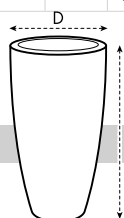

PURE SOFT ROUND HIGH

size = L x D, height = H



| description | ∅ | ∇ | Ltr | Kg | 📦 | 📦 | additional information |
|-------------------------|------|------|-----|------|---|----|------------------------|
| pure soft round high 30 | 29.5 | 52.5 | 9.0 | 2.15 | 1 | 44 | |

| art. number | ean code | art. number | ean code |
|-------------------------|-----------------|-------------------------|-----------------|
| 150 88 853 730 150 00 1 | 8 711904 151607 | 425 88 853 730 425 00 1 | 8 711904 151621 |

| description | ∅ | ∇ | Ltr | Kg | 📦 | 📦 | additional information |
|-------------------------|------|------|------|------|---|----|------------------------|
| pure soft round high 35 | 34.5 | 61.5 | 14.5 | 2.55 | 1 | 24 | |

| art. number | ean code | art. number | ean code |
|-------------------------|-----------------|-------------------------|-----------------|
| 150 88 862 735 150 00 1 | 8 711904 151645 | 425 88 862 735 425 00 1 | 8 711904 151669 |



| description | | | | | | | additional information |
|-------------------------|------|------|------|------|---|----|------------------------|
| pure soft round high 40 | 39.0 | 70.1 | 20.0 | 3.43 | 1 | 24 | |

| | art. number | | ean code | | art. number | | ean code |
|--|-------------------|---|----------|--|-------------------|---|----------|
| | 88 870 739 150 00 | 1 | | | 88 870 739 425 00 | 1 | |

| description | | | | | | | additional information |
|-------------------------|------|------|------|------|---|---|------------------------|
| pure soft round high 50 | 48.5 | 88.5 | 38.0 | 6.51 | 1 | 9 | |

| | art. number | | ean code | | art. number | | ean code |
|--|-------------------|---|----------|--|-------------------|---|----------|
| | 88 890 749 150 00 | 1 | | | 88 890 749 425 00 | 1 | |

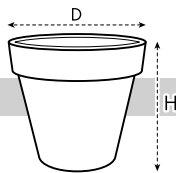

PURE ROUND
size = L x D, height = H



| description | | | | | | | additional information |
|---------------|------|------|------|------|---|-----|------------------------|
| pure round 40 | 39.0 | 35.7 | 22.0 | 1.40 | 1 | 120 | |

| | art. number | | ean code | | art. number | | ean code | | art. number | | ean code |
|--|-------------------|---|----------|--|-------------------|---|----------|--|-------------------|---|----------|
| | 84 036 040 118 00 | 1 | | | 84 036 040 150 00 | 1 | | | 84 036 040 425 00 | 1 | |

| description | | | | | | | additional information |
|---------------|------|------|------|------|---|----|------------------------|
| pure round 50 | 49.0 | 44.4 | 44.0 | 2.33 | 1 | 45 | |

| | art. number | | ean code | | art. number | | ean code | | art. number | | ean code |
|--|-------------------|---|----------|--|-------------------|---|----------|--|-------------------|---|----------|
| | 84 045 050 118 00 | 1 | | | 84 045 050 150 00 | 1 | | | 84 045 050 425 00 | 1 | |

| description | | | | | | | additional information |
|---------------|------|------|------|------|---|----|------------------------|
| pure round 60 | 59.0 | 53.6 | 78.0 | 3.75 | 1 | 24 | |

| | art. number | | ean code | | art. number | | ean code | | art. number | | ean code |
|--|-------------------|---|----------|--|-------------------|---|----------|--|-------------------|---|----------|
| | 84 054 060 118 00 | 1 | | | 84 054 060 150 00 | 1 | | | 84 054 060 425 00 | 1 | |

| description | | | | | | | additional information |
|---------------|------|------|-------|------|---|---|------------------------|
| pure round 80 | 76.5 | 70.0 | 180.0 | 7.71 | 1 | 8 | |

| | art. number | | ean code | | art. number | | ean code |
|--|-------------------|---|----------|--|-------------------|---|----------|
| | 84 071 080 150 00 | 1 | | | 84 071 080 425 00 | 1 | |

| description | | | | | | | additional information |
|----------------|------|------|-------|-------|---|---|------------------------|
| pure round 100 | 96.5 | 89.0 | 360.0 | 16.24 | 1 | 5 | |

| | art. number | | ean code | | art. number | | ean code |
|--|-------------------|---|----------|--|-------------------|---|----------|
| | 84 089 100 150 00 | 1 | | | 84 089 100 425 00 | 1 | |

| description | | | | | | | additional information |
|----------------|-------|-------|-------|-------|---|---|------------------------|
| pure round 120 | 116.0 | 106.5 | 625.0 | 21.88 | 1 | 4 | |

| | art. number | | ean code | | art. number | | ean code |
|--|-------------------|---|----------|--|-------------------|---|----------|
| | 84 107 120 150 00 | 1 | | | 84 107 120 425 00 | 1 | |

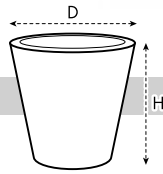

PURE STRAIGHT ROUND

size = L x D, height = H



| description | | | | | | | additional information |
|------------------------|------|------|------|------|---|----|------------------------|
| pure straight round 35 | 34.5 | 33.0 | 21.0 | 1.12 | 1 | 32 | Ø33 |

| | art. number | | ean code | | art. number | | ean code |
|-----|-------------------|---|----------|-----|-------------------|---|----------|
| 150 | 33 233 035 150 00 | 1 | | 425 | 33 233 035 425 00 | 1 | |

| description | | | | | | | additional information |
|------------------------|------|------|------|------|---|----|------------------------|
| pure straight round 50 | 49.5 | 50.5 | 68.0 | 2.57 | 1 | 12 | Ø40 |

| | art. number | | ean code | | art. number | | ean code |
|-----|-------------------|---|----------|-----|-------------------|---|----------|
| 150 | 33 251 050 150 00 | 1 | | 425 | 33 251 050 425 00 | 1 | |

| description | | | | | | | additional information |
|------------------------|------|------|-------|------|---|---|------------------------|
| pure straight round 65 | 64.0 | 68.0 | 157.0 | 4.88 | 1 | 6 | Ø55 |

| | art. number | | ean code | | art. number | | ean code |
|-----|-------------------|---|----------|-----|-------------------|---|----------|
| 150 | 33 268 065 150 00 | 1 | | 425 | 33 268 065 425 00 | 1 | |

| description | | | | | | | additional information |
|------------------------|------|------|-------|------|---|---|------------------------|
| pure straight round 80 | 78.5 | 85.0 | 300.0 | 8.62 | 1 | 4 | |

| | art. number | | ean code | | art. number | | ean code |
|-----|-------------------|---|----------|-----|-------------------|---|----------|
| 150 | 33 286 080 150 00 | 1 | | 425 | 33 286 080 425 00 | 1 | |

pure



PURE STRAIGHT ROUND HIGH

size = L x D, height = H



| description | Ø | cm | Ltr | Kg | art. number | stack | additional information |
|-----------------------------|------|------|------|------|-------------|-------|------------------------|
| pure straight round high 40 | 38.5 | 79.0 | 20.0 | 3.52 | 1 | 18 | Ø33 |

| art. number | ean code | art. number | ean code |
|-----------------------|----------|-----------------------|----------|
| 150 33 108 139 150 00 | | 425 33 108 139 425 00 | |

| description | Ø | cm | Ltr | Kg | art. number | stack | additional information |
|-----------------------------|------|-------|------|------|-------------|-------|------------------------|
| pure straight round high 50 | 49.5 | 102.0 | 41.0 | 6.10 | 1 | 6 | Ø40 |

| art. number | ean code | art. number | ean code |
|-----------------------|----------|-----------------------|----------|
| 150 33 110 150 150 00 | | 425 33 110 150 425 00 | |

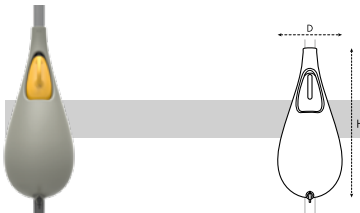

PURE RAINDROP

size = L x D, height = H

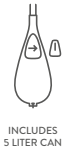
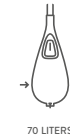

| description | Ø | cm | Ltr | Kg | art. number | stack | additional information |
|---------------|------|-------|------|------|-------------|-------|------------------------|
| pure raindrop | 48.0 | 114.5 | 70.0 | 6.79 | 1 | 3 | |

| art. number | ean code |
|-----------------------|----------|
| 118 00 548 115 118 00 | |

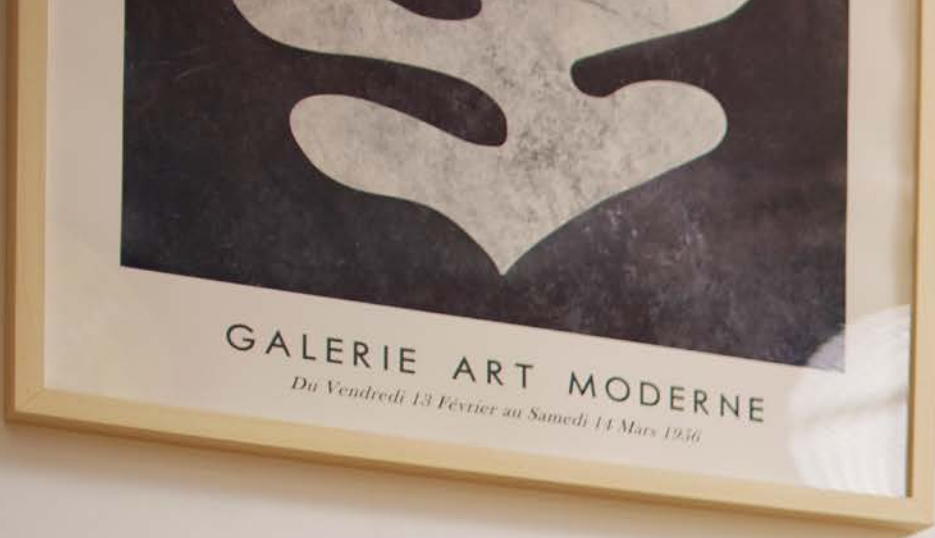

A photograph of a living room interior featuring several indoor plants. A large, light-colored, ribbed ceramic pot holds a tall plant with large, dark green, heart-shaped leaves. To its left, a wooden side table holds three smaller plants in yellow, orange, and blue ribbed pots. Below the plants on the table is a stack of four books. The background shows a window with white horizontal blinds and a portion of a beige sofa. The overall aesthetic is modern and minimalist.

indoor

COLLECTION



THE OCEAN COLLECTION

The pots from the ocean collection are made with maritime plastic, such as fishing nets, ropes and trawls. Our oceans are getting more polluted by this plastic ending up in our precious oceans. By using this waste in our pots, we help preventing this. The origins of the discarded ropes and fishing nets are presented in the blue and green marble accents. Admiring the beauty of our oceans and truly showing the beauty of waste.



NICE THINGS TO KNOW ABOUT THE FAMILY



EASY INNER POT FIT



MADE OUT OF RECYCLED PLASTICS



LIGHT WEIGHT



LONG-LASTING COLOUR



INNOVATION

Ever changing colour tones, so every product is unique!



WATCH THE OCEAN COLLECTION PRODUCT VIDEO

colours

283

572

the ocean collection COLLECTION

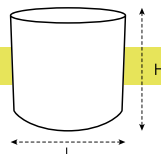

THE OCEAN COLLECTION ROUND

size = L x D, height = H

NEW



EASY INNER
POT FIT

| description | | | | | | | additional information |
|---------------------------------|------|------|-----|------|---|-----|------------------------|
| the ocean collection round 14cm | 13.8 | 12.5 | 1.6 | 0.14 | 8 | 536 | |

| | art. number | | ean code | | art. number | | ean code |
|-----|-------------------|---|----------|-----|-------------------|---|----------|
| 283 | 21 212 014 283 00 | 8 | | 572 | 21 212 014 572 00 | 8 | |

| description | | | | | | | additional information |
|---------------------------------|------|------|-----|------|---|-----|------------------------|
| the ocean collection round 16cm | 16.0 | 15.0 | 2.5 | 0.20 | 8 | 336 | |

| | art. number | | ean code | | art. number | | ean code |
|-----|-------------------|---|----------|-----|-------------------|---|----------|
| 283 | 21 215 016 283 00 | 8 | | 572 | 21 215 016 572 00 | 8 | |

| description | | | | | | | additional information |
|---------------------------------|------|------|-----|------|---|-----|-------------------------------------|
| the ocean collection round 18cm | 18.3 | 16.7 | 3.7 | 0.27 | 6 | 144 | match with self-watering insert Ø17 |

| | art. number | | ean code | | art. number | | ean code |
|-----|-------------------|---|----------|-----|-------------------|---|----------|
| 283 | 21 216 018 283 00 | 6 | | 572 | 21 216 018 572 00 | 6 | |

| description | | | | | | | additional information |
|---------------------------------|------|------|-----|------|---|----|-------------------------------------|
| the ocean collection round 22cm | 22.3 | 20.4 | 6.9 | 0.41 | 5 | 80 | match with self-watering insert Ø21 |

| | art. number | | ean code | | art. number | | ean code |
|-----|-------------------|---|----------|-----|-------------------|---|----------|
| 283 | 21 221 022 283 00 | 5 | | 572 | 21 221 022 572 00 | 5 | |

the ocean collection

INSTORE PRESENTATIONS



THE OCEAN COLLECTION FLOOR STAND

NEW



• to inspire & activate your shopper, order a complete stand with content:

1 metal frame + 2 content = complete concept

1 METAL FRAME STAND (EMPTY)

| art. number | description | size lxd | h | m ² | | ean code |
|-------------------|----------------------------------|----------|-----|----------------|---|-----------------|
| 21 200 023 150 50 | the ocean collection floor stand | 80 x 53 | 198 | 0.42 | 1 | 8 711904 523633 |

2 PRODUCTS (CONTENT FOR STAND)

| art. number | product | | qty. | | qty. | ean code |
|-------------------|---------------------------------|-----|------|-----|------|-----------------|
| 21 200 023 901 10 | the ocean collection round 14cm | 283 | 16 | 572 | 24 | 8 711904 523640 |
| | the ocean collection round 16cm | 283 | 16 | 572 | 16 | |
| | the ocean collection round 18cm | 283 | 12 | 572 | 18 | |



THE OCEAN COLLECTION OCTAGON DISPLAY

NEW

EXCL. CONTENT



• introduce this unique new family to your shopper: display is without content, so order

1 octagon display + 2 content = complete concept

1 OCTAGON DISPLAY (EMPTY)

| art. number | description | size lxd | h | m ² | | ean code |
|-------------------|--------------------------------------|----------|-----|----------------|---|-----------------|
| 21 200 023 150 60 | the ocean collection octagon display | 55 x 55 | 200 | 0.3 | 1 | 8 711904 524012 |

2 PRODUCTS (CONTENT FOR STAND)

| art. number | product | | qty. | | qty. | ean code |
|-------------------|---------------------------------|-----|------|-----|------|-----------------|
| 21 200 023 902 10 | the ocean collection round 14cm | 283 | 8 | 572 | 16 | 8 711904 523893 |
| | the ocean collection round 16cm | 283 | 8 | 572 | 8 | |
| | the ocean collection round 18cm | 283 | 12 | 572 | 12 | |



GALERIE ART MODERNE
The Yearbook of Artwork at Artists of New York

The Hitchcock Book of Home Letters
THE HINTERLAND
SCANDINAVIA DREAMING
THE GREAT WORKS OF

VIBES FOLD

The indoor vibes family fits perfectly into a cozy, harmonious, fashionable and friendly interior. The pots will bring out the best in your indoor plants with its slightly rounded body, soft tones and decorative pattern. A nice way to mix & match different shapes, sizes and on-trend colours.

NICE THINGS TO KNOW ABOUT THE FAMILY

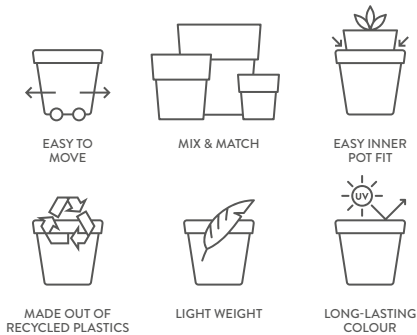

round mini



round



coupe

NEW COLOUR



sorbet green

colours

120

181

294

369

451

new

vibes fold COLLECTION

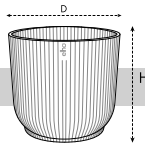

VIBES FOLD ROUND MINI

size = L x D, height = H

NEW
COLOUR



EASY INNER
POT FIT

| description | | | | | | | additional information |
|---------------------------|-----|-----|-----|------|----|------|------------------------|
| vibes fold round mini 7cm | 7.0 | 6.5 | 0.2 | 0.03 | 12 | 4056 | |

| | art. number | | ean code | | art. number | | ean code | | art. number | | ean code |
|--|-------------------|----|---------------------|--|-------------------|----|----------------------|--|-------------------|----|---------------------|
| | 28 165 007 120 00 | 12 | 8 711904 493776 | | 28 165 007 294 00 | 12 | 8 711904 493745 | | 28 165 007 451 00 | 12 | 8 711904 493714 |
| | 28 165 007 181 00 | 12 | 8 711904 493684 | | 28 165 007 369 00 | 12 | 8 711904 4517632 | | | | |

| description | | | | | | | additional information |
|---------------------------|-----|-----|-----|------|---|------|------------------------|
| vibes fold round mini 9cm | 9.3 | 8.8 | 0.5 | 0.06 | 8 | 1920 | |

| | art. number | | ean code | | art. number | | ean code | | art. number | | ean code |
|--|-------------------|---|---------------------|--|-------------------|---|----------------------|--|-------------------|---|---------------------|
| | 28 287 009 120 00 | 8 | 8 711904 494070 | | 28 287 009 294 00 | 8 | 8 711904 494049 | | 28 287 009 451 00 | 8 | 8 711904 494018 |
| | 28 287 009 181 00 | 8 | 8 711904 493981 | | 28 287 009 369 00 | 8 | 8 711904 4517663 | | | | |

| description | | | | | | | additional information |
|----------------------------|------|------|-----|------|---|------|------------------------|
| vibes fold round mini 11cm | 11.1 | 10.5 | 0.8 | 0.10 | 8 | 1664 | |

| | art. number | | ean code | | art. number | | ean code | | art. number | | ean code |
|--|-------------------|---|---------------------|--|-------------------|---|----------------------|--|-------------------|---|---------------------|
| | 28 310 011 120 00 | 8 | 8 711904 494193 | | 28 310 011 294 00 | 8 | 8 711904 494162 | | 28 310 011 451 00 | 8 | 8 711904 494131 |
| | 28 310 011 181 00 | 8 | 8 711904 494100 | | 28 310 011 369 00 | 8 | 8 711904 4517694 | | | | |

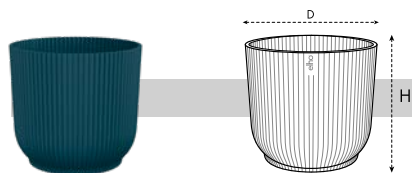

VIBES FOLD ROUND

size = L x D, height = H

NEW COLOUR



| description | Ø | h | Ltr | Kg | boxes | units | additional information |
|-----------------------|------|------|-----|------|-------|-------|------------------------|
| vibes fold round 14cm | 14.1 | 12.9 | 1.6 | 0.16 | 8 | 536 | |

| art. number | boxes | ean code | art. number | boxes | ean code | art. number | boxes | ean code |
|-----------------------|-------|----------|-----------------------|-------|----------|-----------------------|-------|----------|
| 120 25 013 014 120 00 | 8 | | 294 25 013 014 294 00 | 8 | | 451 25 013 014 451 00 | 8 | |
| 181 25 013 014 181 00 | 8 | | 369 25 013 014 369 00 | 8 | | | | |

| description | Ø | h | Ltr | Kg | boxes | units | additional information |
|-----------------------|------|------|-----|------|-------|-------|------------------------|
| vibes fold round 16cm | 16.1 | 14.8 | 2.4 | 0.22 | 8 | 288 | |

| art. number | boxes | ean code | art. number | boxes | ean code | art. number | boxes | ean code |
|-----------------------|-------|----------|-----------------------|-------|----------|-----------------------|-------|----------|
| 120 25 415 016 120 00 | 8 | | 294 25 415 016 294 00 | 8 | | 451 25 415 016 451 00 | 8 | |
| 181 25 415 016 181 00 | 8 | | 369 25 415 016 369 00 | 8 | | | | |

| description | Ø | h | Ltr | Kg | boxes | units | additional information |
|-----------------------|------|------|-----|------|-------|-------|-------------------------------------|
| vibes fold round 18cm | 18.3 | 16.8 | 3.6 | 0.29 | 6 | 144 | match with self-watering insert Ø17 |

| art. number | boxes | ean code | art. number | boxes | ean code | art. number | boxes | ean code |
|-----------------------|-------|----------|-----------------------|-------|----------|-----------------------|-------|----------|
| 120 26 417 018 120 00 | 6 | | 294 26 417 018 294 00 | 6 | | 451 26 417 018 451 00 | 6 | |
| 181 26 417 018 181 00 | 6 | | 369 26 417 018 369 00 | 6 | | | | |

| description | Ø | h | Ltr | Kg | boxes | units | additional information |
|-----------------------|------|------|-----|------|-------|-------|-------------------------------------|
| vibes fold round 22cm | 22.0 | 20.2 | 6.2 | 0.44 | 5 | 80 | match with self-watering insert Ø21 |

| art. number | boxes | ean code | art. number | boxes | ean code | art. number | boxes | ean code |
|-----------------------|-------|----------|-----------------------|-------|----------|-----------------------|-------|----------|
| 181 27 120 022 181 00 | 5 | | 294 27 120 022 294 00 | 5 | | 451 27 120 022 451 00 | 5 | |



| description | | | | | | | additional information |
|-----------------------|------|------|-----|------|---|----|-------------------------------------|
| vibes fold round 25cm | 25.0 | 23.0 | 9.2 | 0.62 | 4 | 96 | match with self-watering insert Ø24 |

| | art. number | | ean code | | art. number | | ean code | | art. number | | ean code |
|-----|-------------------|---|----------|-----|-------------------|---|----------|-----|-------------------|---|----------|
| 181 | 28 422 025 181 00 | 4 | | 294 | 28 422 025 294 00 | 4 | | 451 | 28 422 025 451 00 | 4 | |

| description | | | | | | | additional information |
|-----------------------|------|------|------|------|---|----|-------------------------------------|
| vibes fold round 30cm | 29.5 | 27.2 | 15.0 | 0.89 | 1 | 36 | match with self-watering insert Ø28 |

| | art. number | | ean code | | art. number | | ean code | | art. number | | ean code |
|-----|-------------------|---|----------|-----|-------------------|---|----------|-----|-------------------|---|----------|
| 181 | 28 527 030 181 00 | 1 | | 294 | 28 527 030 294 00 | 1 | | 451 | 28 527 030 451 00 | 1 | |

| description | | | | | | | additional information |
|------------------------------|------|------|------|------|---|----|-------------------------------------|
| vibes fold round wheels 35cm | 34.9 | 32.4 | 26.0 | 1.34 | 1 | 24 | match with self-watering insert Ø33 |

| | art. number | | ean code | | art. number | | ean code | | art. number | | ean code |
|-----|-------------------|---|----------|-----|-------------------|---|----------|-----|-------------------|---|----------|
| 181 | 28 932 035 181 00 | 1 | | 294 | 28 932 035 294 00 | 1 | | 451 | 28 932 035 451 00 | 1 | |

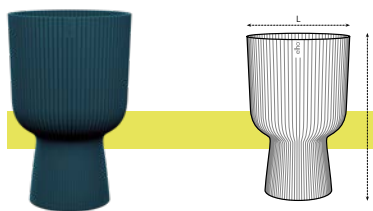

VIBES FOLD COUPE

size = L x D, height = H



| description | | | | | | | additional information |
|-----------------------|-------------|------|-----|------|---|-----|------------------------|
| vibes fold coupe 14cm | 13.9 x 13.9 | 21.0 | 1.7 | 0.21 | 4 | 256 | |

| | art. number | | ean code | | art. number | | ean code | | art. number | | ean code |
|-----|-------------------|---|----------|-----|-------------------|---|----------|-----|-------------------|---|----------|
| 181 | 29 021 014 181 00 | 4 | | 294 | 29 021 014 294 00 | 4 | | 451 | 29 021 014 451 00 | 4 | |

vibes fold INSTORE PRESENTATIONS



VIBES MINI UNIVERSAL ROUND TABLE STAND

- to inspire & activate your shopper, order a complete stand with content:

1 metal frame + 2 content = complete concept



1 METAL FRAME STAND (EMPTY)

| art. number | description | size lxd | h | m ² | | ean code |
|-------------------|----------------------------------------|----------|-----|----------------|---|-----------------|
| 25 000 001 000 50 | vibes mini universal round table stand | 56 x 56 | 130 | 0.31 | 1 | 8 711904 509231 |

2 PRODUCTS (CONTENT FOR STAND)

| art. number | product | | qty. | | qty. | | qty. | | qty. | ean code |
|-------------------|----------------------------|-----|------|-----|------|-----|------|-----|------|-----------------|
| 28 000 004 901 10 | vibes fold round mini 7cm | 120 | 12 | 181 | 12 | 294 | 24 | 451 | 12 | 8 711904 509286 |
| | vibes fold round mini 9cm | 120 | 16 | 181 | 24 | 294 | 24 | 451 | 24 | |
| | vibes fold round mini 11cm | 120 | 16 | 181 | 16 | 294 | 16 | 451 | 16 | |



VIBES FOLD ROUND MINI DISPLAY

- create awareness, ideal second placement for cross-selling on plant table

NEW COLOUR



| art. number | size lxd | | m ² | product | | qty. | | qty. | | qty. | | qty. | ean code |
|-------------------|----------|----|----------------|---------------------------|-----|------|-----|------|-----|------|-----|------|-----------------|
| 28 000 001 901 10 | 25 x 23 | 25 | 0.06 | vibes fold round mini 7cm | 120 | 9 | 181 | 9 | 294 | 9 | 451 | 9 | 8 711904 509255 |

| art. number | size lxd | | m ² | product | | qty. | | qty. | | qty. | | qty. | ean code |
|-------------------|----------|----|----------------|---------------------------|-----|------|-----|------|-----|------|-----|------|-----------------|
| 28 000 001 902 10 | 25 x 23 | 25 | 0.06 | vibes fold round mini 7cm | 181 | 9 | 294 | 9 | 369 | 9 | 451 | 9 | 8 711904 524180 |

| art. number | size lxd | | m ² | product | | qty. | | qty. | | qty. | | qty. | ean code |
|-------------------|----------|----|----------------|---------------------------|-----|------|-----|------|-----|------|-----|------|-----------------|
| 28 000 002 901 10 | 25 x 23 | 25 | 0.06 | vibes fold round mini 9cm | 120 | 3 | 181 | 4 | 294 | 4 | 451 | 4 | 8 711904 509262 |

| art. number | size lxd | | m ² | product | | qty. | | qty. | | qty. | | qty. | ean code |
|-------------------|----------|----|----------------|---------------------------|-----|------|-----|------|-----|------|-----|------|-----------------|
| 28 000 002 902 10 | 25 x 23 | 25 | 0.06 | vibes fold round mini 9cm | 181 | 3 | 294 | 4 | 369 | 4 | 451 | 4 | 8 711904 524197 |



VIBES INSPIRATIONAL SHELF

- create awareness: attract attention to the shelf and seduce your shopper to buy these unique new indoor pots

EXCL. CONTENT



| art. number | description | size lxd | h | m ² | | ean code |
|-------------------|---------------------------------|----------|-----|----------------|---|-----------------|
| 25 000 001 901 50 | vibes inspirational metal shelf | 100 x 56 | 7.5 | 0.56 | 1 | 8 711904 485665 |



VIBES OCTAGON DISPLAY

- to inspire & activate your shopper, order a display and content:

1 octagon display + 2 content = complete concept

- display is delivered flat-packed excl. content, please order advised quantity for complete presentation

NEW COLOUR

EXCL. CONTENT



1 OCTAGON DISPLAY (EMPTY)

| art. number | description | size lxd | h | m ² | | ean code |
|-------------------|------------------------------|----------|-----|----------------|---|-----------------|
| 25 000 001 902 50 | vibes octagon carton display | 55 x 55 | 200 | 0.3 | 1 | 8 711904 485788 |

2 PRODUCTS (CONTENT FOR STAND)

| art. number | product | | qty. | | qty. | | qty. | | qty. | ean code |
|-------------------|-----------------------|-----|------|-----|------|-----|------|-----|------|-----------------|
| 25 000 001 901 10 | vibes fold round 14cm | 120 | 8 | 181 | 8 | 294 | 8 | 451 | 8 | 8 711904 485160 |
| | vibes fold round 16cm | 120 | 8 | 181 | 8 | 294 | 8 | 451 | 8 | |
| | vibes fold round 18cm | 120 | 6 | 181 | 6 | 294 | 6 | 451 | 6 | |



| art. number | product | | qty. | | qty. | | qty. | | qty. | ean code |
|-------------------|-----------------------|-----|------|-----|------|-----|------|-----|------|------------------|
| 25 000 001 904 10 | vibes fold round 14cm | 181 | 8 | 294 | 8 | 369 | 8 | 451 | 8 | 8 711904 1524203 |
| | vibes fold round 16cm | 181 | 8 | 294 | 8 | 369 | 8 | 451 | 8 | |
| | vibes fold round 18cm | 181 | 6 | 294 | 6 | 369 | 6 | 451 | 6 | |

VIBES OCTAGON FLOOR STAND
**NEW
COLOUR**







• to inspire & activate your shopper, order a complete stand with content:





1 metal frame + **2** content = complete concept

1 METAL FRAME STAND (EMPTY)

| art. number | description | size lxd | h | m ² |  | ean code |
|------------------|---------------------------|----------|-----|----------------|-------------------------------------------------------------------------------------|--------------------------------------------------------------------------------------------------------|
| 25 000 001150 50 | vibes octagon metal stand | 55 x 55 | 222 | 0.3 | 1 |  8 711904 485672 |

2 PRODUCTS (CONTENT FOR STAND)

| art. number | product |  | qty. |  | qty. |  | qty. |  | qty. | ean code |
|------------------|-----------------------|-----------------------------------------------------------------------------------|------|-------------------------------------------------------------------------------------|------|-------------------------------------------------------------------------------------|------|-------------------------------------------------------------------------------------|------|--------------------------------------------------------------------------------------------------------|
| 25 000 001901 10 | vibes fold round 14cm | 120 | 8 | 181 | 8 | 294 | 8 | 451 | 8 |  8 711904 485160 |
| | vibes fold round 16cm | 120 | 8 | 181 | 8 | 294 | 8 | 451 | 8 | |
| | vibes fold round 18cm | 120 | 6 | 181 | 6 | 294 | 6 | 451 | 6 | |

| art. number | product |  | qty. |  | qty. |  | qty. |  | qty. | ean code |
|------------------|-----------------------|-------------------------------------------------------------------------------------|------|---------------------------------------------------------------------------------------|------|---------------------------------------------------------------------------------------|------|---------------------------------------------------------------------------------------|------|----------------------------------------------------------------------------------------------------------|
| 25 000 001904 10 | vibes fold round 14cm | 181 | 8 | 294 | 8 | 369 | 8 | 451 | 8 |  8 711904 524203 |
| | vibes fold round 16cm | 181 | 8 | 294 | 8 | 369 | 8 | 451 | 8 | |
| | vibes fold round 18cm | 181 | 6 | 294 | 6 | 369 | 6 | 451 | 6 | |



B.FOR SOFT

b.for soft is a beautiful addition to your modern interior. With its soft shapes and colours, these clean round shapes will bring you many joy. In particular, b.for soft allows vertically growing by introducing the b.for swing. Green up your home, by combining different sizes and shapes; mix & match!



NICE THINGS TO KNOW ABOUT THE FAMILY



EASY INNER POT FIT

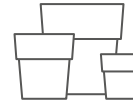

MIX & MATCH



MADE OUT OF RECYCLED PLASTICS



LIGHT WEIGHT



LONG-LASTING COLOUR



swing



round



duo



air



colours

150

181

360

367

425

762

new

INNOVATION



b.for swing

new unique hanging design
self-watering insert fits perfectly
mix & match

b.for soft COLLECTION

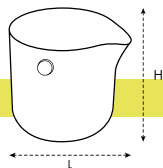

B.FOR SWING

size = L x D, height = H

NEW



EASY INNER POT FIT

| description | | | | | | | additional information |
|------------------|------|------|-----|------|---|------|-------------------------------------|
| b.for swing 18cm | 18.0 | 16.5 | 3.5 | 0.29 | 8 | 640* | match with self-watering insert Ø17 |

| | art. number | | ean code | | art. number | | ean code | | art. number | | ean code |
|--|-------------------|---|----------|--|-------------------|---|----------|--|-------------------|---|----------|
| | 42 816 018 150 00 | 8 | | | 42 816 018 360 00 | 8 | | | 42 816 018 425 00 | 8 | |
| | 42 816 018 181 00 | 8 | | | 42 816 018 367 00 | 8 | | | 42 816 018 762 00 | 8 | |

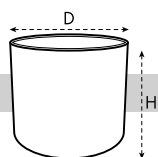

B.FOR SOFT ROUND

size = L x D, height = H



EASY INNER POT FIT

| description | | | | | | | additional information |
|-----------------------|------|------|-----|------|---|-----|------------------------|
| b.for soft round 14cm | 13.8 | 12.5 | 1.6 | 0.14 | 8 | 536 | |

| | art. number | | ean code | | art. number | | ean code | | art. number | | ean code |
|--|-------------------|---|----------|--|-------------------|---|----------|--|-------------------|---|----------|
| | 41 212 014 150 00 | 8 | | | 41 212 014 360 00 | 8 | | | 41 212 014 762 00 | 8 | |
| | 41 212 014 181 00 | 8 | | | 41 212 014 425 00 | 8 | | | | | |

| description | | | | | | | additional information |
|-----------------------|------|------|-----|------|---|-----|------------------------|
| b.for soft round 16cm | 16.0 | 15.0 | 2.5 | 0.20 | 8 | 336 | |

| | art. number | | ean code | | art. number | | ean code | | art. number | | ean code |
|--|-------------------|---|----------|--|-------------------|---|----------|--|-------------------|---|----------|
| | 41 214 016 150 00 | 8 | | | 41 214 016 360 00 | 8 | | | 41 214 016 762 00 | 8 | |
| | 41 214 016 181 00 | 8 | | | 41 214 016 425 00 | 8 | | | | | |

| description | | ∅ | ↓ | Ltr | Kg | ☰ | ☰ | additional information |
|-----------------------|--|------|------|-----|------|---|-----|-------------------------------------|
| b.for soft round 18cm | | 18.3 | 16.7 | 3.7 | 0.27 | 6 | 144 | match with self-watering insert Ø17 |

| | art. number | ☰ | ean code | | art. number | ☰ | ean code | | art. number | ☰ | ean code |
|-----|-------------------|---|----------|-----|-------------------|---|----------|-----|-------------------|---|----------|
| 150 | 41 216 018 150 00 | 6 | | 360 | 41 216 018 360 00 | 6 | | 762 | 41 216 018 762 00 | 6 | |
| 181 | 41 216 018 181 00 | 6 | | 425 | 41 216 018 425 00 | 6 | | | | | |

| description | | ∅ | ↓ | Ltr | Kg | ☰ | ☰ | additional information |
|-----------------------|--|------|------|-----|------|---|----|-------------------------------------|
| b.for soft round 22cm | | 22.3 | 20.4 | 6.9 | 0.41 | 5 | 80 | match with self-watering insert Ø21 |

| | art. number | ☰ | ean code | | art. number | ☰ | ean code | | art. number | ☰ | ean code |
|-----|-------------------|---|----------|-----|-------------------|---|----------|-----|-------------------|---|----------|
| 150 | 41 220 022 150 00 | 5 | | 360 | 41 220 022 360 00 | 5 | | 425 | 41 220 022 425 00 | 5 | |

| description | | ∅ | ↓ | Ltr | Kg | ☰ | ☰ | additional information |
|-----------------------|--|------|------|-----|------|---|----|-------------------------------------|
| b.for soft round 25cm | | 24.7 | 23.3 | 9.8 | 0.55 | 4 | 96 | match with self-watering insert Ø24 |

| | art. number | ☰ | ean code | | art. number | ☰ | ean code | | art. number | ☰ | ean code |
|-----|-------------------|---|----------|-----|-------------------|---|----------|-----|-------------------|---|----------|
| 150 | 41 223 025 150 00 | 4 | | 360 | 41 223 025 360 00 | 4 | | 425 | 41 223 025 425 00 | 4 | |

| description | | ∅ | ↓ | Ltr | Kg | ☰ | ☰ | additional information |
|-----------------------|--|------|------|------|------|---|----|-------------------------------------|
| b.for soft round 30cm | | 29.5 | 27.6 | 16.5 | 0.85 | 1 | 36 | match with self-watering insert Ø28 |

| | art. number | ☰ | ean code | | art. number | ☰ | ean code | | art. number | ☰ | ean code |
|-----|-------------------|---|----------|-----|-------------------|---|----------|-----|-------------------|---|----------|
| 150 | 41 228 030 150 00 | 1 | | 360 | 41 228 030 360 00 | 1 | | 425 | 41 228 030 425 00 | 1 | |

| description | | ∅ | ↓ | Ltr | Kg | ☰ | ☰ | additional information |
|-----------------------|--|------|------|------|------|---|----|-------------------------------------|
| b.for soft round 35cm | | 34.5 | 32.3 | 26.5 | 1.18 | 1 | 24 | match with self-watering insert Ø33 |

| | art. number | ☰ | ean code | | art. number | ☰ | ean code | | art. number | ☰ | ean code |
|-----|-------------------|---|----------|-----|-------------------|---|----------|-----|-------------------|---|----------|
| 150 | 41 232 035 150 00 | 1 | | 360 | 41 232 035 360 00 | 1 | | 425 | 41 232 035 425 00 | 1 | |

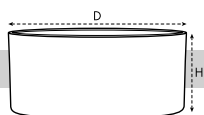

B.FOR SOFT DUO

size = L x D, height = H



EASY INNER
POT FIT

| description | | | | | | | additional information |
|---------------------|-------------|------|-----|------|---|-----|------------------------|
| b.for soft duo 27cm | 27.0 x 13.5 | 12.6 | 3.7 | 0.25 | 6 | 252 | |

| | art. number | | ean code | | art. number | | ean code |
|-----|-------------------|---|-----------------|-----|-------------------|---|-----------------|
| 150 | 41 813 027 150 00 | 6 | 8 711904 302801 | 425 | 41 813 027 425 00 | 6 | 8 711904 302825 |

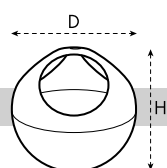

B.FOR SOFT AIR

size = L x D, height = H

| description | | | | | | | additional information |
|----------------|------|------|-----|------|---|-----|------------------------|
| b.for soft air | 18.0 | 17.5 | 1.5 | 0.26 | 4 | 240 | |

| | art. number | | ean code | | art. number | | ean code |
|-----|-------------------|---|-----------------|-----|-------------------|---|-----------------|
| 150 | 41 618 118 150 00 | 4 | 8 711904 249519 | 425 | 41 618 118 425 00 | 4 | 8 711904 249540 |



B.FOR SOFT ROUND

b.for soft INSTORE PRESENTATIONS



B.FOR SWING DEMO SHELF PRESENTATION

- ideal presentation for concept explanation and stimulating the buying impulse

NEW



| art. number | description | size lxd | h | m ² | | ean code |
|-------------------|-------------------------------------|----------|----|----------------|---|------------------|
| 42 000 001 150 10 | b.for swing demo shelf presentation | 12 x 24 | 33 | 0.03 | 1 | 8 711904 1523763 |



B.FOR SOFT ROUND UNIVERSAL FLOOR STAND

- to inspire & activate your shopper, order a complete stand with content:

1 metal frame + 2 content = complete concept



1 METAL FRAME STAND (EMPTY)

| art. number | description | size lxd | h | m ² | | ean code |
|-------------------|------------------------------------|----------|-----|----------------|---|-----------------|
| 19 100 027 150 50 | indoor universal floor stand b.for | 80 x 53 | 198 | 0.42 | 1 | 8 711904 307790 |

2 PRODUCTS (CONTENT FOR STAND)

| art. number | product | | qty. | | qty. | | qty. | ean code |
|-------------------|-----------------------|-----|------|-----|------|-----|------|-----------------|
| 92 000 055 904 10 | b.for soft round 14cm | 150 | 8 | 425 | 8 | 762 | 8 | 8 711904 484729 |
| | b.for soft round 16cm | 150 | 8 | 425 | 8 | 762 | 8 | |
| | b.for soft round 18cm | 150 | 12 | 425 | 6 | 762 | 6 | |
| | b.for soft duo 27cm | 150 | 6 | 425 | 6 | | | |



| art. number | product | | qty. | | qty. | | qty. | ean code |
|-------------------|-----------------------|-----|------|-----|------|-----|------|-----------------|
| 92 000 055 905 10 | b.for soft round 14cm | 150 | 8 | 360 | 8 | 425 | 8 | 8 711904 484736 |
| | b.for soft round 16cm | 150 | 8 | 360 | 8 | 425 | 8 | |
| | b.for soft round 18cm | 150 | 12 | 360 | 6 | 425 | 6 | |
| | b.for soft duo 27cm | 150 | 6 | 425 | 6 | | | |



B.FOR SOFT AIR SHELF PRESENTATION

- ideal for live presentation of b.for soft air



| art. number | description | size lxd | h | m ² |  | ean code |
|-------------------|-----------------------------------|----------|----|----------------|-------------------------------------------------------------------------------------|--------------------------------------------------------------------------------------------------------|
| 41 000 028 425 10 | b.for soft air shelf presentation | 12 x 16 | 33 | 0.04 | 1 |  8 711904 286002 |



B.FOR STUDIO

Stylish, modern and trendy! b.for studio is a qualitative indoor flower pot with stand, designed by Dutch designer duo Daphna Laurans. With b.for studio, you bring a piece of design into your interior. Combine different pot sizes and create a contemporary atmosphere.



NICE THINGS TO KNOW ABOUT THE FAMILY



INCLUDES FRAME

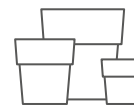

MIX & MATCH



LIGHT WEIGHT



LONG-LASTING COLOUR



round 22cm



round 30cm



bowl

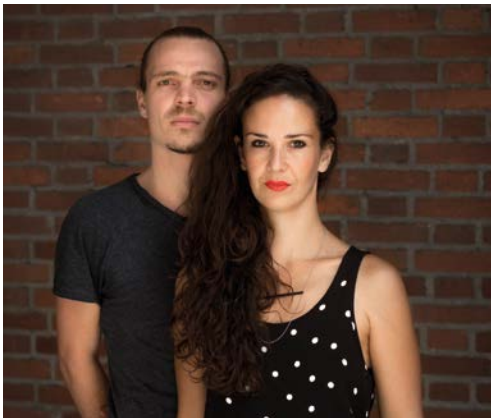

Dutch designer duo Daphna Laurans:

'The b.for studio literally takes your plants to a higher level. The way in which the pot and the stand meet and the unification of the two elements were important to us when designing the collection.'



WATCH THE
B.FOR STUDIO
PRODUCT VIDEO

colours

431

433

701

b.for studio COLLECTION

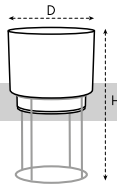

B.FOR STUDIO ROUND

size = L x D, height = H



INCLUDES FRAME

| description | | | | | | | additional information |
|-------------------------|------|------|-----|------|---|-----|-----------------------------------------|
| b.for studio round 22cm | 22.0 | 37.9 | 6.5 | 1.29 | 1 | 105 | height pot: 20.0cm, height rack: 21.9cm |

| | art. number | | ean code | | art. number | | ean code | | art. number | | ean code |
|-----|-------------------|---|----------|-----|-------------------|---|----------|-----|-------------------|---|----------|
| 431 | 08 320 322 431 00 | 1 | | 433 | 08 320 322 433 00 | 1 | | 701 | 08 320 322 701 00 | 1 | |

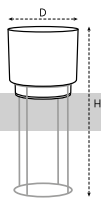

B.FOR STUDIO ROUND

size = L x D, height = H



INCLUDES FRAME

| description | | | | | | | additional information |
|-------------------------|------|------|------|------|---|----|-----------------------------------------|
| b.for studio round 30cm | 29.3 | 68.0 | 15.0 | 2.56 | 1 | 24 | height pot: 27.3cm, height rack: 46.7cm |

| | art. number | | ean code | | art. number | | ean code | | art. number | | ean code |
|-----|-------------------|---|----------|-----|-------------------|---|----------|-----|-------------------|---|----------|
| 431 | 08 427 829 431 00 | 1 | | 433 | 08 427 829 433 00 | 1 | | 701 | 08 427 829 701 00 | 1 | |

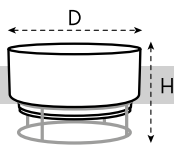

B.FOR STUDIO BOWL

size = L x D, height = H



INCLUDES FRAME

| description | | | | | | | additional information |
|------------------------|------|------|-----|------|---|----|-----------------------------------------|
| b.for studio bowl 30cm | 29.3 | 18.8 | 8.0 | 1.54 | 1 | 90 | height bowl: 13.6cm, height rack: 7.9cm |

| | art. number | | ean code | | art. number | | ean code | | art. number | | ean code |
|-----|-------------------|---|----------|-----|-------------------|---|----------|-----|-------------------|---|----------|
| 431 | 08 513 929 431 00 | 1 | | 433 | 08 513 929 433 00 | 1 | | 701 | 08 513 929 701 00 | 1 | |



B.FOR STUDIO FAMILY



B.FOR ORIGINAL

The b.for original collection makes the most of your indoor plants. Its sturdy design fits right into your industrial interior. In particular, with the combination of a glossy rim and matt body.



NICE THINGS TO KNOW ABOUT THE FAMILY



EASY INNER POT FIT

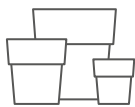

MIX & MATCH



MADE OUT OF RECYCLED PLASTICS



LIGHT WEIGHT



LONG-LASTING COLOUR



round mini



round



colours

118

150

403

433

541

new

NEW COLOUR



dove blue

b.for original COLLECTION

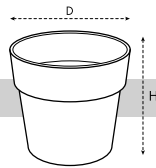

B.FOR ORIGINAL ROUND MINI

size = L x D, height = H



| description | | | | | | | additional information |
|-------------------------------|-----|-----|-----|------|----|------|------------------------|
| b.for original round mini 7cm | 6.6 | 6.0 | 0.1 | 0.02 | 12 | 2496 | |

| | art. number | | ean code | | art. number | | ean code | | art. number | | ean code | | | | | | |
|--|-------------|-------------------|----------|--|-----------------|--|----------|-------------------|-------------|--|-----------------|--|-----|-------------------|----|--|------------------|
| | 118 | 92 613 007 118 00 | 12 | | 8 711904 331214 | | 403 | 92 613 007 403 00 | 12 | | 8 711904 331221 | | 541 | 92 613 007 541 00 | 12 | | 8 711904 1515225 |
| | 150 | 92 613 007 150 00 | 12 | | 8 711904 331207 | | 433 | 92 613 007 433 00 | 12 | | 8 711904 348151 | | | | | | |

| description | | | | | | | additional information |
|-------------------------------|-----|-----|-----|------|---|------|------------------------|
| b.for original round mini 9cm | 9.0 | 8.5 | 0.3 | 0.05 | 8 | 1664 | |

| | art. number | | ean code | | art. number | | ean code | | art. number | | ean code | | | | | | |
|--|-------------|-------------------|----------|--|-----------------|--|----------|-------------------|-------------|--|-----------------|--|-----|-------------------|---|--|------------------|
| | 118 | 92 613 009 118 00 | 8 | | 8 711904 331252 | | 403 | 92 613 009 403 00 | 8 | | 8 711904 331276 | | 541 | 92 613 009 541 00 | 8 | | 8 711904 1515256 |
| | 150 | 92 613 009 150 00 | 8 | | 8 711904 331269 | | 433 | 92 613 009 433 00 | 8 | | 8 711904 348212 | | | | | | |

| description | | | | | | | additional information |
|--------------------------------|------|------|-----|------|---|------|------------------------|
| b.for original round mini 11cm | 11.0 | 10.0 | 0.6 | 0.07 | 8 | 1664 | |

| | art. number | | ean code | | art. number | | ean code | | art. number | | ean code | | | | | | |
|--|-------------|-------------------|----------|--|-----------------|--|----------|-------------------|-------------|--|-----------------|--|-----|-------------------|---|--|------------------|
| | 118 | 92 613 011 118 00 | 8 | | 8 711904 331306 | | 403 | 92 613 011 403 00 | 8 | | 8 711904 331320 | | 541 | 92 613 011 541 00 | 8 | | 8 711904 1515928 |
| | 150 | 92 613 011 150 00 | 8 | | 8 711904 331313 | | 433 | 92 613 011 433 00 | 8 | | 8 711904 348274 | | | | | | |

| description | | | | | | | additional information |
|--------------------------------|------|------|-----|------|---|------|------------------------|
| b.for original round mini 13cm | 12.5 | 12.0 | 1.0 | 0.10 | 8 | 1120 | |

| | art. number | | ean code | | art. number | | ean code | | art. number | | ean code | | | | | | |
|--|-------------|-------------------|----------|--|-----------------|--|----------|-------------------|-------------|--|-----------------|--|-----|-------------------|---|--|------------------|
| | 118 | 92 613 013 118 00 | 8 | | 8 711904 331351 | | 403 | 92 613 013 403 00 | 8 | | 8 711904 331375 | | 541 | 92 613 013 541 00 | 8 | | 8 711904 1515959 |
| | 150 | 92 613 013 150 00 | 8 | | 8 711904 331368 | | 433 | 92 613 013 433 00 | 8 | | 8 711904 348335 | | | | | | |

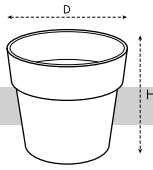

B.FOR ORIGINAL ROUND

size = L x D, height = H



EASY INNER POT FIT

| description | | Ø | ↓ | Ltr | Kg | ☰ | ☰ | additional information |
|---------------------------|--|------|------|-----|------|----|------|------------------------|
| b.for original round 14cm | | 13.7 | 12.5 | 1.3 | 0.12 | 10 | 1400 | |

| | art. number | ☰ | ean code | | art. number | ☰ | ean code | | art. number | ☰ | ean code |
|-----|-------------------|----|----------|-----|-------------------|----|----------|-----|-------------------|----|----------|
| 118 | 92 613 014 118 00 | 10 | | 403 | 92 613 014 403 00 | 10 | | 541 | 92 613 014 541 00 | 10 | |
| 150 | 92 613 014 150 00 | 10 | | 433 | 92 613 014 433 00 | 10 | | | | | |

| description | | Ø | ↓ | Ltr | Kg | ☰ | ☰ | additional information |
|---------------------------|--|------|------|-----|------|----|-----|------------------------|
| b.for original round 16cm | | 15.9 | 14.6 | 2.0 | 0.18 | 10 | 600 | |

| | art. number | ☰ | ean code | | art. number | ☰ | ean code | | art. number | ☰ | ean code |
|-----|-------------------|----|----------|-----|-------------------|----|----------|-----|-------------------|----|----------|
| 118 | 92 615 016 118 00 | 10 | | 403 | 92 615 016 403 00 | 10 | | 541 | 92 615 016 541 00 | 10 | |
| 150 | 92 615 016 150 00 | 10 | | 433 | 92 615 016 433 00 | 10 | | | | | |

| description | | Ø | ↓ | Ltr | Kg | ☰ | ☰ | additional information |
|---------------------------|--|------|------|-----|------|---|-----|-------------------------------------|
| b.for original round 18cm | | 18.0 | 16.5 | 2.9 | 0.24 | 8 | 640 | match with self-watering insert Ø17 |

| | art. number | ☰ | ean code | | art. number | ☰ | ean code | | art. number | ☰ | ean code |
|-----|-------------------|---|----------|-----|-------------------|---|----------|-----|-------------------|---|----------|
| 118 | 92 617 018 118 00 | 8 | | 403 | 92 617 018 403 00 | 8 | | 541 | 92 617 018 541 00 | 8 | |
| 150 | 92 617 018 150 00 | 8 | | 433 | 92 617 018 433 00 | 8 | | | | | |

| description | | Ø | ↓ | Ltr | Kg | ☰ | ☰ | additional information |
|---------------------------|--|------|------|-----|------|---|-----|-------------------------------------|
| b.for original round 22cm | | 22.0 | 20.3 | 5.4 | 0.38 | 6 | 378 | match with self-watering insert Ø21 |

| | art. number | ☰ | ean code | | art. number | ☰ | ean code | | art. number | ☰ | ean code |
|-----|-------------------|---|----------|-----|-------------------|---|----------|-----|-------------------|---|----------|
| 118 | 92 620 022 118 00 | 6 | | 403 | 92 620 022 403 00 | 6 | | 541 | 92 620 022 541 00 | 6 | |
| 150 | 92 620 022 150 00 | 6 | | 433 | 92 620 022 433 00 | 6 | | | | | |



| description | | | | | | | additional information |
|---------------------------|------|------|-----|------|---|-----|-------------------------------------|
| b.for original round 25cm | 24.7 | 23.2 | 7.9 | 0.48 | 4 | 168 | match with self-watering insert Ø24 |

| | art. number | | ean code | | art. number | | ean code | | art. number | | ean code |
|--|-------------------|---|----------|--|-------------------|---|----------|--|-------------------|---|----------|
| | 92 623 025 118 00 | 4 | | | 92 623 025 403 00 | 4 | | | 92 623 025 541 00 | 4 | |
| | 92 623 025 150 00 | 4 | | | 92 623 025 433 00 | 4 | | | | | |

| description | | | | | | | additional information |
|---------------------------|------|------|------|------|---|----|-------------------------------------|
| b.for original round 30cm | 29.5 | 27.3 | 13.1 | 0.69 | 4 | 96 | match with self-watering insert Ø28 |

| | art. number | | ean code | | art. number | | ean code | | art. number | | ean code |
|--|-------------------|---|----------|--|-------------------|---|----------|--|-------------------|---|----------|
| | 92 627 030 118 00 | 4 | | | 92 627 030 403 00 | 4 | | | 92 627 030 541 00 | 4 | |
| | 92 627 030 150 00 | 4 | | | 92 627 030 433 00 | 4 | | | | | |

| description | | | | | | | additional information |
|----------------------------------|------|------|------|------|---|----|-------------------------------------|
| b.for original round wheels 35cm | 35.0 | 32.0 | 21.9 | 1.19 | 1 | 60 | match with self-watering insert Ø33 |

| | art. number | | ean code | | art. number | | ean code | | art. number | | ean code |
|--|-------------------|---|----------|--|-------------------|---|----------|--|-------------------|---|----------|
| | 92 632 035 118 00 | 1 | | | 92 632 035 403 00 | 1 | | | 92 632 035 541 00 | 1 | |
| | 92 632 035 150 00 | 1 | | | 92 632 035 433 00 | 1 | | | | | |

b.for original INSTORE PRESENTATIONS



B.FOR ORIGINAL UNIVERSAL FLOOR STAND

• to inspire & activate your shopper, order a complete stand with content:

1 metal frame + 2 content = complete concept

NEW
COLOUR



1 METAL FRAME STAND (EMPTY)

| art. number | description | size lxd | h | m ² | | ean code |
|-------------------|------------------------------------|----------|-----|----------------|---|-----------------|
| 19 100 027 150 50 | indoor universal floor stand b.for | 80 x 53 | 198 | 0.42 | 1 | 8 711904 307790 |

2 PRODUCTS (CONTENT FOR STAND)

| art. number | product | | qty. | | qty. | | qty. | | qty. | ean code |
|-------------------|---------------------------|-----|------|-----|------|-----|------|-----|------|-----------------|
| 92 000 041 904 10 | b.for original round 14cm | 118 | 20 | 150 | 20 | 403 | 20 | 433 | 10 | 8 711904 508449 |
| | b.for original round 16cm | 118 | 10 | 150 | 10 | 403 | 20 | 433 | 10 | |
| | b.for original round 18cm | 118 | 16 | 150 | 16 | 403 | 16 | 433 | 16 | |

| art. number | product | | qty. | | qty. | | qty. | | qty. | ean code |
|-------------------|---------------------------|-----|------|-----|------|-----|------|-----|------|-----------------|
| 92 000 041 905 10 | b.for original round 14cm | 150 | 20 | 403 | 20 | 433 | 20 | 541 | 10 | 8 711904 523589 |
| | b.for original round 16cm | 150 | 10 | 403 | 10 | 433 | 20 | 541 | 10 | |
| | b.for original round 18cm | 150 | 16 | 403 | 16 | 433 | 16 | 541 | 16 | |



B.FOR ORIGINAL MINI UNIVERSAL ROUND TABLE STAND

NEW
COLOUR



- to inspire & activate your shopper, order a complete stand with content:

1 metal frame + 2 content = complete concept

1 METAL FRAME STAND (EMPTY)

| art. number | description | size lxd | h | m ² | | ean code |
|-------------------|-------------------------------------------------|----------|-----|----------------|---|-----------------|
| 92 000 001 000 50 | b.for original mini universal round table stand | 56 x 56 | 130 | 0.31 | 1 | 8 711904 509293 |

2 PRODUCTS (CONTENT FOR STAND)

| art. number | product | | qty. | | qty. | | qty. | | qty. | ean code |
|-------------------|--------------------------------|-----|------|-----|------|-----|------|-----|------|-----------------|
| 92 000 056 907 10 | b.for original round mini 7cm | 118 | 24 | 150 | 12 | 403 | 12 | 433 | 12 | 8 711904 509361 |
| | b.for original round mini 9cm | 118 | 16 | 150 | 16 | 403 | 16 | 433 | 8 | |
| | b.for original round mini 11cm | 118 | 16 | 150 | 8 | 403 | 8 | 433 | 8 | |
| | b.for original round mini 13cm | 118 | 8 | 150 | 8 | 403 | 8 | 433 | 8 | |

| art. number | product | | qty. | | qty. | | qty. | | qty. | ean code |
|-------------------|--------------------------------|-----|------|-----|------|-----|------|-----|------|-----------------|
| 92 000 056 909 10 | b.for original round mini 7cm | 150 | 24 | 403 | 12 | 433 | 12 | 541 | 12 | 8 711904 523596 |
| | b.for original round mini 9cm | 150 | 16 | 403 | 16 | 433 | 16 | 541 | 8 | |
| | b.for original round mini 11cm | 150 | 16 | 403 | 8 | 433 | 8 | 541 | 8 | |
| | b.for original round mini 13cm | 150 | 8 | 403 | 8 | 433 | 8 | 541 | 8 | |



B.FOR ORIGINAL MINI DISPLAY

NEW
COLOUR



- create awareness, ideal second placement for cross-selling on plant table

| art. number | product | | qty. | | qty. | | qty. | | qty. | | qty. | ean code |
|-------------------|-------------------------------|-----|------|-----|------|-----|------|-----|------|-----|------|-----------------|
| 92 000 066 901 10 | b.for original round mini 7cm | 118 | 20 | 150 | 20 | 403 | 20 | 433 | 20 | 541 | 20 | 8 711904 524166 |

| art. number | size lxd | | m ² | product | | qty. | | qty. | | qty. | | qty. | ean code |
|-------------------|----------|----|----------------|-------------------------------|-----|------|-----|------|-----|------|-----|------|-----------------|
| 92 000 056 906 10 | 25 x 23 | 25 | 0.06 | b.for original round mini 9cm | 118 | 11 | 150 | 10 | 403 | 7 | 433 | 7 | 8 711904 508432 |

| art. number | size lxd | | m ² | product | | qty. | | qty. | | qty. | | qty. | ean code |
|-------------------|----------|----|----------------|-------------------------------|-----|------|-----|------|-----|------|-----|------|-----------------|
| 92 000 096 901 10 | 25 x 23 | 25 | 0.06 | b.for original round mini 9cm | 150 | 11 | 403 | 11 | 433 | 7 | 541 | 7 | 8 711904 524173 |



B.FOR ORIGINAL INDOOR DISPLAY

- #1 b.for indoor display: a must have for your shopfloor



| art. number | size lxd | | m ² | product | | qty. | | qty. | | qty. | ean code |
|-------------------|----------|-----|----------------|---------------------------|-----|------|-----|------|-----|------|-----------------|
| 92 000 038 901 10 | 60 x 40 | 160 | 0.24 | b.for original round 14cm | 118 | 15 | 150 | 25 | 403 | 15 | 8 711904 320874 |
| | | | | b.for original round 16cm | 118 | 10 | 150 | 10 | 403 | 15 | |
| | | | | b.for original round 18cm | 118 | 10 | 150 | 10 | 403 | 10 | |

| art. number | size lxd | | m ² | product | | qty. | | qty. | | qty. | ean code |
|-------------------|----------|-----|----------------|---------------------------|-----|------|-----|------|-----|------|-----------------|
| 92 000 046 904 10 | 60 x 40 | 160 | 0.24 | b.for original round 14cm | 118 | 15 | 150 | 25 | 433 | 15 | 8 711904 484705 |
| | | | | b.for original round 16cm | 118 | 10 | 150 | 15 | 433 | 10 | |
| | | | | b.for original round 18cm | 118 | 8 | 150 | 8 | 433 | 8 | |

| art. number | size lxd | | m ² | product | | qty. | | qty. | | qty. | ean code |
|-------------------|----------|-----|----------------|---------------------------|-----|------|-----|------|-----|------|-----------------|
| 92 000 046 905 10 | 60 x 40 | 160 | 0.24 | b.for original round 18cm | 403 | 8 | 433 | 8 | 541 | 8 | 8 711904 523558 |
| | | | | b.for original round 14cm | 403 | 15 | 433 | 25 | 541 | 15 | |
| | | | | b.for original round 16cm | 403 | 10 | 433 | 15 | 541 | 10 | |



B.FOR ROCK

Rock' your interior with b.for rock! With its geometric design and outspoken colours it's a real eyecatcher. Combine the different sizes and colours; everything is possible!



NICE THINGS TO KNOW ABOUT THE FAMILY



EASY INNER
POT FIT



MADE OUT OF
RECYCLED PLASTICS



LIGHT WEIGHT



LONG-LASTING
COLOUR



rock

colours

118

403

433



b.for rock COLLECTION

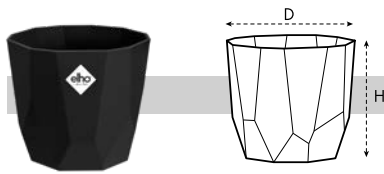

B.FOR ROCK

size = L x D, height = H



EASY INNER
POT FIT

| description | | | | | | | additional information |
|-----------------|------|------|-----|------|---|------|------------------------|
| b.for rock 14cm | 14.6 | 13.0 | 1.5 | 0.16 | 8 | 1120 | |

| | art. number | | ean code | | art. number | | ean code | | art. number | | ean code | | | | | | |
|--|-------------|-------------------|----------|--|-----------------|--|----------|-------------------|-------------|--|-----------------|--|-----|-------------------|---|--|-----------------|
| | 118 | 42 013 014 118 00 | 8 | | 8 711904 302900 | | 403 | 42 013 014 403 00 | 8 | | 8 711904 302948 | | 433 | 42 013 014 433 00 | 8 | | 8 711904 313050 |

| description | | | | | | | additional information |
|-----------------|------|------|-----|------|---|-----|------------------------|
| b.for rock 16cm | 16.7 | 14.7 | 2.3 | 0.22 | 8 | 864 | |

| | art. number | | ean code | | art. number | | ean code | | art. number | | ean code | | | | | | |
|--|-------------|-------------------|----------|--|-----------------|--|----------|-------------------|-------------|--|-----------------|--|-----|-------------------|---|--|-----------------|
| | 118 | 42 015 016 118 00 | 8 | | 8 711904 302986 | | 403 | 42 015 016 403 00 | 8 | | 8 711904 303020 | | 433 | 42 015 016 433 00 | 8 | | 8 711904 313074 |

| description | | | | | | | additional information |
|-----------------|------|------|-----|------|---|-----|-------------------------------------|
| b.for rock 18cm | 18.7 | 16.6 | 3.3 | 0.29 | 6 | 378 | match with self-watering insert Ø17 |

| | art. number | | ean code | | art. number | | ean code | | art. number | | ean code | | | | | | |
|--|-------------|-------------------|----------|--|-----------------|--|----------|-------------------|-------------|--|-----------------|--|-----|-------------------|---|--|-----------------|
| | 118 | 42 017 018 118 00 | 6 | | 8 711904 303068 | | 403 | 42 017 018 403 00 | 6 | | 8 711904 303105 | | 433 | 42 017 018 433 00 | 6 | | 8 711904 313098 |

b.for rock INSTORE PRESENTATIONS



B.FOR ROCK UNIVERSAL FLOOR STAND

- to inspire & activate your shopper, order a complete stand with content:

1 metal frame + 2 content = complete concept



1 METAL FRAME STAND (EMPTY)

| art. number | description | size lxd | h | m ² | | ean code |
|-------------------|------------------------------------|----------|-----|----------------|---|-----------------|
| 19 100 027 150 50 | indoor universal floor stand b.for | 80 x 53 | 198 | 0.42 | 1 | 8 711904 307790 |

2 PRODUCTS (CONTENT FOR STAND)

| art. number | product | | qty. | | qty. | | qty. | ean code |
|-------------------|-----------------|-----|------|-----|------|-----|------|-----------------|
| 42 000 015 901 10 | b.for rock 14cm | 118 | 16 | 403 | 16 | 433 | 8 | 8 711904 336912 |
| | b.for rock 16cm | 118 | 8 | 403 | 8 | 433 | 8 | |
| | b.for rock 18cm | 118 | 12 | 403 | 12 | 433 | 6 | |



B.FOR ROCK INDOOR DISPLAY

- let's seduce your shopper, stimulate the buying impulse



| art. number | size lxd | | m ² | product | | qty. | | qty. | | qty. | ean code |
|-------------------|----------|-----|----------------|-----------------|-----|------|-----|------|-----|------|-----------------|
| 42 000 006 904 10 | 60 x 40 | 160 | 0.24 | b.for rock 14cm | 118 | 15 | 403 | 15 | 433 | 15 | 8 711904 336929 |
| | | | | b.for rock 16cm | 118 | 10 | 403 | 10 | 433 | 10 | |
| | | | | b.for rock 18cm | 118 | 8 | 403 | 8 | 433 | 8 | |



BRUSSELS

A classic shape in warm, harmonious or bright colours. From XL sized pots that include wheels to mini's, but also bowls, oval shapes and hanging baskets are included.

Give your interior an extra touch with our brussels collection.



NICE THINGS TO KNOW ABOUT THE FAMILY

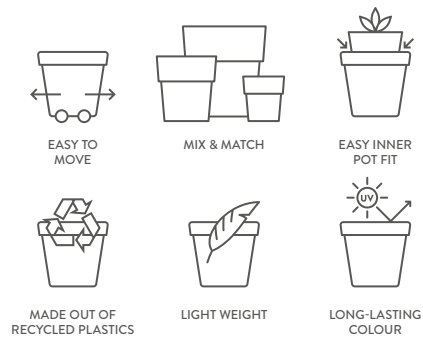

colours

| | | |
|-----|-----|-----|
| 111 | 150 | 180 |
| 255 | 425 | 623 |
| 625 | 707 | 753 |



brussels COLLECTION

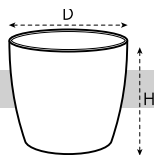

BRUSSELS ROUND MINI

size = L x D, height = H



EASY INNER
POT FIT

| Description | | | | | | | additional information |
|-------------------------|-----|-----|-----|------|----|------|------------------------|
| brussels round mini 7cm | 6.7 | 6.0 | 0.1 | 0.02 | 12 | 8352 | |

| | art. number | | ean code | | art. number | | ean code | | art. number | | ean code | | | |
|--|-------------|-------------------|----------|--|-------------|-----|-------------------|----|-------------|--|----------|-------------------|----|--|
| | 111 | 56 406 207 111 00 | 12 | | | 180 | 56 406 207 180 00 | 12 | | | 625 | 56 406 207 625 00 | 12 | |
| | 150 | 56 406 207 150 00 | 12 | | | 425 | 56 406 207 425 00 | 12 | | | 707 | 56 406 207 707 00 | 12 | |

| Description | | | | | | | additional information |
|---------------------------|------|-----|-----|------|---|------|------------------------|
| brussels round mini 9,5cm | 10.0 | 8.9 | 0.5 | 0.05 | 8 | 1664 | |

| | art. number | | ean code | | art. number | | ean code | | art. number | | ean code | | | |
|--|-------------|-------------------|----------|--|-------------|-----|-------------------|---|-------------|--|----------|-------------------|---|--|
| | 111 | 56 409 210 111 00 | 8 | | | 180 | 56 409 210 180 00 | 8 | | | 625 | 56 409 210 625 00 | 8 | |
| | 150 | 56 409 210 150 00 | 8 | | | 425 | 56 409 210 425 00 | 8 | | | 707 | 56 409 210 707 00 | 8 | |

| Description | | | | | | | additional information |
|----------------------------|------|-----|-----|------|---|------|------------------------|
| brussels round mini 10,5cm | 11.0 | 9.7 | 0.8 | 0.06 | 8 | 1664 | |

| | art. number | | ean code | | art. number | | ean code | | art. number | | ean code | | | |
|--|-------------|-------------------|----------|--|-------------|-----|-------------------|---|-------------|--|----------|-------------------|---|--|
| | 111 | 56 410 211 111 00 | 8 | | | 180 | 56 410 211 180 00 | 8 | | | 625 | 56 410 211 625 00 | 8 | |
| | 150 | 56 410 211 150 00 | 8 | | | 425 | 56 410 211 425 00 | 8 | | | 707 | 56 410 211 707 00 | 8 | |

| Description | | | | | | | additional information |
|----------------------------|------|------|-----|------|---|-----|------------------------|
| brussels round mini 12,5cm | 13.0 | 11.5 | 1.2 | 0.09 | 8 | 720 | |

| | art. number | | ean code | | art. number | | ean code | | art. number | | ean code | | | |
|--|-------------|-------------------|----------|--|-------------|-----|-------------------|---|-------------|--|----------|-------------------|---|--|
| | 111 | 56 411 213 111 00 | 8 | | | 180 | 56 411 213 180 00 | 8 | | | 625 | 56 411 213 625 00 | 8 | |
| | 150 | 56 411 213 150 00 | 8 | | | 425 | 56 411 213 425 00 | 8 | | | 707 | 56 411 213 707 00 | 8 | |

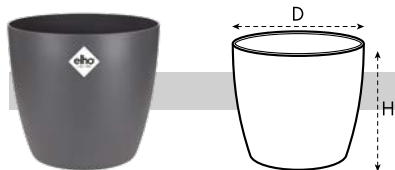

BRUSSELS ROUND

size = L x D, height = H



EASY INNER
POT FIT

| Description | Ø | h | Ltr | Kg | boxes | trucks | additional information |
|---------------------|------|------|-----|------|-------|--------|------------------------|
| brussels round 14cm | 13.5 | 12.6 | 1.4 | 0.12 | 8 | 720 | |

| art. number | ean code | art. number | ean code | art. number | ean code |
|-------------------------|-----------------|-------------------------|-----------------|-------------------------|-----------------|
| 150 56 413 214 150 00 8 | 8 711904 071066 | 425 56 413 214 425 00 8 | 8 711904 071141 | 753 56 413 214 753 00 8 | 8 711904 496760 |
| 255 56 413 214 255 00 8 | 3 711904 496791 | 623 56 413 214 623 00 8 | 8 711904 276911 | | |

| Description | Ø | h | Ltr | Kg | boxes | trucks | additional information |
|---------------------|------|------|-----|------|-------|--------|------------------------|
| brussels round 16cm | 16.0 | 14.7 | 2.2 | 0.16 | 8 | 864 | |

| art. number | ean code | art. number | ean code | art. number | ean code |
|-------------------------|-----------------|-------------------------|-----------------|-------------------------|-----------------|
| 150 56 415 216 150 00 8 | 8 711904 071189 | 425 56 415 216 425 00 8 | 8 711904 071264 | 753 56 415 216 753 00 8 | 8 711904 496821 |
| 255 56 415 216 255 00 8 | 3 711904 496852 | 623 56 415 216 623 00 8 | 8 711904 277093 | | |

| Description | Ø | h | Ltr | Kg | boxes | trucks | additional information |
|---------------------|------|------|-----|------|-------|--------|-------------------------------------|
| brussels round 18cm | 18.3 | 16.8 | 3.3 | 0.23 | 6 | 480 | match with self-watering insert Ø17 |

| art. number | ean code | art. number | ean code | art. number | ean code |
|-------------------------|-----------------|-------------------------|-----------------|-------------------------|-----------------|
| 150 56 417 218 150 00 6 | 8 711904 071301 | 425 56 417 218 425 00 6 | 8 711904 071387 | 753 56 417 218 753 00 6 | 8 711904 496883 |
| 255 56 417 218 255 00 6 | 8 711904 496913 | 623 56 417 218 623 00 6 | 8 711904 277215 | | |

| Description | Ø | h | Ltr | Kg | boxes | trucks | additional information |
|---------------------|------|------|-----|------|-------|--------|-------------------------------------|
| brussels round 20cm | 20.0 | 18.7 | 4.5 | 0.29 | 6 | 480 | match with self-watering insert Ø17 |

| art. number | ean code | art. number | ean code |
|-------------------------|-----------------|-------------------------|-----------------|
| 150 56 419 221 150 00 6 | 8 711904 071424 | 425 56 419 221 425 00 6 | 8 711904 071509 |



| Description | | | | | | | additional information |
|---------------------|------|------|-----|------|---|-----|-------------------------------------|
| brussels round 22cm | 22.3 | 20.6 | 6.2 | 0.37 | 5 | 315 | match with self-watering insert Ø21 |

| | art. number | | ean code | | art. number | | ean code |
|-----|-------------------|---|-----------------|-----|-------------------|---|-----------------|
| 150 | 56 421 223 150 00 | 5 | 8 711904 071547 | 425 | 56 421 223 425 00 | 5 | 8 711904 071622 |

| Description | | | | | | | additional information |
|---------------------|------|------|-----|------|---|-----|------------------------|
| brussels round 25cm | 24.3 | 23.2 | 8.7 | 0.48 | 4 | 168 | |

| | art. number | | ean code | | art. number | | ean code |
|-----|-------------------|---|-----------------|-----|-------------------|---|-----------------|
| 150 | 56 423 225 150 00 | 4 | 8 711904 072339 | 425 | 56 423 225 425 00 | 4 | 8 711904 072377 |

| Description | | | | | | | additional information |
|---------------------|------|------|------|------|---|----|-------------------------------------|
| brussels round 30cm | 29.5 | 27.1 | 14.3 | 0.77 | 4 | 72 | match with self-watering insert Ø28 |

| | art. number | | ean code | | art. number | | ean code |
|-----|-------------------|---|-----------------|-----|-------------------|---|-----------------|
| 150 | 56 427 230 150 00 | 4 | 8 711904 072575 | 425 | 56 427 230 425 00 | 4 | 8 711904 072612 |

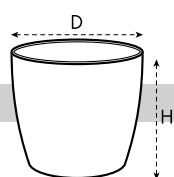

BRUSSELS ROUND WHEELS

size = L x D, height = H



| Description | | | | | | | additional information |
|----------------------------|------|------|------|------|---|----|-------------------------------------|
| brussels round wheels 35cm | 35.0 | 33.0 | 22.8 | 1.41 | 1 | 72 | match with self-watering insert Ø33 |

| | art. number | | ean code | | art. number | | ean code |
|-----|-------------------|---|-----------------|-----|-------------------|---|-----------------|
| 150 | 56 431 235 150 00 | 1 | 8 711904 072698 | 425 | 56 431 235 425 00 | 1 | 8 711904 072735 |

| Description | | | | | | | additional information |
|----------------------------|------|------|------|------|---|----|-------------------------------------|
| brussels round wheels 40cm | 39.0 | 36.5 | 32.2 | 1.80 | 1 | 66 | match with self-watering insert Ø36 |

| | art. number | | ean code | | art. number | | ean code |
|-----|-------------------|---|-----------------|-----|-------------------|---|-----------------|
| 150 | 56 436 239 150 00 | 1 | 8 711904 072810 | 425 | 56 436 239 425 00 | 1 | 8 711904 072858 |

| Description | | | | | | | additional information |
|----------------------------|------|------|------|------|---|----|-------------------------------------|
| brussels round wheels 47cm | 46.5 | 43.5 | 50.0 | 2.70 | 1 | 30 | match with self-watering insert Ø44 |

| | art. number | | ean code | | art. number | | ean code |
|-----|-------------------|---|-----------------|-----|-------------------|---|-----------------|
| 150 | 56 443 247 150 00 | 1 | 8 711904 142322 | 425 | 56 443 247 425 00 | 1 | 8 711904 082260 |

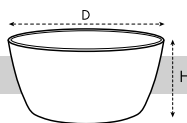

BRUSSELS BOWL

size = L x D, height = H

| Description | | | | | | | additional information |
|--------------------|------|------|-----|------|---|-----|------------------------|
| brussels bowl 23cm | 22.9 | 10.8 | 3.5 | 0.23 | 6 | 378 | |

| | art. number | | ean code | | art. number | | ean code |
|-----|-------------------|---|-----------------|-----|-------------------|---|-----------------|
| 150 | 57 611 423 150 00 | 6 | 8 711904 313531 | 425 | 57 611 423 425 00 | 6 | 8 711904 313555 |

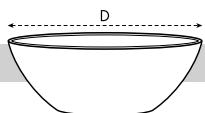

BRUSSELS OVAL

size = L x D, height = H

| description | | | | | | | additional information |
|--------------------|-------------|------|-----|------|---|-----|------------------------|
| brussels oval 36cm | 36.0 x 16.2 | 13.1 | 3.8 | 0.30 | 8 | 480 | |

| | art. number | | ean code | | art. number | | ean code |
|-----|-------------------|---|-----------------|-----|-------------------|---|-----------------|
| 150 | 56 513 336 150 00 | 8 | 8 711904 303822 | 425 | 56 513 336 425 00 | 8 | 8 711904 303846 |

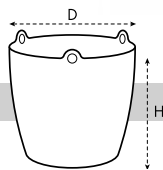

BRUSSELS HANGING BASKET

size = L x D, height = H



EASY INNER
POT FIT

| Description | | | | | | | additional information |
|------------------------------|------|------|-----|------|---|-----|-------------------------------------|
| brussels hanging basket 18cm | 18.3 | 18.0 | 2.9 | 0.26 | 8 | 640 | match with self-watering insert Ø17 |

| | art. number | | ean code | | art. number | | ean code |
|-----|-------------------|---|-----------------|-----|-------------------|---|-----------------|
| 150 | 81 618 018 150 00 | 8 | 8 711904 248833 | 425 | 81 618 018 425 00 | 8 | 8 711904 248864 |



BRUSSELS ROUND



BRUSSELS ROUND UNIVERSAL FLOOR STAND

- to inspire & activate your shopper, order a complete stand with content:

1 metal frame + 2 content = complete concept



1 METAL FRAME STAND (EMPTY)

| art. number | description | size lxd | h | m ² | | ean code |
|-------------------|---------------------------------------|----------|-----|----------------|---|-----------------|
| 19 100 022 150 50 | indoor universal floor stand brussels | 80 x 53 | 198 | 0.42 | 1 | 8 711904 304485 |

2 PRODUCTS (CONTENT FOR STAND)

| art. number | product | | qty. | | qty. | | qty. | ean code |
|-------------------|---------------------|-----|------|-----|------|-----|------|-----------------|
| 56 000 051 904 10 | brussels round 14cm | 150 | 16 | 425 | 16 | 623 | 8 | 8 711904 335328 |
| | brussels round 16cm | 150 | 8 | 425 | 8 | 623 | 8 | |
| | brussels round 18cm | 150 | 12 | 425 | 12 | 623 | 6 | |

| art. number | product | | qty. | | qty. | ean code |
|-------------------|---------------------|-----|------|-----|------|-----------------|
| 56 000 051 905 10 | brussels round 14cm | 150 | 24 | 425 | 24 | 8 711904 351298 |
| | brussels round 16cm | 150 | 16 | 425 | 16 | |
| | brussels round 18cm | 150 | 18 | 425 | 18 | |

| art. number | product | | qty. | | qty. | | qty. | ean code |
|-------------------|---------------------|-----|------|-----|------|-----|------|-----------------|
| 56 000 051 907 10 | brussels round 14cm | 255 | 16 | 623 | 16 | 753 | 8 | 8 711904 508456 |
| | brussels round 16cm | 255 | 8 | 623 | 8 | 753 | 8 | |
| | brussels round 18cm | 255 | 12 | 623 | 12 | 753 | 6 | |



BRUSSELS ROUND MINI UNIVERSAL TABLE STAND

• to inspire & activate your shopper, order a complete stand with content:

1 metal frame + 2 content = complete concept



1 METAL FRAME STAND (EMPTY)

| art. number | description | size lxd | h | m ² | | ean code |
|-------------------|-------------------------------------------|----------|-----|----------------|---|-----------------|
| 56 000 001 000 50 | brussels round mini universal table stand | 56 x 56 | 130 | 0.31 | 1 | 8 711904 509248 |

2 PRODUCTS (CONTENT FOR STAND)

| art. number | product | | qty. | | qty. | | qty. | | qty. | ean code |
|-------------------|----------------------------|-----|------|-----|------|-----|------|-----|------|-----------------|
| 56 000 053 903 10 | brussels round mini 7cm | 111 | 12 | 180 | 24 | 625 | 12 | 707 | 12 | 8 711904 508463 |
| | brussels round mini 9.5cm | 111 | 8 | 180 | 16 | 625 | 16 | 707 | 16 | |
| | brussels round mini 10.5cm | 111 | 8 | 180 | 16 | 625 | 8 | 707 | 8 | |
| | brussels round mini 12.5cm | 111 | 8 | 180 | 8 | 625 | 8 | 707 | 8 | |

| art. number | product | | qty. | | qty. | ean code |
|-------------------|----------------------------|-----|------|-----|------|-----------------|
| 56 000 053 904 10 | brussels round mini 7cm | 150 | 36 | 425 | 24 | 8 711904 509354 |
| | brussels round mini 9.5cm | 150 | 32 | 425 | 24 | |
| | brussels round mini 10.5cm | 150 | 24 | 425 | 16 | |
| | brussels round mini 12.5cm | 150 | 16 | 425 | 16 | |



BRUSSELS ROUND INDOOR DISPLAY

- let's seduce your shopper, stimulate the buying impulse



| art. number | size lxd | | m ² | product | | qty. | | qty. | ean code |
|-------------------|----------|-----|----------------|---------------------|-----|------|-----|------|-----------------|
| 56 000 052 901 10 | 60 x 40 | 160 | 0.24 | brussels round 14cm | 150 | 25 | 425 | 30 | 8 711904 335335 |
| | | | | brussels round 16cm | 150 | 15 | 425 | 20 | |
| | | | | brussels round 18cm | 150 | 12 | 425 | 12 | |

| art. number | size lxd | | m ² | product | | qty. | | qty. | | qty. | ean code |
|-------------------|----------|-----|----------------|---------------------|-----|------|-----|------|-----|------|-----------------|
| 56 000 052 904 10 | 60 x 40 | 160 | 0.24 | brussels round 14cm | 150 | 15 | 425 | 25 | 623 | 15 | 8 711904 335366 |
| | | | | brussels round 16cm | 150 | 10 | 425 | 15 | 623 | 10 | |
| | | | | brussels round 18cm | 150 | 8 | 425 | 8 | 623 | 8 | |

| art. number | size lxd | | m ² | product | | qty. | | qty. | | qty. | ean code |
|-------------------|----------|-----|----------------|---------------------|-----|------|-----|------|-----|------|-----------------|
| 56 000 052 905 10 | 60 x 40 | 160 | 0.24 | brussels round 14cm | 255 | 15 | 623 | 25 | 753 | 15 | 8 711904 508470 |
| | | | | brussels round 16cm | 255 | 10 | 623 | 15 | 753 | 10 | |
| | | | | brussels round 18cm | 255 | 8 | 623 | 8 | 753 | 8 | |



BRUSSELS ROUND MINI DISPLAY

- create awareness, ideal second placement for cross-selling on plant table



| art. number | size lxd | | m ² | product | | qty. | | qty. | ean code | |
|-------------------|----------|----|----------------|---------------------------------|--|------|----|------|----------|-----------------|
| 56 000 056 901 10 | 25 x 23 | 25 | 0.06 | brussels round mini 7cm - basic | | 150 | 36 | 425 | 36 | 8 711904 354367 |

| art. number | size lxd | | m ² | product | | qty. | | qty. | | qty. | | qty. | ean code | |
|-------------------|----------|----|----------------|-------------------------|--|------|----|------|----|------|----|------|----------|-----------------|
| 56 000 056 907 10 | 25 x 23 | 25 | 0.06 | brussels round mini 7cm | | 111 | 18 | 180 | 18 | 625 | 18 | 707 | 18 | 8 711904 508760 |

| art. number | size lxd | | m ² | product | | qty. | | qty. | ean code | |
|-------------------|----------|----|----------------|-----------------------------------|--|------|----|------|----------|-----------------|
| 56 000 057 901 10 | 25 x 23 | 25 | 0.06 | brussels round mini 9.5cm - basic | | 150 | 10 | 425 | 10 | 8 711904 354404 |

| art. number | size lxd | | m ² | product | | qty. | | qty. | | qty. | | qty. | ean code | |
|-------------------|----------|----|----------------|---------------------------|--|------|---|------|---|------|---|------|----------|-----------------|
| 56 000 057 905 10 | 25 x 23 | 25 | 0.06 | brussels round mini 9.5cm | | 111 | 5 | 180 | 5 | 625 | 5 | 707 | 5 | 8 711904 508784 |



BRUSSELS HANGING BASKET SHELF PRESENTATION

- ideal for live presentation of brussels hanging basket



| art. number | description | size lxd | h | m ² | | ean code |
|-------------------|--------------------------------------------|----------|----|----------------|---|-----------------|
| 81 000 028 425 10 | brussels hanging basket shelf presentation | 12 x 16 | 33 | 0.04 | 1 | 8 711904 267131 |



BRUSSELS DIAMOND

You will find the brussels diamond in different shapes and sizes; from round, oval to high.
With its shiny finish and elegant colours it's a real addition to your traditional interior.



NICE THINGS TO KNOW ABOUT THE FAMILY



EASY INNER
POT FIT



MIX & MATCH



MADE OUT OF
RECYCLED PLASTICS



LIGHT WEIGHT



LONG-LASTING
COLOUR



round

oval

round high

easy insert



colours

150

194

201

405

433

brussels diamond COLLECTION

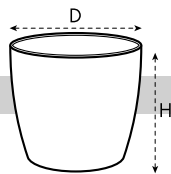

BRUSSELS DIAMOND ROUND

size = L x D, height = H



EASY INNER
POT FIT

| Description | | | | | | | additional information |
|-----------------------------|------|------|-----|------|---|------|------------------------|
| brussels diamond round 14cm | 13.6 | 12.5 | 1.4 | 0.11 | 8 | 1120 | |

| | art. number | | ean code | | art. number | | ean code | | art. number | | ean code |
|--|-------------------|---|----------|--|-------------------|---|----------|--|-------------------|---|----------|
| | 81 413 614 150 00 | 8 | | | 81 413 614 201 00 | 8 | | | 81 413 614 405 00 | 8 | |
| | 81 413 614 194 00 | 8 | | | | | | | | | |

| Description | | | | | | | additional information |
|-----------------------------|------|------|-----|------|---|-----|------------------------|
| brussels diamond round 16cm | 15.8 | 14.5 | 2.2 | 0.16 | 8 | 864 | |

| | art. number | | ean code | | art. number | | ean code | | art. number | | ean code |
|--|-------------------|---|----------|--|-------------------|---|----------|--|-------------------|---|----------|
| | 81 415 616 150 00 | 8 | | | 81 415 616 201 00 | 8 | | | 81 415 616 405 00 | 8 | |
| | 81 415 616 194 00 | 8 | | | | | | | | | |

| Description | | | | | | | additional information |
|-----------------------------|------|------|-----|------|---|-----|-------------------------------------|
| brussels diamond round 18cm | 18.1 | 16.2 | 3.3 | 0.22 | 6 | 480 | match with self-watering insert Ø17 |

| | art. number | | ean code | | art. number | | ean code | | art. number | | ean code |
|--|-------------------|---|----------|--|-------------------|---|----------|--|-------------------|---|----------|
| | 81 417 618 150 00 | 6 | | | 81 417 618 201 00 | 6 | | | 81 417 618 405 00 | 6 | |
| | 81 417 618 194 00 | 6 | | | | | | | | | |

| Description | | | | | | | additional information |
|-----------------------------|------|------|-----|------|---|-----|-------------------------------------|
| brussels diamond round 20cm | 20.0 | 18.6 | 4.5 | 0.30 | 6 | 480 | match with self-watering insert Ø17 |

| | art. number | | ean code | | art. number | | ean code | | art. number | | ean code |
|--|-------------------|---|----------|--|-------------------|---|----------|--|-------------------|---|----------|
| | 81 419 621 150 00 | 6 | | | 81 419 621 201 00 | 6 | | | 81 419 621 405 00 | 6 | |
| | 81 419 621 194 00 | 6 | | | | | | | | | |

| Description | | | | | | | additional information |
|-----------------------------|------|------|-----|------|---|-----|-------------------------------------|
| brussels diamond round 22cm | 22.4 | 20.1 | 6.2 | 0.39 | 3 | 189 | match with self-watering insert Ø21 |

| | art. number | | ean code | | art. number | | ean code | | art. number | | ean code |
|-----|-------------------|---|-----------------|-----|-------------------|---|-----------------|-----|-------------------|---|-----------------|
| 150 | 81 421 623 150 00 | 3 | 8 711904 136819 | 201 | 81 421 623 201 00 | 3 | 8 711904 136871 | 405 | 81 421 623 405 00 | 3 | 8 711904 173258 |
| 194 | 81 421 623 194 00 | 3 | 8 711904 136840 | | | | | | | | |

| Description | | | | | | | additional information |
|-----------------------------|------|------|-----|------|---|-----|-------------------------------------|
| brussels diamond round 25cm | 25.2 | 23.0 | 9.0 | 0.48 | 3 | 126 | match with self-watering insert Ø24 |

| | art. number | | ean code | | art. number | | ean code | | art. number | | ean code |
|-----|-------------------|---|-----------------|-----|-------------------|---|-----------------|-----|-------------------|---|-----------------|
| 150 | 81 423 625 150 00 | 3 | 8 711904 273781 | 201 | 81 423 625 201 00 | 3 | 8 711904 273842 | 405 | 81 423 625 405 00 | 3 | 8 711904 283858 |
| 194 | 81 423 625 194 00 | 3 | 8 711904 273811 | | | | | | | | |

| Description | | | | | | | additional information |
|-----------------------------|------|------|------|------|---|----|-------------------------------------|
| brussels diamond round 30cm | 29.4 | 27.0 | 14.5 | 0.78 | 3 | 72 | match with self-watering insert Ø28 |

| | art. number | | ean code | | art. number | | ean code | | art. number | | ean code |
|-----|-------------------|---|-----------------|-----|-------------------|---|-----------------|-----|-------------------|---|-----------------|
| 150 | 81 427 630 150 00 | 3 | 8 711904 273903 | 201 | 81 427 630 201 00 | 3 | 8 711904 273965 | 405 | 81 427 630 405 00 | 3 | 8 711904 283889 |
| 194 | 81 427 630 194 00 | 3 | 8 711904 273934 | | | | | | | | |

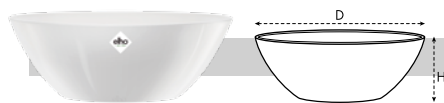

BRUSSELS DIAMOND OVAL

size = L x D, height = H

| Description | | | | | | | additional information |
|----------------------------|-------------|------|-----|------|---|-----|------------------------|
| brussels diamond oval 36cm | 35,5 x 16,5 | 13.0 | 3.8 | 0.26 | 8 | 480 | |

| | art. number | | ean code | | art. number | | ean code | | art. number | | ean code |
|-----|-------------------|---|----------|-----|-------------------|---|----------|-----|-------------------|---|----------|
| 150 | 81 513 336 150 00 | 8 | | 201 | 81 513 336 201 00 | 8 | | 405 | 81 513 336 405 00 | 8 | |
| 194 | 81 513 336 194 00 | 8 | | | | | | | | | |

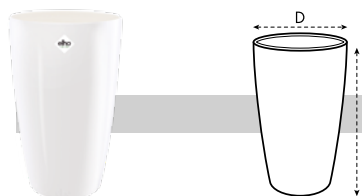

BRUSSELS DIAMOND ROUND HIGH

size = L x D, height = H

| Description | | | | | | | additional information |
|----------------------------------|------|------|------|------|---|----|---------------------------------------------------|
| brussels diamond round high 27cm | 27.0 | 44.1 | 19.0 | 1.15 | 3 | 54 | match with brussels diamond high easy insert 27cm |

| | art. number | | ean code |
|-----|-------------------|---|----------|
| 150 | 81 444 627 150 00 | 3 | |

| Description | | | | | | | additional information |
|----------------------------------|------|------|------|------|---|----|---------------------------------------------------|
| brussels diamond round high 32cm | 32.0 | 55.3 | 33.0 | 2.07 | 1 | 56 | match with brussels diamond high easy insert 32cm |

| | art. number | | ean code |
|-----|-------------------|---|----------|
| 150 | 81 455 632 150 00 | 1 | |

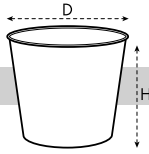

BRUSSELS DIAMOND HIGH EASY INSERT

size = L x D, height = H



| Description | ∅ | ↓ | Ltr | Kg | 📄 | 📦 | additional information |
|----------------------------------------|------|------|------|------|---|-----|-----------------------------------------------|
| brussels diamond high easy insert 27cm | 26.8 | 23.2 | 10.0 | 0.38 | 3 | 504 | 🪴 match with brussels diamond round high 27cm |

| 🪴 | art. number | 📄 | ean code |
|-----|-------------------|---|----------|
| 433 | 83 544 627 433 01 | 3 | |

| Description | ∅ | ↓ | Ltr | Kg | 📄 | 📦 | additional information |
|----------------------------------------|------|------|------|------|---|-----|-----------------------------------------------|
| brussels diamond high easy insert 32cm | 31.5 | 27.6 | 16.0 | 0.50 | 3 | 324 | 🪴 match with brussels diamond round high 32cm |

| 🪴 | art. number | 📄 | ean code |
|-----|-------------------|---|----------|
| 433 | 83 555 632 433 01 | 3 | |

brussels diamond

INSTORE PRESENTATIONS



BRUSSELS DIAMOND ROUND UNIVERSAL FLOOR STAND

- to inspire & activate your shopper, order a complete stand with content:

1 metal frame + 2 content = complete concept



1 METAL FRAME STAND (EMPTY)

| art. number | description | size lxd | h | m ² | | ean code |
|-------------------|---------------------------------------|----------|-----|----------------|---|-----------------|
| 19 100 022 150 50 | indoor universal floor stand brussels | 80 x 53 | 198 | 0.42 | 1 | 8 711904 304485 |

2 PRODUCTS (CONTENT FOR STAND)

| art. number | product | | qty. | | qty. | | qty. | ean code |
|-------------------|-----------------------------|-----|------|-----|------|-----|------|-----------------|
| 81 000 046 901 10 | brussels diamond round 14cm | 150 | 16 | 194 | 16 | 405 | 8 | 8 711904 306540 |
| | brussels diamond round 16cm | 150 | 8 | 194 | 8 | 405 | 8 | |
| | brussels diamond round 18cm | 150 | 12 | 194 | 12 | 405 | 6 | |

| art. number | product | | qty. | | qty. | | qty. | ean code |
|-------------------|-----------------------------|-----|------|-----|------|-----|------|-----------------|
| 81 000 046 904 10 | brussels diamond round 14cm | 150 | 16 | 194 | 8 | 201 | 16 | 8 711904 320522 |
| | brussels diamond round 16cm | 150 | 8 | 194 | 8 | 201 | 8 | |
| | brussels diamond round 18cm | 150 | 12 | 194 | 6 | 201 | 12 | |



BRUSSELS DIAMOND ROUND INDOOR DISPLAY

- ideal presentation to boost your seasonal sales in matching colour combinations



| art. number | size lxd | | m ² | product | | qty. | | qty. | | qty. | ean code |
|------------------|----------|-----|----------------|-----------------------------|-----|------|-----|------|-----|------|-----------------|
| 81 000 043 90110 | 60 x 40 | 160 | 0.24 | brussels diamond round 14cm | 150 | 20 | 194 | 15 | 405 | 20 | 8 711904 305932 |
| | | | | brussels diamond round 16cm | 150 | 15 | 194 | 10 | 405 | 10 | |
| | | | | brussels diamond round 18cm | 150 | 8 | 194 | 8 | 405 | 8 | |

| art. number | size lxd | | m ² | product | | qty. | | qty. | | qty. | ean code |
|------------------|----------|-----|----------------|-----------------------------|-----|------|-----|------|-----|------|-----------------|
| 81 000 043 90410 | 60 x 40 | 160 | 0.24 | brussels diamond round 14cm | 150 | 20 | 194 | 15 | 201 | 20 | 8 711904 318475 |
| | | | | brussels diamond round 16cm | 150 | 15 | 194 | 10 | 201 | 10 | |
| | | | | brussels diamond round 18cm | 150 | 8 | 194 | 8 | 201 | 8 | |



BRUSSELS ORCHID

The orchid is a plant with beautiful flowers and deserves a specially designed pot; our pots with raised bottom ensure an optimal humid climate for the orchid's roots. Through the transparent pots, you can easily see when your orchid needs watering, so you can fully enjoy the beauty of your orchid.

NICE THINGS TO KNOW ABOUT THE FAMILY



EASY INNER POT FIT



ELEVATED BOTTOM FOR HYDRATION AND AERATION



MADE OUT OF RECYCLED PLASTICS



LIGHT WEIGHT



LONG-LASTING COLOUR



diamond orchid high



orchid high



orchid duo



orchid

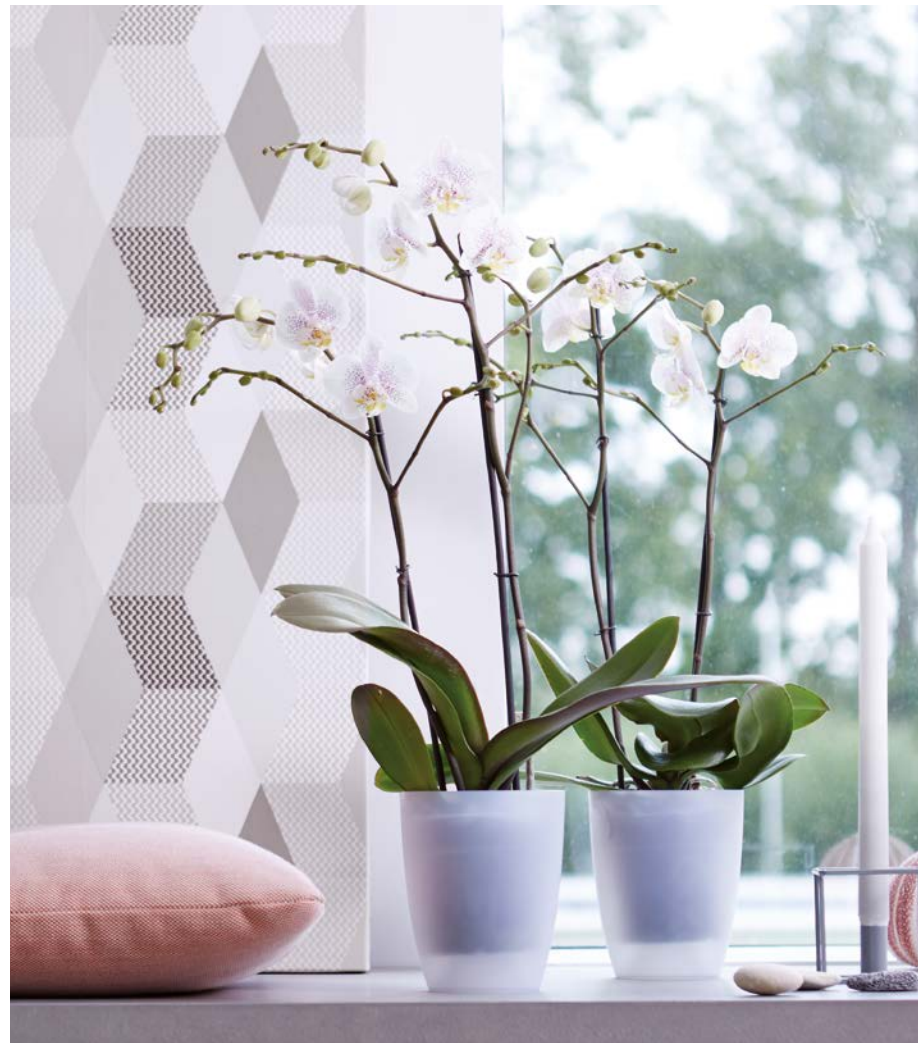

colours

100

150

235



brussels orchid COLLECTION

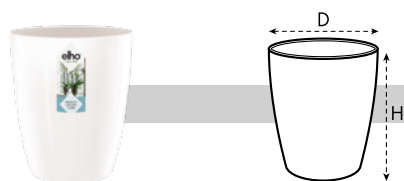

BRUSSELS DIAMOND ORCHID HIGH

size = L x D, height = H



EASY INNER POT FIT

ELEVATED BOTTOM LESS SOIL NEEDED

| Description | | | | | | | additional information |
|-------------------------------------|------|------|-----|------|----|-----|------------------------|
| brussels diamond orchid high 12,5cm | 12.5 | 15.0 | 1.3 | 0.12 | 12 | 804 | |

| | art. number | | ean code | | art. number | | ean code |
|-----|-------------------|----|-----------------|-----|-------------------|----|-----------------|
| 150 | 81 415 613 150 01 | 12 | 8 711904 126056 | 235 | 81 415 613 235 01 | 12 | 8 711904 126087 |

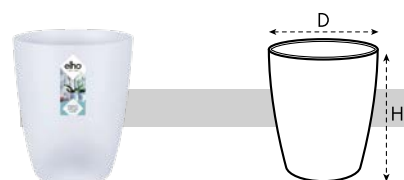

BRUSSELS ORCHID HIGH

size = L x D, height = H



EASY INNER POT FIT

ELEVATED BOTTOM LESS SOIL NEEDED

| Description | | | | | | | additional information |
|-----------------------------|------|------|-----|------|----|-----|------------------------|
| brussels orchid high 12,5cm | 12.5 | 15.5 | 1.3 | 0.10 | 12 | 804 | |

| | art. number | | ean code | | art. number | | ean code | | art. number | | ean code |
|-----|-------------------|----|-----------------|-----|-------------------|----|-----------------|-----|-------------------|----|-----------------|
| 100 | 56 414 213 100 01 | 12 | 8 711904 276973 | 150 | 56 414 213 150 01 | 12 | 8 711904 232115 | 235 | 56 414 213 235 01 | 12 | 8 711904 232207 |

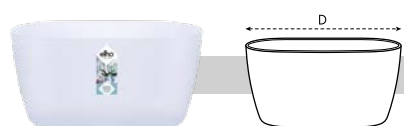

BRUSSELS ORCHID DUO

size = L x D, height = H



EASY INNER POT FIT

ELEVATED BOTTOM FOR HYDRATION AND AERATION

| Description | | | | | | | additional information |
|--------------------------|-------------|------|-----|------|---|-----|------------------------|
| brussels orchid duo 25cm | 24.8 x 13.4 | 12.0 | 2.8 | 0.17 | 6 | 540 | |

| | art. number | | ean code | | art. number | | ean code | | art. number | | ean code |
|-----|-------------------|---|-----------------|-----|-------------------|---|-----------------|-----|-------------------|---|-----------------|
| 100 | 56 413 225 100 00 | 6 | 8 711904 313395 | 150 | 56 413 225 150 00 | 6 | 8 711904 313418 | 235 | 56 413 225 235 00 | 6 | 8 711904 313432 |

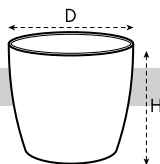

BRUSSELS ORCHID

size = L x D, height = H



EASY INNER POT FIT

| description | | | | | | | additional information |
|------------------------|------|------|-----|------|---|-----|------------------------|
| brussels orchid 12,5cm | 13.0 | 11.5 | 1.2 | 0.09 | 8 | 720 | |

| | art. number | | ean code |
|-----|-------------------|---|-----------------|
| 100 | 56 411 213 100 00 | 8 | 8 711904 082581 |

| Description | | | | | | | additional information |
|----------------------|------|------|-----|------|---|-----|------------------------|
| brussels orchid 16cm | 16.0 | 14.6 | 2.2 | 0.16 | 8 | 864 | |

| | art. number | | ean code |
|-----|-------------------|---|-----------------|
| 100 | 56 415 216 100 01 | 8 | 8 711904 114404 |

brussels orchid

INSTORE PRESENTATIONS



BRUSSELS ORCHID HIGH & ORCHID DUO UNIVERSAL FLOOR STAND

NEW
COMBINATION



- to inspire & activate your shopper, order a complete stand with content:

1 metal frame + 2 content = complete concept

1 METAL FRAME STAND (EMPTY)

| art. number | description | size lxd | h | m ² | | ean code |
|-------------------|---------------------------------------|----------|-----|----------------|---|-----------------|
| 19 100 022 150 50 | indoor universal floor stand brussels | 80 x 53 | 198 | 0.42 | 1 | 8 711904 304485 |

2 PRODUCTS (CONTENT FOR STAND)

| art. number | product | | qty. | | qty. | | qty. | ean code |
|-------------------|-----------------------------|-----|------|-----|------|-----|------|------------------|
| 56 000 058 904 10 | brussels orchid high 12.5cm | 100 | 24 | 150 | 24 | 235 | 24 | 8 711904 1523572 |
| | brussels orchid duo 25cm | 100 | 18 | 150 | 12 | 235 | 12 | |
| | brussels orchid 12.5cm | 100 | 16 | | | | | |
| | brussels orchid 16cm | 100 | 8 | | | | | |



BRUSSELS ORCHID HIGH & ORCHID DUO INDOOR DISPLAY

NEW
COMBINATION

#1
DISPLAY



- #1 best-selling brussels display: a must have for your shopfloor!

| art. number | size lxd | | m ² | product | | qty. | | qty. | | qty. | ean code |
|-------------------|----------|-----|----------------|-----------------------------|-----|------|-----|------|-----|------|------------------|
| 56 000 058 903 10 | 60 x 40 | 160 | 0.24 | brussels orchid high 12.5cm | 100 | 15 | 150 | 36 | 235 | 36 | 8 711904 1523565 |
| | | | | brussels round mini 12.5cm | 100 | 14 | | | | | |
| | | | | brussels orchid duo 25cm | 100 | 12 | 150 | 18 | 235 | 18 | |
| | | | | brussels orchid 16cm | 100 | 10 | | | | | |



TRANSPARENT ORCHID INDOOR DISPLAY

- boost your sales: unique new display with all best-selling transparent orchid pots



| art. number | size lxd | | m ² | product | | qty. | ean code |
|-------------------|----------|-----|----------------|----------------------------------|-----|------|---------------------|
| 56 000 058 100 10 | 60 x 40 | 160 | 0.24 | brussels orchid high 12.5cm | 100 | 36 | 8 711904 484750 |
| | | | | brussels orchid duo 25cm | 100 | 21 | |
| | | | | brussels orchid 12.5cm | 100 | 40 | |
| | | | | brussels orchid 16cm | 100 | 24 | |
| | | | | green basics orchid 13cm | 100 | 40 | |
| | | | | green basics orchid 15cm | 100 | 60 | |
| | | | | green basics orchid 17cm | 100 | 60 | |
| | | | | green basics orchid schotel 10cm | 100 | 20 | |
| | | | | green basics orchid schotel 14cm | 100 | 20 | |



SELF-WATERING INSERT

Not everyone is blessed with a natural green thumb. The self-watering insert provides peace of mind for conscious consumers looking to green up their home. Easy to use, fits most pots and many other pots including ceramic ones. Made out of recycled plastics.



NICE THINGS TO KNOW ABOUT THE FAMILY

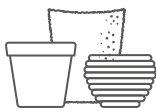

FITS ALL POTS



CAREFREE WATERING SYSTEM



WATER LEVEL INDICATOR



MADE OUT OF RECYCLED PLASTICS



LIGHT WEIGHT



round

CHOOSE THE RIGHT FIT

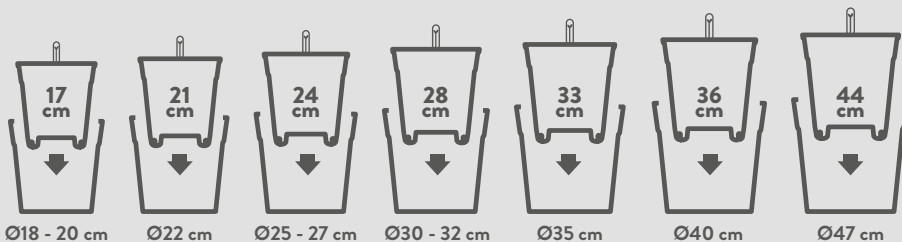

WATCH THE SELF WATERING INSERT PRODUCT VIDEO

colour

433

self-watering insert COLLECTION

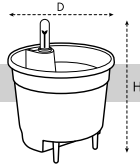

SELF-WATERING INSERT

size = L x D, height = H
for matching products, see p. 326-327

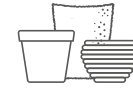

FITS ALL POTS



CAREFREE WATERING SYSTEM



WATER LEVEL INDICATOR

| Description | | | | | | | additional information |
|---------------------------|------|------|-----|------|---|-----|---------------------------|
| self-watering insert 17cm | 16.8 | 15.8 | 2.0 | 0.12 | 5 | 900 | fits size pot: Ø18 - 20cm |

| | art. number | | ean code |
|-----|-------------------|---|-----------------|
| 433 | 83 162 170 433 00 | 5 | 8 711904 331566 |

| Description | | | | | | | additional information |
|---------------------------|------|------|-----|------|---|-----|------------------------|
| self-watering insert 21cm | 20.7 | 19.5 | 4.0 | 0.19 | 5 | 500 | fits size pot: Ø22cm |

| | art. number | | ean code |
|-----|-------------------|---|-----------------|
| 433 | 83 199 210 433 00 | 5 | 8 711904 331573 |









| Description | | | | | | | additional information |
|---------------------------|------|------|-----|------|---|-----|---------------------------|
| self-watering insert 24cm | 23.7 | 22.2 | 5.8 | 0.25 | 5 | 375 | fits size pot: Ø25 - 27cm |



| | art. number | | ean code |
|-----|-------------------|---|-----------------|
| 433 | 83 226 240 433 00 | 5 | 8 711904 331580 |









| Description | | | | | | | additional information |
|---------------------------|------|------|-----|------|---|-----|---------------------------|
| self-watering insert 28cm | 27.7 | 25.5 | 9.0 | 0.38 | 5 | 275 | fits size pot: Ø30 - 32cm |



| | art. number | | ean code |
|-----|-------------------|---|-----------------|
| 433 | 83 260 280 433 00 | 5 | 8 711904 331597 |









self-watering insert



| Description |  |  |  |  |  |  | additional information |
|---------------------------|-----------------------------------------------------------------------------------|-----------------------------------------------------------------------------------|-----------------------------------------------------------------------------------|------------------------------------------------------------------------------------|-------------------------------------------------------------------------------------|-------------------------------------------------------------------------------------|----------------------------------------------------------------------------------------------------------------------------------------------------------------------------------------------|
| self-watering insert 33cm | 33.3 | 30.7 | 16.0 | 0.56 | 5 | 140 |   fits size pot: Ø35cm |

|  | art. number |  | ean code |
|-----------------------------------------------------------------------------------|-------------------|-----------------------------------------------------------------------------------|------------------------------------------------------------------------------------------------------|
| 433 | 83 311 330 433 00 | 5 |  8 711904 331603 |

| Description |  |  |  |  |  |  | additional information |
|---------------------------|-----------------------------------------------------------------------------------|-----------------------------------------------------------------------------------|-----------------------------------------------------------------------------------|------------------------------------------------------------------------------------|-------------------------------------------------------------------------------------|-------------------------------------------------------------------------------------|----------------------------------------------------------------------------------------------------------------------------------------------------------------------------------------------|
| self-watering insert 36cm | 36.0 | 34.5 | 22.0 | 0.70 | 5 | 120 |   fits size pot: Ø40cm |

|  | art. number |  | ean code |
|-----------------------------------------------------------------------------------|-------------------|-----------------------------------------------------------------------------------|------------------------------------------------------------------------------------------------------|
| 433 | 83 349 364 433 00 | 5 |  8 711904 331726 |

| Description |  |  |  |  |  |  | additional information |
|---------------------------|------------------------------------------------------------------------------------|------------------------------------------------------------------------------------|------------------------------------------------------------------------------------|-------------------------------------------------------------------------------------|--------------------------------------------------------------------------------------|--------------------------------------------------------------------------------------|--------------------------------------------------------------------------------------------------------------------------------------------------------------------------------------------------|
| self-watering insert 44cm | 42.8 | 39.0 | 36.0 | 1.02 | 5 | 220 |   fits size pot: Ø47cm |

|  | art. number |  | ean code |
|-------------------------------------------------------------------------------------|-------------------|-------------------------------------------------------------------------------------|--------------------------------------------------------------------------------------------------------|
| 433 | 83 398 434 433 00 | 5 |  8 711904 331627 |

self-watering insert INSTORE PRESENTATIONS



SELF-WATERING INSERT DISPLAY

- must have presentation for product placement & easy cross-selling



| art. number | size lxd | | m ² | product | | qty. | ean code |
|-------------------|----------|-----|----------------|---------------------------|-----|------|---------------------|
| 83 000 001 433 10 | 60 x 40 | 160 | 0.24 | self-watering insert 17cm | 433 | 30 | 8 711904 509071 |
| | | | | self-watering insert 21cm | 433 | 14 | |
| | | | | self-watering insert 24cm | 433 | 15 | |
| | | | | self-watering insert 28cm | 433 | 5 | |
| | | | | self-watering insert 33cm | 433 | 5 | |



SELF-WATERING INSERT CONCEPT STAND

- proven sales succes & ideal cross-seller: order this complete concept of stand & content (stand is including content)



STAND INCLUDING CONTENT

| art. number | description | size lxd | h | m ² | | ean code |
|-------------------|------------------------------------|----------|-----|----------------|---|---------------------|
| 19 100 035 150 50 | self-watering insert concept stand | 94 x 80 | 198 | 0.75 | 1 | 8 711904 338053 |

| product | | qty. |
|---------------------------|-----|------|
| self-watering insert 17cm | 433 | 20 |
| self-watering insert 21cm | 433 | 20 |
| self-watering insert 24cm | 433 | 40 |
| self-watering insert 28cm | 433 | 30 |
| self-watering insert 33cm | 433 | 15 |
| self-watering insert 36cm | 433 | 15 |
| self-watering insert 44cm | 433 | 10 |



SELF-WATERING INSERT



FLOORPROTECTOR

Do you have a ceramic flowerpot and are you worried about damaging your floor? With the floorprotector you protect any surface in your house such as wooden floors, tables or windowsills. This practical aid prevents damp and dirt stains and scratches.

NICE THINGS TO KNOW ABOUT THE FAMILY



PROTECTS AGAINST RINGS

PROTECTS AGAINST SCRATCHES

INVISIBLE PROTECTION



floorprotector



AVAILABLE
IN SIZES

10, 12.5, 15, 18, 21 & 25cm

colour

100

floorprotector COLLECTION

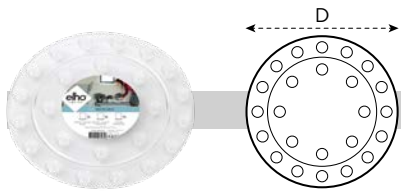

FLOORPROTECTOR ROUND

size = L x D, height = H



| Description | | | | | | | additional information |
|---------------------------|------|-----|---|------|----|-------|------------------------|
| floorprotector round 10cm | 10.0 | 1.0 | - | 0.01 | 10 | 14400 | |



| | art. number | | ean code |
|-----|-------------------|----|-----------------|
| 100 | 55 402 010 100 00 | 10 | 8 711904 074364 |



| Description | | | | | | | additional information |
|-----------------------------|------|-----|---|------|----|------|------------------------|
| floorprotector round 12,5cm | 12.5 | 1.0 | - | 0.03 | 10 | 8640 | |





| | art. number | | ean code |
|-----|-------------------|----|-----------------|
| 100 | 55 402 012 100 00 | 10 | 8 711904 074371 |



| Description | | | | | | | additional information |
|---------------------------|------|-----|---|------|----|------|------------------------|
| floorprotector round 15cm | 15.0 | 1.5 | - | 0.05 | 10 | 4290 | |

| | art. number | | ean code |
|-----|-------------------|----|-----------------|
| 100 | 55 402 015 100 00 | 10 | 8 711904 070618 |



| Description |  |  |  |  |  |  | additional information |
|---------------------------|-----------------------------------------------------------------------------------|-----------------------------------------------------------------------------------|-----------------------------------------------------------------------------------|------------------------------------------------------------------------------------|-------------------------------------------------------------------------------------|-------------------------------------------------------------------------------------|------------------------|
| floorprotector round 18cm | 17.8 | 1.5 | - | 0.06 | 10 | 2970 | |

|  | art. number |  | ean code |
|-----------------------------------------------------------------------------------|-------------------|-----------------------------------------------------------------------------------|------------------------------------------------------------------------------------------------------|
| 100 | 55 402 018 100 00 | 10 |  8 711904 080082 |

| Description |  |  |  |  |  |  | additional information |
|---------------------------|-----------------------------------------------------------------------------------|-----------------------------------------------------------------------------------|-----------------------------------------------------------------------------------|------------------------------------------------------------------------------------|-------------------------------------------------------------------------------------|-------------------------------------------------------------------------------------|------------------------|
| floorprotector round 21cm | 21.0 | 1.5 | - | 0.09 | 10 | 2200 | |

|  | art. number |  | ean code |
|-----------------------------------------------------------------------------------|-------------------|-----------------------------------------------------------------------------------|------------------------------------------------------------------------------------------------------|
| 100 | 55 402 020 100 00 | 10 |  8 711904 070632 |

| Description |  |  |  |  |  |  | additional information |
|---------------------------|------------------------------------------------------------------------------------|------------------------------------------------------------------------------------|------------------------------------------------------------------------------------|-------------------------------------------------------------------------------------|--------------------------------------------------------------------------------------|--------------------------------------------------------------------------------------|------------------------|
| floorprotector round 25cm | 25.0 | 1.5 | - | 0.12 | 10 | 1540 | |

|  | art. number |  | ean code |
|-------------------------------------------------------------------------------------|-------------------|-------------------------------------------------------------------------------------|--------------------------------------------------------------------------------------------------------|
| 100 | 55 402 025 100 00 | 10 |  8 711904 070656 |



FLOORPROTECTOR UNIVERSAL SUPPORT STAND

• to order a complete stand:

1 metal frame + 2 2 x content = complete concept, also possible to combine with saucer or uni-saucer



1 METAL FRAME STAND (EMPTY)

| art. number | description | size lxd | h | m ² | | ean code |
|-------------------|---------------------------------|----------|-----|----------------|---|-----------------|
| 19 100 033 150 50 | universal compact support stand | 65 x 55 | 198 | 0.36 | 1 | 8 711904 337766 |

2 PRODUCTS (CONTENT FOR STAND)

| art. number | product | | qty. | ean code |
|-------------------|-----------------------------|-----|------|-----------------|
| 13 000 033 100 10 | floorprotector round 10cm | 100 | 100 | 8 711904 339562 |
| | floorprotector round 12.5cm | 100 | 80 | |
| | floorprotector round 15cm | 100 | 60 | |
| | floorprotector round 18cm | 100 | 60 | |
| | floorprotector round 21cm | 100 | 60 | |
| | floorprotector round 25cm | 100 | 60 | |

CAN ALSO BE MATCHED WITH:

| art. number | description | can be found on page: | | ean code |
|-------------------|-----------------------------------|-----------------------|-----|-----------------|
| 13 000 034 270 10 | universal saucer advised quantity | 132 | 270 | 8 711904 339579 |
| 13 000 036 425 10 | universal saucer advised quantity | 133 | 425 | 8 711904 339593 |
| 60 000 014 100 10 | uni-saucer advised quantity | 134 | 100 | 8 711904 339609 |



FLOORPROTECTOR



A person in a light blue long-sleeved shirt is watering a large, lush green fern in a dark grey, cylindrical pot. The person is holding a dark grey watering can with a white handle and spout. The fern is overflowing from the pot. In the background, there is a wooden cutting board on a shelf, a white teapot, and two white mugs. Another potted plant is visible in the background. The scene is set in a bright, indoor environment.

*watering cans
& sprayers*
COLLECTION



*brussels watering
can & sprayer*

brussels COLLECTION

Classic shapes in warm and harmonious colours are the focus of this watering can and sprayer. Both matches perfectly with the brussels flowerpots.

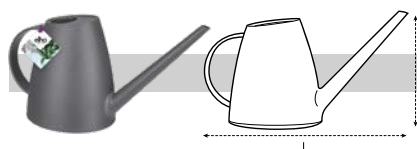

BRUSSELS WATERING CAN

size = L x D, height = H

| Description | ◀▶ | ⬇️ | Ltr | Kg | 📦 | 🏠 | additional information |
|------------------------------|-------------|------|-----|------|---|-----|------------------------|
| brussels watering can 1,8ltr | 33.0 x 13.5 | 17.0 | 1.8 | 0.20 | 5 | 210 | |

| 📦 | art. number | 📦 | ean code | 📦 | art. number | 📦 | ean code | 📦 | art. number | 📦 | ean code |
|-----|-------------------|---|-----------------|-----|-------------------|---|-----------------|-----|-------------------|---|-----------------|
| 150 | 42 301 800 150 00 | 5 | 8 711904 303389 | 425 | 42 301 800 425 00 | 5 | 8 711904 303402 | 623 | 42 301 800 623 00 | 5 | 8 711904 303464 |



BRUSSELS SPRAYER

size = L x D, height = H

| Description | ◀▶ | ⬇️ | Ltr | Kg | 📦 | 🏠 | additional information |
|-------------------------|------------|------|-----|------|---|-----|------------------------|
| brussels sprayer 0,7ltr | 11.3 x 8.8 | 22.5 | 0.7 | 0.12 | 5 | 450 | |

| 📦 | art. number | 📦 | ean code | 📦 | art. number | 📦 | ean code | 📦 | art. number | 📦 | ean code |
|-----|-------------------|---|-----------------|-----|-------------------|---|-----------------|-----|-------------------|---|-----------------|
| 150 | 42 300 700 150 00 | 5 | 8 711904 303266 | 425 | 42 300 700 425 00 | 5 | 8 711904 303280 | 623 | 42 300 700 623 00 | 5 | 8 711904 303341 |



*b. for soft watering
can & sprayer*

b.for soft COLLECTION

Soft and round shapes are the focus of this stylish watering can and sprayer. The unique design features two colours for a modern look. Both matches perfectly with the b.for soft flowerpots.

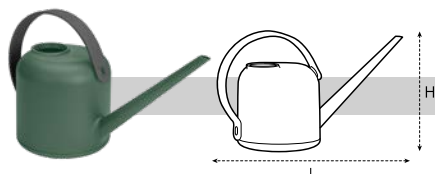

B.FOR SOFT WATERING CAN

size = L x D, height = H

| Description | | | | ◀▶ | ⬇ | Ltr | Kg | 📦 | 📦 | additional information |
|--------------------------------|--|--|--|-------------|------|-----|------|---|-----|------------------------|
| b.for soft watering can 1,7ltr | | | | 29.5 x 13.5 | 17.2 | 1.7 | 0.20 | 5 | 210 | |

| 📦 | art. number | 📦 | ean code | 📦 | art. number | 📦 | ean code | 📦 | art. number | 📦 | ean code |
|------------|-------------------|---|----------|------------|-------------------|---|----------|------------|-------------------|---|----------|
| 150 762 | 42 201 700 150 01 | 5 | | 360 425 | 42 201 700 360 00 | 5 | | 425 150 | 42 201 700 425 01 | 5 | |

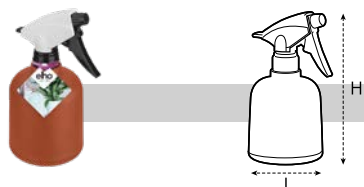

B.FOR SOFT SPRAYER

size = L x D, height = H

| Description | | | | ◀▶ | ⬇ | Ltr | Kg | 📦 | 📦 | additional information |
|---------------------------|--|--|--|------------|------|-----|------|---|-----|------------------------|
| b.for soft sprayer 0,6ltr | | | | 12.0 x 9.5 | 19.0 | 0.6 | 0.12 | 5 | 900 | |

| 📦 | art. number | 📦 | ean code | 📦 | art. number | 📦 | ean code | 📦 | art. number | 📦 | ean code |
|------------|-------------------|---|----------|------------|-------------------|---|----------|------------|-------------------|---|----------|
| 150 425 | 42 200 600 150 01 | 5 | | 425 360 | 42 200 600 425 01 | 5 | | 762 150 | 42 200 600 762 00 | 5 | |



*aquarius watering
can & sprayer*

aquarius COLLECTION

This timeless watering can and sprayer with practical design are comfortable to use and easy to fill due to the ergonomic grip and wide opening.

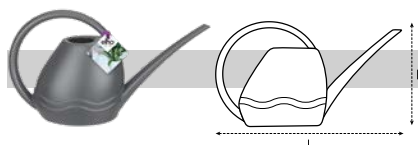

AQUARIUS WATERING CAN

size = L x D, height = H

| Description | | | | | | | additional information |
|------------------------------|-------------|------|-----|------|---|-----|------------------------|
| aquarius watering can 1,5ltr | 34.8 x 10.8 | 19.9 | 1.5 | 0.15 | 5 | 210 | |

| | art. number | | ean code | | art. number | | ean code | | art. number | | ean code |
|-----|-------------------|---|----------|-----|-------------------|---|----------|-----|-------------------|---|----------|
| 150 | 53 801 500 150 00 | 5 | | 397 | 53 801 500 397 00 | 5 | | 425 | 53 801 500 425 00 | 5 | |
| 235 | 53 801 500 235 00 | 5 | | | | | | | | | |

| Description | | | | | | | additional information |
|------------------------------|-------------|------|-----|------|---|-----|------------------------|
| aquarius watering can 3,5ltr | 44.8 x 13.8 | 25.3 | 3.5 | 0.34 | 4 | 112 | |

| | art. number | | ean code | | art. number | | ean code | | art. number | | ean code |
|-----|-------------------|---|----------|-----|-------------------|---|----------|-----|-------------------|---|----------|
| 150 | 53 803 500 150 00 | 4 | | 397 | 53 803 500 397 00 | 4 | | 425 | 53 803 500 425 00 | 4 | |
| 235 | 53 803 500 235 00 | 4 | | | | | | | | | |



AQUARIUS SPRAYER

size = L x D, height = H

| Description | | | | | | | additional information |
|-------------------------|------------|------|-----|------|---|-----|------------------------|
| aquarius sprayer 0,7ltr | 14.0 x 8.5 | 25.0 | 0.7 | 0.10 | 5 | 350 | |

| | art. number | | ean code | | art. number | | ean code | | art. number | | ean code |
|-----|-------------------|---|----------|-----|-------------------|---|----------|-----|-------------------|---|----------|
| 150 | 53 800 700 150 00 | 5 | | 397 | 53 800 700 397 00 | 5 | | 425 | 53 800 700 425 00 | 5 | |
| 235 | 53 800 700 235 00 | 5 | | | | | | | | | |



plunge

plunge COLLECTION

Water your plants in a stylish way with the plunge! This watering can has a unique design and is created by Dutch designer Robert Bronwasser in collaboration with elho. The plunge is a true eyecatcher, so there is no need to store it.

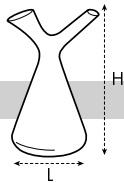

PLUNGE WATERING CAN

size = L x D, height = H

| Description | | | | | | | additional information |
|----------------------------|--|-------------|------|-----|------|---|------------------------|
| plunge watering can 1,7ltr | | 19.6 x 14.8 | 29.5 | 1.7 | 0.17 | 5 | 300 |

| | art. number | | ean code | | art. number | | ean code | | art. number | | ean code |
|-----|-------------------|---|----------|-----|-------------------|---|----------|-----|-------------------|---|----------|
| 118 | 21 930 015 118 00 | 5 | | 403 | 21 930 015 403 00 | 5 | | 433 | 21 930 015 433 00 | 5 | |



acqua care

aqua care COLLECTION

The easiest and most user friendly watering system for your plant; the aqua care! Do you love plants but often forget to water them? This unique watering system ensures that your indoor plants always get the right amount of water. The aqua care releases water when necessary. Perfect for when you're gone for the weekend!

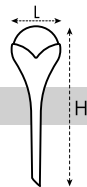

AQUA CARE

size = L x D, height = H

| Description | | | | | | | additional information |
|-------------------|------------|------|-----|------|---|-----|------------------------|
| aqua care (set/2) | 17.3 x 8.8 | 32.0 | 0.4 | 0.10 | 8 | 336 | |

| | art. number | | ean code | | art. number | | ean code | | art. number | | ean code |
|-----|-------------------|---|-----------------|-----|-------------------|---|-----------------|-----|-------------------|---|-----------------|
| 100 | 21 029 208 100 00 | 8 | 8 711904 148973 | 261 | 21 029 208 261 00 | 8 | 8 711904 240554 | 366 | 21 029 208 366 00 | 8 | 8 711904 152611 |



*green basics
watering can*

green basics COLLECTION

If you've started working outside in your (vegetable) garden, this is an absolute must have for healthy plants. You're working completely green; the watering can is made of 100% recycled material and is of the best quality so you'll enjoy it for years to come.

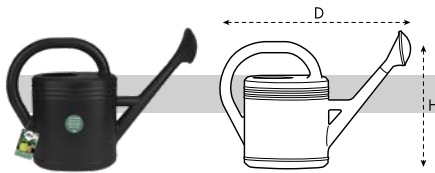

GREEN BASICS WATERING CAN

size = L x D, height = H



MADE OUT OF RECYCLED PLASTICS

| Description | | | | | | additional information |
|---------------------------------|-------------|------|------|------|---|------------------------|
| green basics watering can 10ltr | 56.8 x 18.3 | 36.8 | 10.0 | 0.64 | 6 | 60 |

| | art. number | | ean code | | art. number | | ean code |
|-----|-------------------|---|----------|-----|-------------------|---|----------|
| 397 | 21 938 025 397 00 | 6 | | 433 | 21 938 025 433 00 | 6 | |

watering cans & sprayers INSTORE PRESENTATIONS



BRUSSELS WATERING CANS & SPRAYERS FLOOR STAND

- to inspire & activate your shopper, order a complete stand with content:

1 metal frame + 2 content = complete concept



1 METAL FRAME STAND (EMPTY)

| art. number | description | size lxd | h | m ² | | ean code |
|------------------|------------------------------------------------|----------|-----|----------------|---|-----------------|
| 21 000 021150 50 | watering cans & sprayers universal floor stand | 80 x 53 | 198 | 0.42 | 1 | 8 711904 304515 |

2 PRODUCTS (CONTENT FOR STAND)

| art. number | product | | qty. | | qty. | | qty. | ean code |
|-------------------|------------------------------|-----|------|-----|------|-----|------|-----------------|
| 42 000 011 901 10 | brussels watering can 1.8ltr | 150 | 10 | 425 | 10 | 623 | 5 | 8 711904 306250 |
| | brussels sprayer 0.7ltr | 150 | 10 | 425 | 10 | 623 | 5 | |



BRUSSELS WATERING CANS & SPRAYERS TABLE STAND

- to inspire & activate your shopper, order a complete stand with content:

1 metal frame + 2 content = complete concept



1 METAL FRAME STAND (EMPTY)

| art. number | description | size lxd | h | m ² | | ean code |
|-------------------|--------------------------------------|-----------|-----|----------------|---|-----------------|
| 21 000 008 150 30 | watering cans & sprayers table stand | 109 x 109 | 106 | 1.19 | 1 | 8 711904 217204 |

2 PRODUCTS (CONTENT FOR STAND)

| art. number | product | | qty. | | qty. | | qty. | ean code |
|-------------------|------------------------------|-----|------|-----|------|-----|------|-----------------|
| 42 000 010 901 10 | brussels watering can 1.8ltr | 150 | 5 | 425 | 10 | 623 | 5 | 8 711904 306236 |
| | brussels sprayer 0.7ltr | 150 | 5 | 425 | 10 | 623 | 5 | |



B.FOR SOFT WATERING CANS & SPRAYERS FLOOR STAND



• to inspire & activate your shopper, order a complete stand with content:

1 metal frame + 2 content = complete concept

1 METAL FRAME STAND (EMPTY)

| art. number | description | size lxd | h | m ² | | ean code |
|-------------------|------------------------------------------------|----------|-----|----------------|---|-----------------|
| 21 000 021 150 50 | watering cans & sprayers universal floor stand | 80 x 53 | 198 | 0.42 | 1 | 8 711904 304515 |

2 PRODUCTS (CONTENT FOR STAND)

| art. number | product | | qty. | | qty. | ean code |
|-------------------|------------------------------|------------|------|------------|------|-----------------|
| 42 000 009 903 10 | b.for soft watering can 1.7l | 360 425 | 20 | 425 150 | 20 | 8 711904 337230 |
| | b.for soft sprayer 0.6l | 425 360 | 10 | 150 425 | 10 | |

| art. number | product | | qty. | | qty. | ean code |
|-------------------|------------------------------|------------|------|------------|------|-----------------|
| 42 000 009 904 10 | b.for soft watering can 1.7l | 150 762 | 20 | 425 150 | 20 | 8 711904 337247 |
| | b.for soft sprayer 0.6l | 762 150 | 10 | 150 425 | 10 | |



B.FOR SOFT WATERING CANS & SPRAYERS TABLE STAND



• to inspire & activate your shopper, order a complete stand with content:

1 metal frame + 2 content = complete concept

1 METAL FRAME STAND (EMPTY)

| art. number | description | size lxd | h | m ² | | ean code |
|-------------------|--------------------------------------|-----------|-----|----------------|---|-----------------|
| 21 000 008 150 30 | watering cans & sprayers table stand | 109 x 109 | 106 | 1.19 | 1 | 8 711904 217204 |

2 PRODUCTS (CONTENT FOR STAND)

| art. number | product | | qty. | | qty. | ean code |
|-------------------|------------------------------|------------|------|------------|------|-----------------|
| 42 000 008 903 10 | b.for soft watering can 1.7l | 360 425 | 10 | 425 150 | 10 | 8 711904 337216 |
| | b.for soft sprayer 0.6l | 425 360 | 10 | 150 425 | 10 | |



| art. number | product | | qty. | | qty. | ean code |
|-------------------|------------------------------|------------|------|------------|------|---------------------|
| 42 000 008 904 10 | b.for soft watering can 1.7l | 150 762 | 10 | 425 150 | 10 | 8 711904 337223 |
| | b.for soft sprayer 0.6l | 762 150 | 10 | 150 425 | 10 | |



AQUARIUS WATERING CANS & SPRAYERS FLOOR STAND

- to inspire & activate your shopper, order a complete stand with content:

1 metal frame + 2 content = complete concept



1 METAL FRAME STAND (EMPTY)

| art. number | description | size lxd | h | m ² | | ean code |
|-------------------|------------------------------------------------|----------|-----|----------------|---|---------------------|
| 21 000 021 150 50 | watering cans & sprayers universal floor stand | 80 x 53 | 198 | 0.42 | 1 | 8 711904 304515 |

2 PRODUCTS (CONTENT FOR STAND)

| art. number | product | | qty. | | qty. | | qty. | | qty. | ean code |
|-------------------|------------------------------|-----|------|-----|------|-----|------|-----|------|---------------------|
| 53 000 011 901 10 | aquarius watering can 1.5ltr | 150 | 10 | 235 | 10 | 397 | 10 | 425 | 10 | 8 711904 306281 |
| | aquarius sprayer 0.7ltr | 150 | 5 | 235 | 5 | 397 | 5 | 425 | 5 | |



AQUARIUS WATERING CANS & SPRAYERS TABLE STAND

- to inspire & activate your shopper, order a complete stand with content:

1 metal frame + 2 content = complete concept



1 METAL FRAME STAND (EMPTY)

| art. number | description | size lxd | h | m ² | | ean code |
|-------------------|--------------------------------------|-----------|-----|----------------|---|---------------------|
| 21 000 008 150 30 | watering cans & sprayers table stand | 109 x 109 | 106 | 1.19 | 1 | 8 711904 217204 |

2 PRODUCTS (CONTENT FOR STAND)

| art. number | product | | qty. | | qty. | | qty. | | qty. | ean code |
|-------------------|------------------------------|-----|------|-----|------|-----|------|-----|------|---------------------|
| 53 000 010 901 10 | aquarius watering can 1.5ltr | 150 | 5 | 235 | 5 | 397 | 5 | 425 | 5 | 8 711904 306274 |
| | aquarius sprayer 0.7ltr | 150 | 5 | 235 | 5 | 397 | 5 | 425 | 5 | |



AQUA CARE TABLE STAND

- to inspire & activate your shopper, order a complete stand with content:

1 metal frame + 2 content = complete concept



1 METAL FRAME STAND (EMPTY)

| art. number | description | size lxd | h | m ² | | ean code |
|-------------------|-----------------------|-----------|-----|----------------|---|-----------------|
| 21 000 016 150 50 | aqua care table stand | 109 x 109 | 106 | 1.19 | 1 | 8 711904 242602 |

2 PRODUCTS (CONTENT FOR STAND)

| art. number | product | | qty. | | qty. | | qty. | ean code |
|-------------------|----------------------|-----|------|-----|------|-----|------|-----------------|
| 21 000 016 901 10 | aqua care (set of 2) | 100 | 16 | 261 | 8 | 366 | 16 | 8 711904 242794 |



GREEN BASICS WATERING CAN FLOOR STAND

- great new stand for proven sales succes: tell our brand story & stimulate the buying impulse!



METAL FRAME STAND (EMPTY)

| art. number | description | size lxd | h | m ² | | ean code |
|-------------------|---------------------------------------------|----------|-----|----------------|---|-----------------|
| 21 938 025 150 50 | green basics watering can metal floor stand | 45 x 57 | 146 | 0.26 | 1 | 8 711904 485658 |

PRODUCTS (CONTENT FOR STAND)

| art. number | product | | qty. | ean code |
|-------------------|-------------------------------|-----|------|-----------------|
| 21 000 022 397 10 | green basics watering can 10l | 397 | 12 | 8 711904 485467 |

| art. number | product | | qty. | ean code |
|-------------------|-------------------------------|-----|------|-----------------|
| 21 000 022 433 10 | green basics watering can 10l | 433 | 12 | 8 711904 485450 |

| art. number | product | | qty. | | qty. | ean code |
|-------------------|-------------------------------|-----|------|-----|------|-----------------|
| 21 000 022 901 10 | green basics watering can 10l | 397 | 6 | 433 | 6 | 8 711904 485474 |



christmas

christmas COLLECTION

Enjoy your Christmas tree with the Christmas tree stands, with a fixator to quickly and easily position the tree upright and prevent from ever falling again. And an water reservoir that ensures the tree looking beautiful and healthy throughout the entire Christmas season. Merry Christmas!



| Description | Ø | ↓ | Ltr | Kg | 📦 | 🚚 | additional information |
|--------------|------|------|-----|------|---|-----|---------------------------------------|
| nordman 39cm | 39.2 | 18.0 | 2.5 | 1.27 | 9 | 216 | water reservoir capacity of 2.5 liter |

| art. number | ean code | art. number | ean code |
|-------------------------|-----------------|-------------------------|-----------------|
| 300 22 418 039 300 02 9 | 8 711904 069919 | 425 22 418 039 425 02 9 | 8 711904 147402 |



| Description | Ø | ↓ | Ltr | Kg | 📦 | 🚚 | additional information |
|--------------|------|------|-----|------|---|----|-------------------------------------|
| nordman 52cm | 51.5 | 20.5 | 5.0 | 2.24 | 6 | 96 | water reservoir capacity of 5 liter |

| art. number | ean code |
|-------------------------|-----------------|
| 300 22 420 052 300 02 6 | 8 711904 069926 |



| Description | Ø | ↓ | Ltr | Kg | 📦 | 🚚 | additional information |
|-------------|------|------|-----|------|---|-----|---------------------------------------|
| oslo 38cm | 37.8 | 17.5 | 1.5 | 0.97 | 8 | 192 | water reservoir capacity of 1.5 liter |

| art. number | ean code |
|-------------------------|-----------------|
| 300 22 518 038 300 03 8 | 8 711904 127718 |

christmas

INSTORE PRESENTATIONS



NORDMAN ISLAND PRESENTATION

- ideal presentation to boost your seasonal sales



| art. number | size lxd | m ² | product | | qty. | ean code |
|-------------------|----------|----------------|--------------|--|------|-----------------|
| 22 000 020 300 10 | 120 x 80 | 0.96 | nordman 39cm | | 126 | 8 711904 072193 |

| art. number | size lxd | m ² | product | | qty. | ean code |
|-------------------|----------|----------------|--------------|--|------|-----------------|
| 22 000 020 425 10 | 120 x 80 | 0.96 | nordman 39cm | | 126 | 8 711904 147778 |

| art. number | size lxd | m ² | product | | qty. | | qty. | ean code |
|-------------------|----------|----------------|--------------|--|------|--|------|-----------------|
| 22 000 020 903 10 | 120 x 80 | 0.96 | nordman 39cm | | 63 | | 63 | 8 711904 147785 |

| art. number | size lxd | m ² | product | | qty. | | qty. | ean code |
|-------------------|----------|----------------|--------------|--|------|--|------|-----------------|
| 22 000 020 904 10 | 120 x 80 | 0.96 | nordman 39cm | | 84 | | 42 | 8 711904 297305 |

| art. number | size lxd | m ² | product | | qty. | ean code |
|-------------------|----------|----------------|--------------|--|------|-----------------|
| 22 000 022 300 10 | 120 x 80 | 0.96 | nordman 39cm | | 63 | 8 711904 072223 |
| | | | nordman 52cm | | 21 | |



OSLO ISLAND PRESENTATION

- ideal presentation to boost your seasonal sales



| art. number | size lxd | m ² | product | | qty. | ean code |
|-------------------|----------|----------------|-----------|--|------|-----------------|
| 22 000 031 300 10 | 120 x 80 | 0.96 | oslo 38cm | | 114 | 8 711904 127817 |



OSLO





how to read

choose the collection and use the scan slider to select the right product

complete with marketing support items



UK

1. select your chapter
2. select your collection
3. select your marketing support
4. all you want to know about your products
5. best place instore

NL

1. selecteer uw hoofdstuk
2. selecteer uw collectie
3. selecteer uw marketingondersteuning
4. alles wat u wilt weten over uw producten
5. beste plek in de winkel

DE

1. Wählen Sie Ihren Abschnitt
2. Wählen Sie Ihre Kollektion
3. Wählen Sie Ihren Marketing-Support
4. Was Sie über Ihre Produkte wissen möchten
5. Verkaufsstärkster Platz im Geschäft

The pages

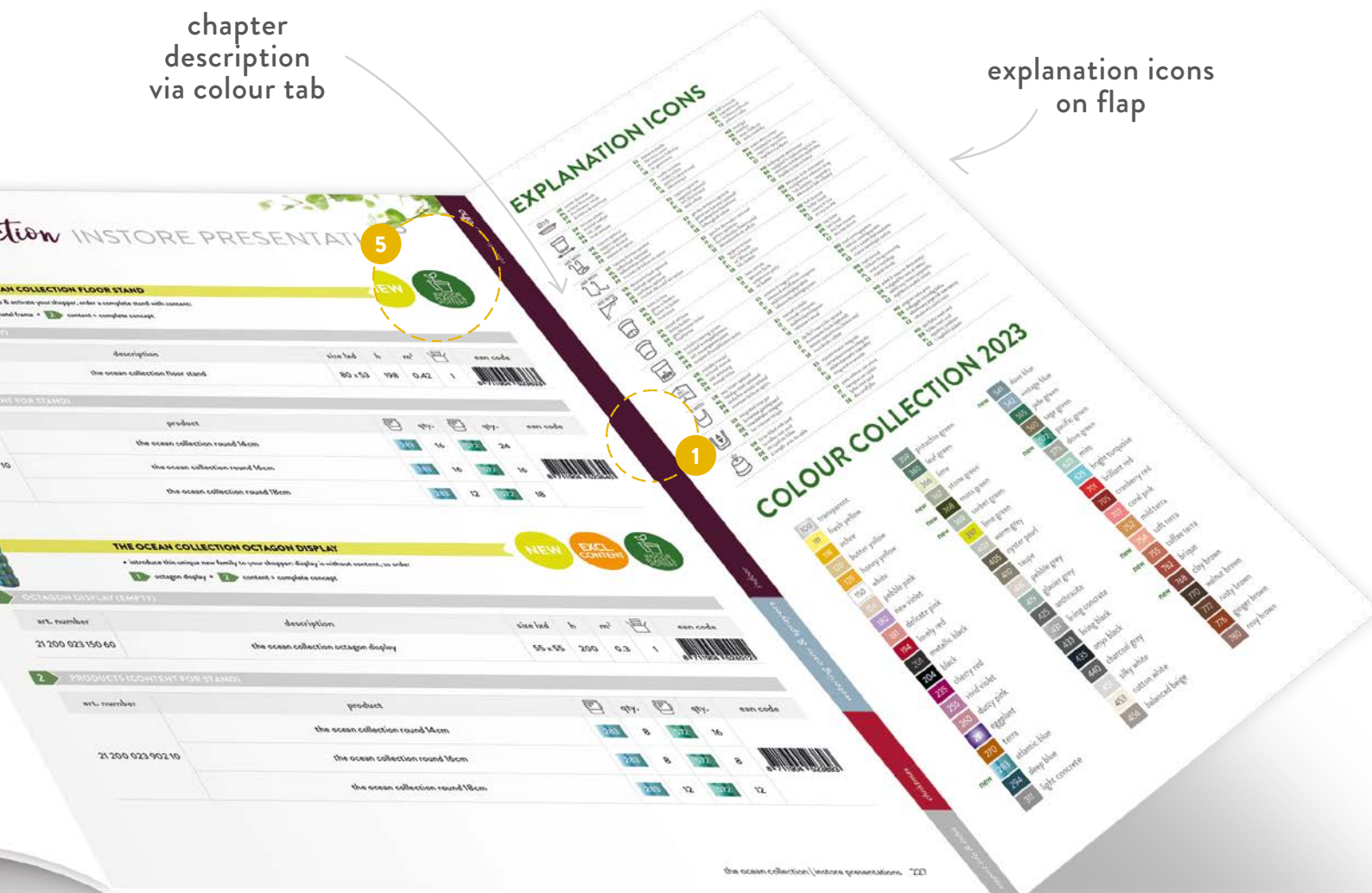

FR

1. sélectionnez votre chapitre
2. sélectionnez votre collectio
3. sélectionnez votre soutien marketing
4. tout ce que vous souhaitez savoir sur vos produits
5. meilleur emplacement en boutique

SE

1. välj din adapter
2. välj din kollektion
3. välj ditt marknadsstöd
4. allt du vill veta om våra produkter
5. bästa platsen i butiken

IT

1. seleziona il capitolo
2. seleziona la collezione
3. seleziona il supporto marketing
4. tutto ciò che desideri sapere sui prodotti
5. zona migliore del negozio





ES

1. elige tu apartado
2. elige tu colección
3. elige tu asistencia de marketing
4. todo lo que quieras saber sobre tus productos
5. mejor sitio en la tienda



BARCELONA

GREEN BASICS

| | | |
|------------------------------------------------------------------------------------------------------------------------------------------------------|-------------------------------------|----------------------------------------|
| <p>barcelona wall bracket</p>  | <p>FOR BARCELONA TROUGH</p> | |
| <p>barcelona balcony bracket</p>  | <p>FOR BARCELONA TROUGH</p> | |
| <p>green basics universal brackets synthetic</p>  | | <p>FOR GREEN BASICS TROUGH</p> |
| <p>green basics wall bracket</p>  | | <p>FOR GREEN BASICS TROUGH</p> |
| <p>green basics balcony bracket</p>  | | <p>FOR GREEN BASICS TROUGH</p> |



balcony supports



BARCELONA

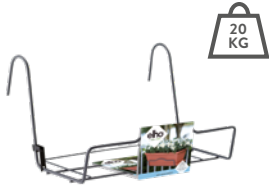
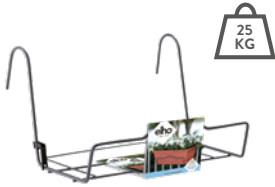

GREEN BASICS

| | | |
|----------------------------------------------------------------------------------------------------------------------|-------------------------------------------------------|----------------------------------------------------------------------|
| <p>balcony support medium</p>  | <p>FOR BARCELONA TROUGH 50CM</p> | |
| <p>balcony support large</p>  | <p>FOR BARCELONA TROUGH 70 & 90CM</p> | |
| <p>green basics balcony rack</p>  | | <p>FOR GREEN BASICS TROUGH 40, 50, 60 & 80CM</p> |

lofturban



loft urban round

loft urban round high

loft urban bowl



loft urban square high

LOFT URBAN SAUCER ROUND

| | | | | |
|------|---------------------|-------|-------|-------|
| 14cm | art. nr. 92 002 214 | ✓ Ø20 | | |
| 17cm | art. nr. 92 024 325 | ✓ Ø25 | | |
| 21cm | art. nr. 92 209 029 | ✓ Ø30 | ✓ Ø28 | |
| 24cm | art. nr. 92 235 033 | | ✓ Ø35 | |
| 28cm | art. nr. 92 277 037 | ✓ Ø40 | | ✓ Ø35 |
| 30cm | art. nr. 92 298 040 | | ✓ Ø42 | |
| 34cm | art. nr. 92 345 046 | ✓ Ø50 | | |
| 41cm | art. nr. 92 353 059 | ✓ Ø60 | | |
| 48cm | art. nr. 92 505 048 | ✓ Ø70 | | |

LOFT URBAN SAUCER SQUARE

| | | |
|------|---------------------|-----------|
| 22cm | art. nr. 92 703 122 | ✓ 30 x 30 |
| 28cm | art. nr. 92 704 128 | ✓ 37 x 37 |

green basics

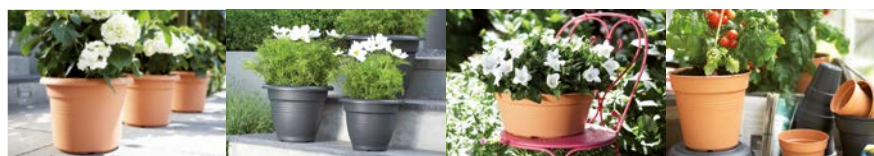

green basics cilinder

green basics campana

green basics bowl

green basics growpot

GREEN BASICS SAUCERS

| | | | | | |
|------|---------------------|-------|----------|-------|------------|
| 10cm | art. nr. 69 902 210 | | | | ✓ Ø11 + 13 |
| 14cm | art. nr. 69 902 214 | | | | ✓ Ø15 + 17 |
| 17cm | art. nr. 69 902 217 | | | | ✓ Ø19 + 21 |
| 22cm | art. nr. 69 903 222 | ✓ Ø25 | ✓ Ø30+35 | | ✓ Ø24 + 27 |
| 25cm | art. nr. 69 904 225 | ✓ Ø30 | ✓ Ø40 | ✓ Ø27 | ✓ Ø30 |
| 29cm | art. nr. 69 904 229 | ✓ Ø35 | | ✓ Ø33 | ✓ Ø35 |
| 34cm | art. nr. 69 905 234 | ✓ Ø40 | ✓ Ø50 | ✓ Ø38 | ✓ Ø40 |
| 41cm | art. nr. 69 906 241 | ✓ Ø45 | | | |
| 45cm | art. nr. 69 906 245 | ✓ Ø55 | | | |
| 53cm | art. nr. 69 906 253 | ✓ Ø65 | | | |
| 65cm | art. nr. 69 907 265 | ✓ Ø80 | | | |

algarve



algarve cilindro



algarve cilindro

UNIVERSAL SAUCER ROUND

| | | |
|------|---------------------|-------|
| 21cm | art. nr. 13 803 121 | ✓ Ø21 |
| 25cm | art. nr. 13 804 125 | ✓ Ø25 |
| 30cm | art. nr. 13 804 130 | ✓ Ø30 |
| 35cm | art. nr. 13 805 135 | ✓ Ø35 |
| 40cm | art. nr. 13 806 140 | ✓ Ø40 |
| 48cm | art. nr. 13 807 148 | ✓ Ø48 |

UNIVERSAL PLANTTAXI

| | | |
|------|---------------------|------------|
| 30cm | art. nr. 64 405 429 | ✓ Ø30 + 35 |
| 35cm | art. nr. 64 405 434 | ✓ Ø40 |
| 40cm | art. nr. 64 405 439 | ✓ Ø48 |

vibia



vibia campana round

vibia campana bowl

vibia straight round



vibia campana square

LOFT URBAN SAUCER ROUND - FOR VIBIA

| | | | | |
|------|---------------------|-------|-------|-------|
| 14cm | art. nr. 92 002 214 | ✓ Ø20 | | |
| 17cm | art. nr. 92 024 325 | ✓ Ø25 | | |
| 21cm | art. nr. 92 209 029 | ✓ Ø30 | | ✓ Ø25 |
| 24cm | art. nr. 92 235 033 | ✓ Ø35 | ✓ Ø27 | |
| 28cm | art. nr. 92 277 037 | ✓ Ø40 | | ✓ Ø30 |
| 30cm | art. nr. 92 298 040 | | ✓ Ø34 | |
| 34cm | art. nr. 92 345 046 | ✓ Ø47 | | ✓ Ø40 |
| 41cm | art. nr. 92 353 059 | ✓ Ø55 | | ✓ Ø47 |
| 48cm | art. nr. 92 505 048 | | | |

LOFT URBAN SAUCER SQUARE - FOR VIBIA

| | | |
|------|---------------------|-----------|
| 22cm | art. nr. 92 703 122 | ✓ 30 x 30 |
| 28cm | art. nr. 92 704 128 | ✓ 37 x 37 |

self-watering insert



pure coupe

pure beads

vibes fold round

the ocean collection

b.for swing

SELF WATERING INSERT

| | | | | | | |
|------|---------------------|-------|---------|-------|-------|-------|
| 17cm | art. nr. 83 162 170 | | | ✓ Ø18 | ✓ Ø18 | ✓ Ø18 |
| 21cm | art. nr. 83 199 210 | | | ✓ Ø22 | ✓ Ø22 | |
| 24cm | art. nr. 83 226 240 | | | ✓ Ø25 | | |
| 28cm | art. nr. 83 260 280 | ✓ Ø35 | ✓ S/M/L | ✓ Ø30 | | |
| 33cm | art. nr. 83 311 330 | ✓ Ø41 | | ✓ Ø35 | | |
| 36cm | art. nr. 83 349 364 | | | | | |
| 44cm | art. nr. 83 398 434 | | | | | |

self-watering insert



b.for original round

b.for soft round

b.for rock

brussels round

brussels hanging basket

brussels diamond round

SELF WATERING INSERT

| | | | | | | | |
|------|---------------------|-------|-------|-------|-------------|-------|-------|
| 17cm | art. nr. 83 162 170 | ✓ Ø18 | ✓ Ø18 | ✓ Ø18 | ✓ Ø18 ✓ Ø20 | ✓ Ø18 | ✓ Ø18 |
| 21cm | art. nr. 83 199 210 | ✓ Ø22 | ✓ Ø22 | | ✓ Ø22 | | ✓ Ø22 |
| 24cm | art. nr. 83 226 240 | ✓ Ø25 | ✓ Ø25 | | ✓ Ø25 | | ✓ Ø25 |
| 28cm | art. nr. 83 260 280 | ✓ Ø30 | ✓ Ø30 | | ✓ Ø30 | | ✓ Ø30 |
| 33cm | art. nr. 83 311 330 | ✓ Ø35 | ✓ Ø35 | | ✓ Ø35 | | |
| 36cm | art. nr. 83 349 364 | | | | ✓ Ø40 | | |
| 44cm | art. nr. 83 398 434 | | | | ✓ Ø47 | | |



Easy to find
YOUR FAVOURITE
PRODUCT



OUTDOOR

NEW COLOUR



GREENSENSE AQUA CARE ROUND

P 40

NEW COLOUR



GREENSENSE AQUA CARE SQUARE

P 41

NEW



VIVO NEXT SQUARE

P 46

NEW



VIVO NEXT LONG

P 46

NEW



VIBIA CAMPANA TROUGH

P 50

NEW



VIBIA CAMPANA TROUGH ALL-IN-1

P 51

NEW



VIBIA CAMPANA DRAINPIPE CLICKER

P 51

NEW COLOUR



VIBIA CAMPANA FLOWER TWIN

P 52

NEW COLOUR



VIBIA CAMPANA FLOWER BRIDGE

P 52

NEW COLOUR



VIBIA CAMPANA EASY HANGER S

P 53

NEW COLOUR



VIBIA CAMPANA EASY HANGER M

P 53

NEW COLOUR



VIBIA CAMPANA EASY HANGER L

P 54

NEW COLOUR



VIBIA CAMPANA VERTICAL FOREST

P 54

NEW COLOUR



VIBIA CAMPANA WALL BASKET

P 55



VIBIA CAMPANA ROUND

P 58



VIBIA CAMPANA BOWL

P 60



VIBIA CAMPANA HANGING BASKET

P 60



VIBIA CAMPANA SQUARE

P 61



VIBIA CAMPANA TERRACE TROUGH

P 61



VIBIA STRAIGHT ROUND

P 64



GREENVILLE TROUGH LONG

P 74



GREENVILLE TERRACE TROUGH

P 74



GREENVILLE ROUND

P 75

NEW COLOUR



GREENVILLE BOWL

P 77



GREENVILLE HANGING BASKET

P 78



GREENVILLE EASY BALCONY

P 78



GREENVILLE EASY HANGER

P 78



LOFT URBAN GREEN WALL POT SINGLE

P 84



LOFT URBAN GREEN WALL POT DUO

P 84



LOFT URBAN GREEN WALL RACK

P 84



LOFT URBAN ROUND

P 85



LOFT URBAN FRAME

P 87



LOFT URBAN ROUND HIGH

P 87



LOFT URBAN BOWL

P 88



LOFT URBAN SAUCER ROUND

P 89



LOFT URBAN SQUARE HIGH

P 92



LOFT URBAN SAUCER SQUARE

P 93



LOFT URBAN TERRACE

P 93



LOFT URBAN TROUGH

P 94



LOFT URBAN TROUGH SAUCER

P 94



LOFT URBAN TROUGH ALL-IN-1

P 94



LOFT URBAN BALCONY POTHOLDER

P 95



LOFT URBAN WALL BASKET

P 95



CORSICA VERTICAL FOREST SMALL

P 100



CORSICA VERTICAL FOREST LARGE

P 100



CORSICA FLOWER BRIDGE 30CM

P 100



CORSICA FLOWER BRIDGE 60CM

P 101



CORSICA EASY HANGER SINGLE

P 101



CORSICA EASY HANGER TRIO

P 101



CORSICA EASY BALCONY

P 102

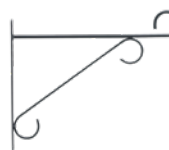

WALL HOOK ELEGANCE

P 102



BARCELONA TROUGH

P 108



BARCELONA TROUGH SAUCER

P 108



BARCELONA WALL BRACKET

P 110



BARCELONA BALCONY BRACKET

P 110



BALCONY SUPPORT

P 110



BARCELONA ALL-IN-1

P 111



BARCELONA XL

P 111



BARCELONA XL SAUCER

P 112



BARCELONA XL ALL-IN-1

P 112



ALGARVE CILINDRO

P 120



ALGARVE TERRACE
WHEELS

P 121



UNIVERSAL SAUCER
ROUND

P 124



UNIVERSAL SAUCER
SQUARE

P 126



UNIVERSAL PLANTTAXI

P 127



UNI-SAUCCER ROUND

P 128



GREEN BASICS BALCONY
POTHOLDER ALL-IN-1

P 138



GREEN BASICS FLOWER
BRIDGE 55CM

P 138



GREEN BASICS EASY
HANGER SMALL

P 138



GREEN BASICS EASY
HANGER LARGE

P 139



GREEN BASICS TROUGH
MINI

P 139



GREEN BASICS TROUGH
MINI ALL-IN-1

P 139



GREEN BASICS TROUGH

P 140



GREEN BASICS TROUGH
SAUCER

P 140



GREEN BASICS BALCONY
RACKS METAL

P 142



GREEN BASICS UNIVERSAL
BRACKETS SYNTHETIC

P 143



GREEN BASICS WALL
BRACKET METAL

P 143



GREEN BASICS BALCONY
BRACKET METAL

P 143



GREEN BASICS TROUGH
ALL-IN-1

P 144



GREEN BASICS TROUGH XL
ALL-IN-1

P 144



GREEN BASICS HANGING
BASKET

P 144



GREEN BASICS CILINDER

P 148



GREEN BASICS CAMPANA

P 149



GREEN BASICS BOWL

P 150



GREEN BASICS SAUCER

P 151



GREEN BASICS GARDEN
XXL

P 154



GREEN BASICS GARDEN
XXL SAUCER

P 154



GREEN BASICS TOP
PLANTER

P 155



GREEN BASICS TOP
PLANTER HIGH

P 156



CARE & GROW

NEW



GREEN BASICS RAINBARREL PLUS

P 166

NEW



GREEN BASICS RAINBARREL DIVERTER

P 166



GREEN BASICS RAIN CATCHER

P 167



GREEN BASICS STACK & GROW

P 167



GREEN BASICS VEGGIE WALL

P 167

NEW

NEW



GREEN BASICS TOMATO POT

P 168



GREEN BASICS POTATO POT

P 168



GREEN BASICS GROWPOT SQUARE ALL-IN-1

P 168



GREEN BASICS GROW TRAY ALL-IN-1

P 169



GREEN BASICS GROW KIT ALL-IN-1

P 170



GREEN BASICS GROW HOUSE

P 170



GREEN BASICS GROW TRAY

P 171



GREEN BASICS GROW TRAY SAUCER

P 172



GREEN BASICS GROW HOUSE ROUND

P 172



GREEN BASICS GROWPOT STARTER SET

P 173



GREEN BASICS GROWPOT

P 173



GREEN BASICS GROWPOT ORCHID

P 176



GREEN BASICS ORCHID SAUCER

P 177



GREEN BASICS GARDEN TRAY

P 177



GREEN BASICS PLANTLABELS

P 178



GREEN BASICS SCOOP

P 178



GREEN BASICS GROW HOUSE XXL

P 179



GREEN BASICS GROW TABLE XXL

P 179

NEW

NEW

NEW

NEW

NEW



NOA GROW TABLE

P 196



BOUNCY BASIL

P 200



MAGIC MICROGREENS

P 200



AMAZING AVOCADO POT

P 200



AMAZING AVOCADO FLOATER

P 201



LEAF LIGHT CARE

P 206



PLANT LIGHT CARE

P 206

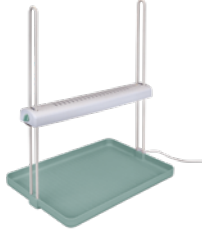

LIGHT GARDEN

P 206

EXCLUSIVES



PURE COUPE

P 212



PURE BEADS SMALL

P 212



PURE BEADS MEDIUM

P 213



PURE BEADS LARGE

P 213



PURE EDGE

P 213



PURE CONE

P 214



PURE CONE HIGH

P 214



PURE SOFT BRICK WHEELS

P 215



PURE SOFT BRICK LONG

P 215



PURE SOFT BRICK DIVIDER

P 216



PURE SOFT BRICK DIVIDER LARGE

P 216



PURE SOFT ROUND

P 216



PURE SOFT ROUND HIGH

P 217



PURE ROUND

P 218



PURE STRAIGHT ROUND

P 220



PURE STRAIGHT ROUND HIGH

P 221



PURE RAINDROP

P 221

INDOOR

NEW



THE OCEAN COLLECTION ROUND

P 230

NEW COLOUR



VIBES FOLD ROUND MINI

P 230

NEW COLOUR



VIBES FOLD ROUND

P 231

NEW



VIBES FOLD COUPE

P 232



B.FOR SWING

P 238



B.FOR SOFT ROUND

P 238



B.FOR SOFT DUO

P 240



B.FOR SOFT AIR

P 240



B.FOR STUDIO ROUND 22CM

P 246



B.FOR STUDIO ROUND
30CM

P 246



B.FOR STUDIO BOWL

P 246

NEW COLOUR



B.FOR ORIGINAL ROUND
MINI

P 250

NEW COLOUR



B.FOR ORIGINAL ROUND

P 251



B.FOR ROCK

P 258



BRUSSELS ROUND MINI

P 262



BRUSSELS ROUND

P 263



BRUSSELS ROUND WHEELS

P 264



BRUSSELS BOWL

P 265



BRUSSELS OVAL

P 265



BRUSSELS HANGING
BASKET

P 266



BRUSSELS DIAMOND
ROUND

P 274



BRUSSELS DIAMOND OVAL

P 276



BRUSSELS DIAMOND
ROUND HIGH

P 276



BRUSSELS DIAMOND HIGH
EASY INSERT

P 277



BRUSSELS DIAMOND
ORCHID HIGH

P 282



BRUSSELS ORCHID HIGH

P 282



BRUSSELS ORCHID DUO

P 282



BRUSSELS ORCHID

P 283



SELF-WATERING INSERT

P 288



FLOORPROTECTOR
ROUND

P 294

WATERING
CANS &
SPRAYERS



BRUSSELS
WATERING CAN

P 301



BRUSSELS
SPRAYER

P 301



B.FOR SOFT
WATERING CAN

P 303



B.FOR SOFT
SPRAYER

P 303



AQUARIUS
WATERING CAN

P 305



AQUARIUS
SPRAYER

P 305



PLUNGE
WATERING CAN

P 307



AQUA CARE

P 309



GREEN BASICS
WATERING CAN

P 311

CHRISTMAS



NORDMAN

P 317



OSLO

P 317

Easy to find

YOUR FAVOURITE STAND OR DISPLAY



OUTDOOR

NEW COLOUR



GREENSENSE AQUA CARE ROUND 30CM DISPLAY

P 42

NEW COLOUR



GREENSENSE AQUA CARE ROUND ISLAND PRESENTATION

P 42



GREENSENSE AQUA CARE SQUARE 30 & 38CM ISLAND PRESENTATION

P 42



VIVO NEXT INSTORE PRESENTATION

P 47

NEW



VIBIA CAMPANA TROUGH ALL-IN-1 50 DISPLAY

P 65

NEW



VIBIA CAMPANA TROUGH ALL-IN-1 70 DISPLAY

P 65

NEW



VIBIA DRAINPIPE CLICKER SHELF-DEMO UNIVERSAL

P 65

NEW COLOUR



VIBIA CAMPANA VERTICAL FOREST DISPLAY

P 66

NEW COLOUR



VIBIA CAMPANA FLOWER TWIN DISPLAY

P 66

NEW COLOUR



VIBIA CAMPANA FLOWER BRIDGE DISPLAY

P 67

NEW COLOUR



VIBIA CAMPANA EASY HANGER SMALL & MEDIUM DISPLAY

P 67

NEW COLOUR



VIBIA CAMPANA EASY HANGER LARGE DISPLAY

P 68



INSPIRATIONAL BALCONY HEADER

P 68



BALCONY SHELF PRESENTATION

P 68



PLANT TABLE BALCONY PRESENTATION

P 68



VIBIA CAMPANA 30CM DISPLAY

P 68



VIBIA CAMPANA ROUND 40 & 47CM ISLAND PRESENTATION

P 70



VIBIA HANGING BASKET SHELF PRESENTATION

P 70



VIBIA STRAIGHT 30CM DISPLAY

P 70



VIBIA STRAIGHT ROUND 40 & 47CM ISLAND PRESENTATION

P 71



GREENVILLE EASY BALCONY DISPLAY

P 79



GREENVILLE 14, 16 & 18CM DISPLAY

P 79



GREENVILLE 30CM DISPLAY

P 80



GREENVILLE 40 & 47CM ISLAND PRESENTATION

P 80



GREENVILLE HANGING BASKET SHELF PRESENTATION

P 81



GREENVILLE PLANT TABLE BALCONY PRESENTATION

P 81

NEW COLOUR



LOFT URBAN GREEN WALL CONCEPT STAND

P 96



LOFT URBAN ROUND 30 DISPLAY

P 96

NEW COMBINATION



CORSICA VERTICAL FOREST SMALL & LARGE DISPLAY

P 103



CORSICA VERTICAL FOREST SHELF PRESENTATION

P 103

NEW COMBINATION



CORSICA FLOWER BRIDGE 30CM DISPLAY

P 103

NEW COMBINATION



CORSICA EASY HANGER DISPLAY

P 104



INSPIRATIONAL BALCONY HEADER

P 104



BALCONY SHELF PRESENTATION

P 104



PLANT TABLE BALCONY PRESENTATION

P 105



UNIVERSAL WALL HOOKS & BRACKETS SHELF PRESENTATION

P 105



BARCELONA BALCONY TROUGH STAND

P 114

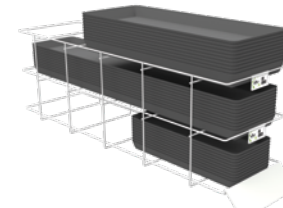

TROUGH SAUCERS IN-SHELF STAND

P 114



INSPIRATIONAL BALCONY HEADER

P 115



BARCELONA TROUGH ALL-IN-1 50CM DISPLAY

P 115



BARCELONA XL ALL-IN-1 55CM DISPLAY

P 116



BALCONY SHELF PRESENTATION

P 116



PLANT TABLE BALCONY PRESENTATION

P 116

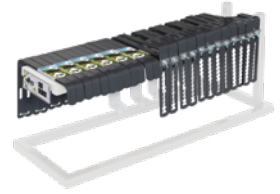

UNIVERSAL WALL HOOKS & BRACKETS SHELF PRESENTATION

P 116

NEW COMBINATION



UNIVERSAL SAUCER STAND 1 SIDED

P 130



UNIVERSAL SAUCER STAND 2 SIDED

P 131



UNIVERSAL PLANT TAXI SHELF PRESENTATION

P 132



SAUCER UNIVERSAL COMPACT SUPPORT STAND

P 132



UNI-Saucer UNIVERSAL COMPACT SUPPORT STAND

P 136



GREEN BASICS BALCONY TROUGH STAND

P 158

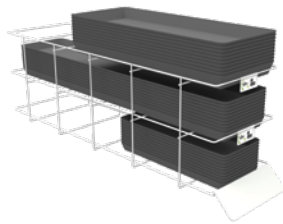

TROUGH SAUCERS IN-SHELF STAND

P 158



GREEN BASICS BALCONY POTHOLDER ALL-IN-1 DISPLAY

P 159



GREEN BASICS EASY HANGER COMBINATION DISPLAY

P 159



GREEN BASICS TROUGH & TROUGH SAUCER DISPLAY

P 159

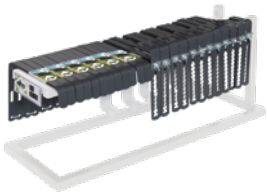

UNIVERSAL WALL HOOKS & BRACKETS SHELF PRESENTATION

P 160



GREEN BASICS TROUGH ALL-IN-1 50CM DISPLAY

P 160



GREEN BASICS TROUGH ALL-IN-1 70CM DISPLAY

P 161



GREEN BASICS TOP PLANTER ISLAND PRESENTATION

P 161





GREEN BASICS GROW YOUR OWN CONCEPT DISPLAY

P 180



GREEN BASICS STACK & GROW LARGE DISPLAY

P 181



GREEN BASICS VEGGIE WALL, TOMATO & POTATO ISLAND PRESENTATION

P 181



GREEN BASICS VEGGIE WALL ISLAND PRESENTATION

P 181



GREEN BASICS GROW YOUR OWN CONCEPT STAND

P 182



GREEN BASICS GROWPOT CONCEPT DISPLAY

P 184



GREEN BASICS GROWPOT CONCEPT STAND

P 188



GREEN BASICS GROWPOT SQUARE ALL-IN-1 STAND

P 189



GREEN BASICS GROWPOT SQUARE ALL-IN-1 DISPLAY

P 190



GREEN BASICS GROWPOT & GROW HOUSE ROUND DISPLAY

P 191



GREEN BASICS GROW TABLE SUPER XXL ISLAND PRESENTATION

P 191



GREEN BASICS GROW TABLE XXL ISLAND PRESENTATION

P 192



GROW YOUR OWN INDOOR FLOOR STAND

P 202



GROW YOUR OWN INDOOR CONCEPT DISPLAY

P 202



AVOCADO FLOATER COUNTER DISPLAY

P 203



LEAF LIGHT CARE TABLE STAND

P 207



INDOOR



THE OCEAN COLLECTION FLOOR STAND

P 227



THE OCEAN COLLECTION OCTAGON DISPLAY

P 227



VIBES MINI UNIVERSAL ROUND TABLE STAND

P 232

NEW COLOUR



VIBES FOLD ROUND MINI DISPLAY

P 232

NEW COLOUR



VIBES INSPIRATIONAL SHELF

P 234

NEW COLOUR



VIBES OCTAGON DISPLAY

P 234



VIBES OCTAGON FLOOR STAND

P 235

NEW



B.FOR SWING DEMO SHELF PRESENTATION

P 242



B.FOR SOFT ROUND UNIVERSAL FLOOR STAND

P 242



B.FOR SOFT AIR SHELF PRESENTATION

P 243

NEW COLOUR



B.FOR ORIGINAL UNIVERSAL FLOOR STAND

P 253

NEW COLOUR



B.FOR ORIGINAL MINI UNIVERSAL ROUND TABLE STAND

P 254

NEW COMBINATION



B.FOR ORIGINAL MINI DISPLAY

P 254

NEW COLOUR



B.FOR ORIGINAL INDOOR DISPLAY

P 255



B.FOR ROCK UNIVERSAL FLOOR STAND

P 259



B.FOR ROCK INDOOR DISPLAY

P 259



BRUSSELS ROUND UNIVERSAL FLOOR STAND

P 268



BRUSSELS ROUND MINI UNIVERSAL TABLE STAND

P 269



BRUSSELS ROUND INDOOR DISPLAY

P 270



BRUSSELS ROUND MINI DISPLAY

P 271



BRUSSELS HANGING BASKET SHELF PRESENTATION

P 271



BRUSSELS DIAMOND ROUND UNIVERSAL FLOOR STAND

P 278



BRUSSELS DIAMOND ROUND INDOOR DISPLAY

P 279



NEW COMBINATION



BRUSSELS ORCHID HIGH & ORCHID DUO UNIVERSAL FLOOR STAND

P 284

NEW COMBINATION



BRUSSELS ORCHID HIGH & ORCHID DUO INDOOR DISPLAY

P 284



TRANSPARENT ORCHID INDOOR DISPLAY

P 285



SELF-WATERING INSERT DISPLAY

P 290

INCL CONTENT



SELF-WATERING INSERT CONCEPT STAND

P 290



FLOORPROTECTOR UNIVERSAL SUPPORT STAND

P 269



WATERING CANS & SPRAYERS



BRUSSELS WATERING CANS & SPRAYERS FLOOR STAND

P 312



BRUSSELS WATERING CANS & SPRAYERS TABLE STAND

P 312



B.FOR SOFT WATERING CANS & SPRAYERS FLOOR STAND

P 313



B.FOR SOFT WATERING CANS & SPRAYERS TABLE STAND

P 313



AQUARIUS WATERING CANS & SPRAYERS FLOOR STAND

P 314



AQUARIUS WATERING CANS & SPRAYERS TABLE STAND

P 314



AQUA CARE TABLE STAND

P 315



GREEN BASICS WATERING CAN FLOOR STAND

P 315



CHRISTMAS



NORDMAN ISLAND PRESENTATION

P 318



OSLO ISLAND PRESENTATION

P 318







koberg

