

colourful

Products

MADE OF
100%
RECYCLED
MATERIALS



koberg



colourful

This unique collection consists of a wide variety of shapes and sizes which can be easily combined with each other. All bins from this collection are produced in the same way. The products are waterproof, frost-resistant and provided with a UV-resistant lacquer. A large part can also be fitted with castor wheels most of which are recessed, so that the wheels are not visible.

SUSTAINABILITY

Colourful products fit seamlessly into the pursuit of a sustainable world. The products in the colourful line are being produced in a fully documented and traceable production process. They are made from recoverable raw materials (polystyrene (PS)) and discarded products are recycled. Production takes place in Germany, resulting in short logistic lines.

NL | Deze unieke collectie bestaat uit een grote diversiteit aan vormen en maten welke onderling goed te combineren zijn. Alle bakken uit deze collectie worden namelijk op dezelfde wijze geproduceerd. De producten zijn waterdicht, vorstbestendig en voorzien van een UV bestendige lak. Ook is een groot deel te voorzien van zwenkwielen waarvan de meeste verzonken, hierdoor zijn de wielen niet zichtbaar.

DUURZAAMHEID

Colourful producten passen naadloos in het streven naar een duurzame wereld. De producten in de Colourful-lijn komen tot stand in een volledig gedocumenteerd en traceerbaar productieproces. Ze worden gemaakt van terugwinbare grondstoffen (polystyrol (PS)) en afgedankte producten worden gerecycled. De productie vindt plaats in Duitsland waardoor sprake is van korte logistieke lijnen.



nibe certificering

In opdracht van Plantinum heeft NIBE een Levenscyclus (hierna LCA) opgesteld van de gerecyclede kunststof plantenbakken serie Colourful .

NIBE is een toonaangevend onafhankelijk adviesbureau in duurzaamheid, expert in het opstellen van LCA's en het inzichtelijk maken van milieu-impact. NIBE adviseert professionals in de bouwsector ambitieuze, realistische, wetenschappelijk onderbouwde duurzaamheidsdoelstellingen vast te stellen en helpt bij het realiseren van hun duurzaamheidsambities.

Een levenscyclus analyse (LCA) is een effectieve, data-gedreven manier om de klimaat- en milieueffecten van een product in de gehele waardeketen te beoordelen. In essentie beantwoordt het de vraag: wat is de milieu impact dat het product heeft op de wereld? Het resultaat van de LCA wordt beschreven in een Environmental Product Declaration (EPD). Dit is een gestandaardiseerd certificaat.

Zie hiernaast de belangrijkste aspecten die in het certificaat naar voren zijn gekomen.

Benieuwd naar de uitgebreide levenscyclus analyse? Neem contact met ons op!

experts in
sustainability
nibe



PRODUCT DESCRIPTION

A container used for plants made from 100% recycled polystyrene. The container can be used in- and outdoor. Jago has a return system in place, encouraging their clients to return their containers after use. The returned containers are used as new raw materials for the next generation recycled containers. The containers have a circularity indicator (MCI) of 64%.

DESCRIPTION OF THE MANUFACTURING PROCESS

Raw materials enter the factory and are stored in the factory. The most important raw materials are polystyrene (recycled granulate) and paint (liquid in cans). The polystyrene granulate is heated in an extruder and injected with a temperature of 200-220 degrees Celsius and under high pressure in a mould. The injection moulding process can take between 40 seconds and 12 minutes, depending on the size of the container. When the process is finished the mould is opened and the container is removed.

When the product is cooled it is finished by hand using tools such as a surface sanding machine. The containers are painted in a spraying machine. The machine is open and the paint spraying is done by hand. The space is suctioned and the air is treated in a filter.

The painted containers are transported to a drying room where they are left to dry for 4 hours up to 10 days. This process is passive and does not require any energy.

The containers are packaged using plastic bags and carton for protection. The product is stacked and placed on a pallet, ready for transport.

- Third party verifier:

Anne Kees Jeeninga, Advieslab

finishes



options

In addition to our 10 standard RAL colours, this collection can be supplied in any colour. A choice can be made between a Structure, Matt or High Shine finish. All used lacquers are water based.

NL | Naast de 10 standaard RAL-kleuren, kan deze collectie in elke gewenste kleur geleverd worden. Er kan een keuze gemaakt worden tussen een structuur, hoogglans en mat afwerking. Alle lakken die gebruikt worden zijn op waterbasis.

colours





Floor planters	10
Staannde plantenbakken	
Hydro planters	58
Hydro plantenbakken	
Cabinet top planters	68
Plantenbakken voor op kasten	
Wall planters	70
Wand plantenbakken	
Hanging planters	84
Hangende plantenbakken	
Room dividers	88
Stands	98
Accessories	110
Accessoires	



floor

planters





21 x 21 x 21

50 x 50 x 50

Outside dim.			Inside dim.			Structure Art.-No.	High Shine Art.-No.	Matt Art.-No.	Rohling Art.-No.	
L	W	H	L	W	D					
40	40	13	38	38	12	110001	111702	112103		
40	40	50	38	38	43	4	111001	111802	112403	
40	40	75	38	38	68	4	112001	111902	112503	113006
40	40	100	38	38	68	4	113001	112002	112603	
40	40	125	38	38	68	4	114001	112102	112703	
40	40	150	38	38	68	4	115001	112202	112803	
50	50	100	48	48	42	4	116001	112302	112913	
50	50	150	48	48	42	4	116401	116442	116543	

Outside dim.			Inside dim.			Structure Art.-No.	High Shine Art.-No.	Matt Art.-No.	Rohling Art.-No.	
L	W	H	L	W	D					
21	21	21	20	20	20	115101	115902	116703	115106	
40	40	40	38	38	34	4	115201	116002	116803	
50	50	50	48	48	43	4	115301	116102	116903	116906
60	60	60	58	58	53	*	115401	116202	117003	
70	70	70	68	68	63	*	115501	116302	117103	
80	80	80	78	78	73	*	115611	116402	117203	
90	90	90	88	88	83	*	115711	116502	117303	
100	100	100	98	98	93	*	115811	116602	117403	

* we recommend using a wheelbase



40 x 40 x 75

50 x 50 x 100

40 x 40 x 125

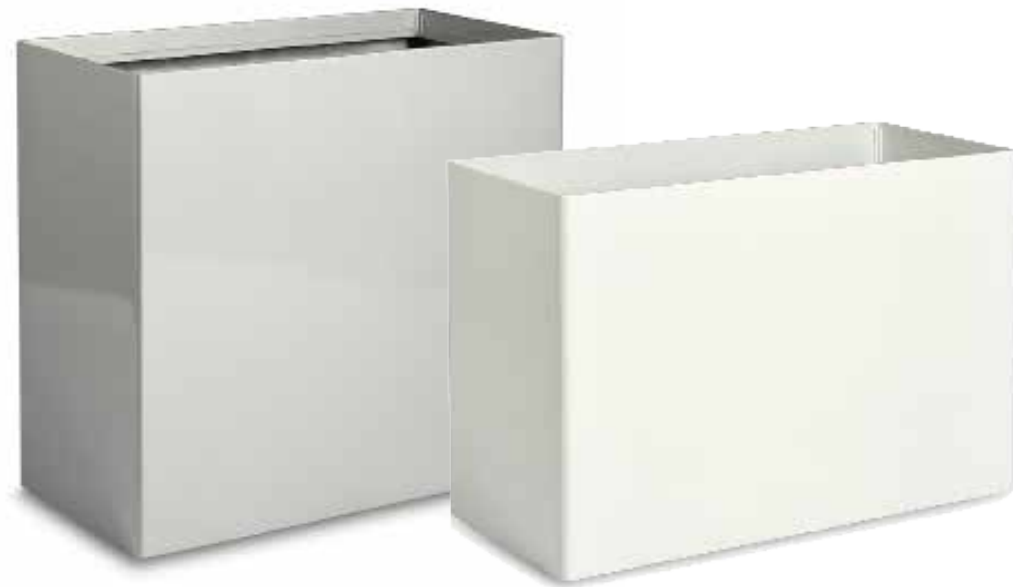

80 x 40 x 75

90 x 40 x 60

Outside Dim.			Inside Dim.			🔗	Structure Art.-No.	High Shine Art.-No.	Matt Art.-No.	Rohling Art.-No.
L	W	H	L	W	D					
90	40	60	88	38	53	8	117711	118002	118303	119506
90	40	75	88	38	53	8	118901	118912	118903	
90	40	120	88	38	53	8	117811	118102	118403	
180	40	60	178	38	53	16	117911	118212	118503	
80	40	75	78	38	68	8	113601	114302	114903	
120	40	75	118	38	34	8	113701	114402	115003	
160	40	75	158	38	34	10	113801	114502	115103	
200	40	75	198	38	34	12	113901	114602	115203	
100	50	50	98	48	43	8	114011	114702	115303	
150	50	50	148	48	43	12	114101	114802	115403	
200	50	50	198	48	43	16	114201	114902	115503	
120	40	24	118	38	18	8	255721	256822	256923	

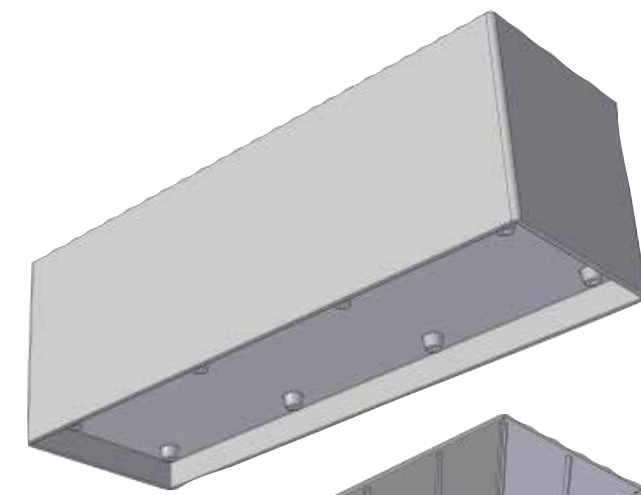

120 x 40 x 40 / Hidden wheels

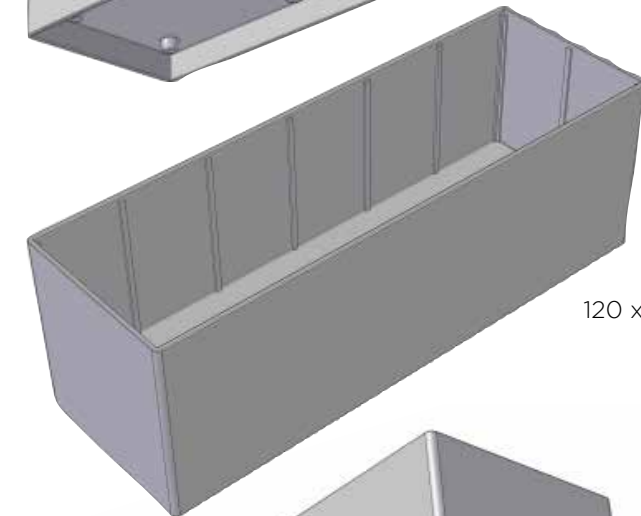

120 x 40 x 36 / Flat bottom

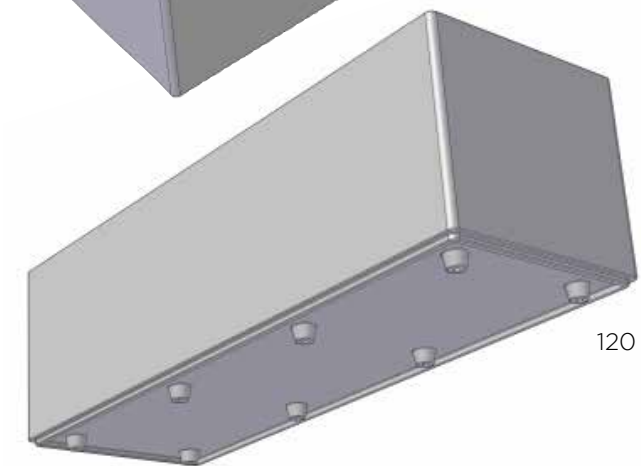

120 x 40 x 37 / Stackable

3 TYPES RECTANGULAR 120 X 40

Outside Dim.			Inside Dim.			🔗	Structure Art.-No.	High Shine Art.-No.	Matt Art.-No.	Rohling Art.-No.
L	W	H	L	W	D					
120	40	40	118	38	33	8	114411	114412	114413	114416
120	40	37	118	38	34	8	114421	114422	114423	114426
120	40	36	118	38	34		114431	114432	114433	114436



50 x 50 x 50

Outside Dim.			Inside Dim.			🔩	Structure	High Shine	Matt	Rohling
L	W	H	L	W	D		Art.-No.	Art.-No.	Art.-No.	Art.-No.
40	40	13	30	30	12		113911	113702	114403	
40	40	50	30	30	43	4	113101	113802	114503	
40	40	75	30	30	68	4	113201	113902	114603	
40	40	100	30	30	68	4	113301	114002	114703	
40	40	125	30	30	68	4	113401	114102	114803	
40	40	150	30	30	68	4	113501	114202	114913	
50	50	100	40	40	43	4	113611	114312	115113	
50	50	150	40	40	43	4	116441	116452	116553	

Outside Dim.			Inside Dim.			🔩	Structure	High Shine	Matt	Rohling
L	W	H	L	W	D		Art.-No.	Art.-No.	Art.-No.	Art.-No.
40	40	40	30	30	34	4	117501	118202	112903	
50	50	50	40	40	43	4	117601	118302	113003	
60	60	60	50	50	53	*	117701	118402	113103	
70	70	70	60	60	63	*	117801	118502	113203	
80	80	80	70	70	73	*	117901	112602	113303	
90	90	90	80	80	83	*	118001	112702	113403	
100	100	100	90	90	93	*	118101	112802	113503	

* we recommend using a wheelbase



40 x 40 x 75



90 x 40 x 60

80 x 40 x 75

Outside Dim.			Inside Dim.			Structure Art.-No.	High Shine Art.-No.	Matt Art.-No.	Rohling Art.-No.
L	W	H	L	W	D				
80	40	75	70	30	68	8	115601	116312	117123
120	40	75	110	30	34	8	115701	116412	117113
160	40	75	150	30	34	10	115801	116512	117213
200	40	75	190	30	34	12	115901	116612	117313
100	50	50	90	40	43	8	116301	116702	117413
150	50	50	140	40	43	12	116101	116802	117503
200	50	50	190	40	43	16	116201	116902	117603
90	40	60	80	30	53	8	118601	118902	119203
90	40	75	80	30	53	8	119001	119202	119903
90	40	120	80	30	53	8	118701	119002	119303
180	40	60	178	38	53	12	118801	119102	119403

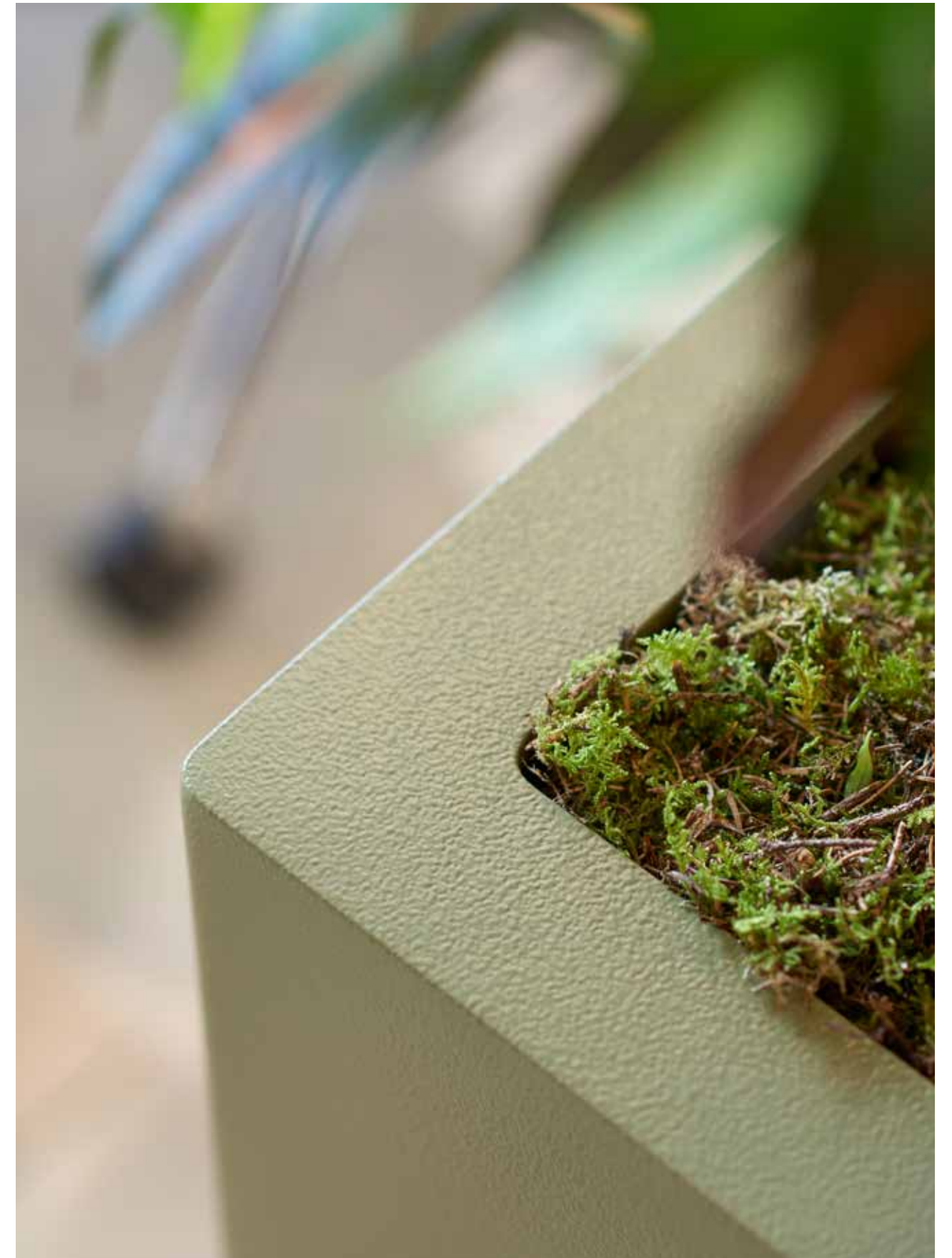

PROMO

Outside Dim.			Inside Dim.			Structure Art.-No.	High Shine Art.-No.	Matt Art.-No.	Rohling Art.-No.	
L	W	H	L	W	D					
30	30	56	28	28	46	4	131001	131402	131803	131006
35	35	40	34	34	33	4	131101	131502	131903	
40	40	75	38	38	68	4	131201	131602	132003	132806
40	40	131	38	38	68	4	131301	131702	132103	



Promo Plus 40 x 40 x 75



Promo 40 x 40 x 75

PROMO PLUS

Outside Dim.			Inside Dim.			Structure Art.-No.	High Shine Art.-No.	Matt Art.-No.	Rohling Art.-No.	
L	W	H	L	W	D					
30	30	56	27	27	49	4	132101	132302	132503	
40	40	75	30	30	68	4	132201	132402	132603	

STAR

Outside Dim.			Inside Dim.			Structure Art.-No.	High Shine Art.-No.	Matt Art.-No.	Rohling Art.-No.
L	W	H	L	W	D				
39	39	80	30	30	73	4	132901	133002	133103



Pri-Star 43 x 80 x 41



Pri-Twin Star 43 x 80 x 41

TWIN STAR

Outside Dim.			Inside Dim.			Structure Art.-No.	High Shine Art.-No.	Matt Art.-No.	Rohling Art.-No.
L	W	H	L	W	D				
36	36	80	34	34	32	4	133201	133302	133403



Star 39 x 39 x 80



Twin Star 36 x 36 x 80

PRI-STAR

Outside Dim.		Inside Dim.		Structure Art.-No.	High Shine Art.-No.	Matt Art.-No.	Rohling Art.-No.
Ø	H	Ø	D				
43	80	41	72	4	126201	126302	126403

PRI-TWIN STAR

Outside Dim.		Inside Dim.		Structure Art.-No.	High Shine Art.-No.	Matt Art.-No.	Rohling Art.-No.
Ø	H	Ø	D				
43	80	41	72	4	126501	126602	126703



“
GREEN FINGERS
ARE THE EXTENSION
OF A VERDANT HEART

PRIMUS

Outside Dim.		Inside Dim.		Structure Art.-No.	High Shine Art.-No.	Matt Art.-No.	Rohling Art.-No.
Ø	H	Ø	D				
33	56	32	49	4	121001	121602	122203
40	40	39	33	4	121101	121702	122403
43	75	43	68	4	121201	121802	122503
37,5	95	36,5	31	4	121211	121812	122513
43	131	12	68	4	121301	121902	122603
50	112	49	41	4	121401	122002	122703
50	172	49	41	4	121501	122102	122803

PRIMUS PLUS

Outside Dim.		Inside Dim.		Structure Art.-No.	High Shine Art.-No.	Matt Art.-No.	Rohling Art.-No.
Ø	H	Ø	D				
33	56	29	49	4	122901	123402	123903
37,5	95	27,5	31	4	121231	121832	122533
43	75	33	68	4	123001	123502	124003
43	131	33	68	4	123101	123602	124103
50	112	40	41	4	123201	123702	124203
50	172	40	41	4	123301	123802	124303



PRIMUS UPSIDEDOWN

Outside Dim.		Inside Dim.		Structure Art.-No.	High Shine Art.-No.	Matt Art.-No.	Rohling Art.-No.
Ø	H	Ø	D				
33	116	31	104	4	124401	124702	125003
26	131	25	62	4	124501	124802	125103
26	172	25	63	4	124601	124902	125203

PRIMUS PLUS UPSIDEDOWN

Outside Dim.		Inside Dim.		Structure Art.-No.	High Shine Art.-No.	Matt Art.-No.	Rohling Art.-No.
Ø	H	Ø	D				
33	116	28	104	4	125301	125602	125903
26	131	21	62	4	125401	125702	126003
26	172	21	63	4	125501	125802	126103



26 x 131



26 x 131

PAREL

Outside Dim.		Inside Dim.		Structure Art.-No.	High Shine Art.-No.	Matt Art.-No.	Rohling Art.-No.	
Ø	H	Ø	D					
37	36	35	29	3	261001	261602	262203	261166
43	39	41	32	4	261101	261702	262303	261176
50	39	46	32	4	261301	261902	262503	261156
60	53	59	44	4	261401	262002	262603	261196
70	53	69	44	5	261501	262102	262703	261206



43 x 39



37 x 36

50 x 39

60 x 53

PAREL PLUS

Outside Dim.		Inside Dim.		Structure Art.-No.	High Shine Art.-No.	Matt Art.-No.	Rohling Art.-No.
Ø	H	Ø	D				
37	36	26	29	3	261801	263102	263503
43	39	33	31	4	262801	263202	263603
50	39	38	31	4	262901	263302	263703
60	53	45	43	4	263001	263402	263803
70	53	53	43	5	263101	263502	263903



43 x 117

PAREL PLUS PEDESTALS

Outside Dim.		Inside Dim.		Structure Art.-No.	High Shine Art.-No.	Matt Art.-No.	Rohling Art.-No.
Ø	H	Ø	D				
37	75	26	68	4	267301	268402	269503
37	111	26	30	4	267401	268502	269603
37	150	26	68	4	267501	268602	269703
43	78	33	32	4	267601	268702	269803
43	117	33	32	4	267701	268802	269903
43	156	33	32	4	267801	268902	261013
50	78	38	32	4	267901	269002	261113
50	117	38	32	4	268001	269102	261123
50	156	38	32	4	268101	269202	261133
60	103	46	43	4	268201	269302	261143
60	155	46	43	4	268301	269402	261153

PAREL PEDESTALS

Outside Dim.		Inside Dim.		Structure Art.-No.	High Shine Art.-No.	Matt Art.-No.	Rohling Art.-No.
Ø	H	Ø	D				
37	75	36	68	4	264001	265102	266203
37	111	36	29	4	264101	265202	266303
37	150	36	68	4	264201	265302	266403
43	78	41	32	4	264301	265402	266503
43	117	41	32	4	264401	265502	266603
43	156	41	32	4	264501	265602	266703
50	78	47	32	4	264601	265702	266803
50	117	47	32	4	264701	265802	266903
50	156	47	32	4	264801	265902	267003
60	103	58	43	4	264901	266002	267103
60	155	58	43	4	265001	266102	267203



37 x 75



TOP

Outside Dim.		Inside Dim.		🔗	Structure Art.-No.	High Shine Art.-No.	Matt Art.-No.	Rohling Art.-No.
Ø	H	Ø	D					
43	40	41	33	4	151001	151302	151603	151006
43	65	41	58	4	151901	152802	153703	
43	79	41	32	4	152001	152902	153803	
43	103	41	32	4	152101	153002	153903	
43	118	41	32	4	152201	153102	154003	
50	47	48	40	4	151101	151402	151703	151106
50	70	48	62	4	152301	153202	154103	
50	116	48	46	4	152401	153302	154203	
60	57	58	50	4	151201	151502	151803	151206
60	81	58	74	4	152501	153402	154303	
60	110	58	45	4	152601	153502	154403	
60	163	58	45	4	152701	153602	154503	

TOP PLUS

Outside Dim.		Inside Dim.		🔗	Structure Art.-No.	High Shine Art.-No.	Matt Art.-No.	Rohling Art.-No.
Ø	H	Ø	D					
43	40	32	33	4	154601	156102	157203	
43	65	32	58	4	154701	156202	157303	
43	79	32	32	4	154801	156302	157403	
43	103	32	32	4	154901	156402	157503	
43	118	32	32	4	155001	156502	157603	
50	47	35	40	4	155101	156602	157703	
50	70	35	62	4	155201	156612	157803	
50	116	35	46	4	155601	156702	157903	
60	57	46	50	4	155701	156802	158003	
60	81	46	74	4	155801	156902	158103	
60	110	46	45	4	155901	157002	158203	
60	163	46	45	4	156001	157102	158303	



43 x 79

50 x 70



DUAL TOP

Outside Dim.		Inside Dim.		Structure Art.-No.	High Shine Art.-No.	Matt Art.-No.	Rohling Art.-No.
Ø	H	Ø	D				
43	40	29	33	4	141001	142202	143403
43	60	29	53	4	141101	142302	143503
43	81	29	73	4	141201	142402	143603
43	119	29	64	4	141301	142502	143703
50	44	38	37	4	141401	142602	143803
50	64	38	57	4	141501	142702	143903
50	93	38	86	4	141601	142802	144003
60	65	47	58	4	141701	142902	144103
60	90	47	83	4	141801	143002	144203
60	114	47	107	4	141901	143102	144303
60	138	47	89	4	142001	143202	144403
60	167	47	105	4	142101	143302	144503

DROP

Outside Dim.		Inside Dim.		Structure Art.-No.	High Shine Art.-No.	Matt Art.-No.	Rohling Art.-No.
Ø	H	Ø	D				
43	68	36	61	4	161401	161702	162003
43	115	32	108	4	161501	161802	162103
50	160	32	75	4	161601	161902	162203



43 x 115



43 x 115

REDROP

Outside Dim.		Inside Dim.		Structure Art.-No.	High Shine Art.-No.	Matt Art.-No.	Rohling Art.-No.
Ø	H	Ø	D				
43	115	29	108	4	161001	161202	161303
50	160	38	84	4	161101	161302	161403

CASCARA

Outside Dim.		Inside Dim.		Structure Art.-No.	High Shine Art.-No.	Matt Art.-No.	Rohling Art.-No.
Ø	H	Ø	D				
40	20	39	19	221001	221302	221603	221906
43	22	42	21	221101	221402	221703	222006
50	25	49	24	221201	221502	221803	221206



50 x 25



43 x 22

CASCARA BALL

Outside Dim.		Inside Dim.		Structure Art.-No.	High Shine Art.-No.	Matt Art.-No.	Rohling Art.-No.
Ø	H	Ø	D				
40	36	24	35	222801	223102	223303	
43	40	25	39	222901	223202	223403	
50	45	28	44	223001	223302	223503	



50 x 45

CASCARA PLUS

Outside Dim.		Inside Dim.		Structure Art.-No.	High Shine Art.-No.	Matt Art.-No.	Rohling Art.-No.
Ø	H	Ø	D				
40	20	22	19	221901	222202	222503	
43	22	35	21	222001	222302	222603	
50	25	42	24	222101	222402	222703	



50 x 25

VOLENDAM

Outside Dim.			Inside Dim.			Structure Art.-No.	High Shine Art.-No.	Matt Art.-No.	Rohling Art.-No.
L	W	H	L	W	D				
62	19	12	61	18	11	241001	241102	241203	



AMSTERDAM

Outside Dim.			Inside Dim.			Structure Art.-No.	High Shine Art.-No.	Matt Art.-No.	Rohling Art.-No.
L	W	H	L	W	D				
68	20	22	67	19	19	241301	241402	241503	241606



UTRECHT

Outside Dim.			Inside Dim.			Structure Art.-No.	High Shine Art.-No.	Matt Art.-No.	Rohling Art.-No.
L	W	H	L	W	D				
68	20	41	45	10	40	241901	242002	242103	



AMSTERDAM PLUS

Outside Dim.			Inside Dim.			Structure Art.-No.	High Shine Art.-No.	Matt Art.-No.	Rohling Art.-No.
L	W	H	L	W	D				
68	20	22	62	14	19	241601	241702	241803	





ALKMAAR

Outside Dim.			Inside Dim.			Structure Art.-No.	High Shine Art.-No.	Matt Art.-No.	Rohling Art.-No.
L	W	H	L	W	D				
68	20	32	62	18	29	242501	242502	242503	



ROTTERDAM

Outside Dim.			Inside Dim.			Structure Art.-No.	High Shine Art.-No.	Matt Art.-No.	Rohling Art.-No.
L	W	H	L	W	D				
68	20	38	62	18	35	242201	242302	242403	



ALKMAAR PLUS

Outside Dim.			Inside Dim.			Structure Art.-No.	High Shine Art.-No.	Matt Art.-No.	Rohling Art.-No.
L	W	H	L	W	D				
68	20	32	58	15	29	242601	242702	242803	





Rome 43 x 51

ROME

Outside Dim.		Inside Dim.		Structure Art.-No.	High Shine Art.-No.	Matt Art.-No.	Rohling Art.-No.
Ø	H	Ø	D				
43	51	29	50	4	171001	171202	171403
50	66	33	57	4	171101	171302	171503

LONDON

Outside Dim.		Inside Dim.		Structure Art.-No.	High Shine Art.-No.	Matt Art.-No.	Rohling Art.-No.
Ø	H	Ø	D				
50	125	34	28	4	181001	181102	181203

LONDON PLUS

Outside Dim.		Inside Dim.		Structure Art.-No.	High Shine Art.-No.	Matt Art.-No.	Rohling Art.-No.
Ø	H	Ø	D				
50	125	32	38	4	181301	181402	181503



London
50 x 125

PARIS

Outside Dim.		Inside Dim.		Structure Art.-No.	High Shine Art.-No.	Matt Art.-No.	Rohling Art.-No.
Ø	H	Ø	D				
50	140	34	36	4	191001	191102	192003

PARIS PLUS

Outside Dim.		Inside Dim.		Structure Art.-No.	High Shine Art.-No.	Matt Art.-No.	Rohling Art.-No.
Ø	H	Ø	D				
50	140	32	36	4	192701	192802	192903



PARIS UPSIDE DOWN

Outside Dim.		Inside Dim.		Structure Art.-No.	High Shine Art.-No.	Matt Art.-No.	Rohling Art.-No.
Ø	H	Ø	D				
50	140	34	36	4	192101	192202	192303

PARIS PLUS UPSIDE DOWN

Outside Dim.		Inside Dim.		Structure Art.-No.	High Shine Art.-No.	Matt Art.-No.	Rohling Art.-No.
Ø	H	Ø	D				
50	140	42	40	4	192401	192502	192603

CHAPEAU

SMALL

Outside Dim.		Inside Dim.		Structure	High Shine	Matt	Rohling	
Ø	H	Ø	D					Art.-No.
48	60	26-47	53	4	281001	281102	281203	283106

LARGE

Outside Dim.		Inside Dim.		Structure	High Shine	Matt	Rohling	
Ø	H	Ø	D					Art.-No.
69	60	26-69	53	4	281301	281402	281503	283206

SPAIN

Outside Dim.		Inside Dim.		Structure	High Shine	Matt	Rohling	
Ø	H	Ø	D					Art.-No.
69	120	26-69	53	4	281601	281702	281803	

DENMARK

Outside Dim.		Inside Dim.		Structure	High Shine	Matt	Rohling	
Ø	H	Ø	D					Art.-No.
69	137	26-69	130	4	281901	282002	282103	



Spain



Small



Denmark



Large

CHAPEAU

FRANCE

Outside Dim.		Inside Dim.		Structure Art.-No.	High Shine Art.-No.	Matt Art.-No.	Rohling Art.-No.
Ø	H	Ø	D				
69	162	26-69	53	4	282501	282602	282703

SWEDEN

Outside Dim.		Inside Dim.		Structure Art.-No.	High Shine Art.-No.	Matt Art.-No.	Rohling Art.-No.
Ø	H	Ø	D				
69	190	26-69	53	4	282801	282902	283003

ENGLAND

Outside Dim.		Inside Dim.		Structure Art.-No.	High Shine Art.-No.	Matt Art.-No.	Rohling Art.-No.
Ø	H	Ø	D				
69	137	26-69	53	4	282201	282302	282403



60 x 61



60 x 100



France



Sweden



England

MUSHROOM

Outside Dim.		Inside Dim.		Structure Art.-No.	High Shine Art.-No.	Matt Art.-No.	Rohling Art.-No.
Ø	H	Ø	D				
60	61	59	22	4	286611	286612	286613
60	85	59	22	4	286851	286852	286853
60	100	59	22	4	286101	286102	286103

COCKTAIL

Outside Dim.		Inside Dim.		Structure Art.-No.	High Shine Art.-No.	Matt Art.-No.	Rohling Art.-No.
Ø	H	Ø	D				
50	69	50	36	126811	126912	127013	



CHAMPAGNE PLUS

Outside Dim.		Inside Dim.		Structure Art.-No.	High Shine Art.-No.	Matt Art.-No.	Rohling Art.-No.
Ø	H	Ø	D				
43	98	33	67	126801	126902	127003	



BLACKBERRY PLUS

Outside Dim.		Inside Dim.		Structure Art.-No.	High Shine Art.-No.	Matt Art.-No.	Rohling Art.-No.
Ø	H	Ø	D				
50	100	40	22	133501	133602	133703	



JADECO PLUS

Outside Dim.		Inside Dim.		Structure Art.-No.	High Shine Art.-No.	Matt Art.-No.	Rohling Art.-No.
Ø	H	Ø	D				
60	147	46	23	4	133801	133902	134003



MIGO

Outside Dim.			Inside Dim.			Structure Art.-No.	High Shine Art.-No.	Matt Art.-No.	Rohling Art.-No.
L	W	H	L	W	D				
37	21	40	35	20	37	158401	158502	158603	
45	29	46	43	28	37	158701	158802	158903	



ZIGO

Outside Dim.			Inside Dim.			Structure Art.-No.	High Shine Art.-No.	Matt Art.-No.	Rohling Art.-No.
L	W	H	L	W	D				
42	20	40	41	19	40	159001	159102	159203	
50	31	46	49	29	32	158301	158402	158503	



SPACE SAVER

Outside Dim.			Inside Dim.			Structure Art.-No.	High Shine Art.-No.	Matt Art.-No.	Rohling Art.-No.
L	W	H	L	W	D				
43	21	40	41	21	34	158601	158702	158803	
50	23	47	48	22	41	158901	159002	159103	
60	30	57	58	29	50	159201	159302	159403	





hydro
planters

MULTIVORM ROUND

Outside Dim.		Inside Dim.		Structure Art.-No.	High Shine Art.-No.	Matt Art.-No.	Rohling Art.-No.
Ø	H	Ø	D				
24	23	24	21	251101	251802	252503	251106
30	14	29	12	251001	251702	252403	
30	25	30	23	3	251201	251902	252606
37	25	37	23	3	251301	252002	251606
50	25	50	23	4	251401	252102	251406
60	25	60	22	4	251501	252202	253706
70	25	70	22	4	251601	252302	254006



30 x 25



37 x 25



50 x 25

MULTIVORM ROUND BOWL

Outside Dim.		Inside Dim.		Structure Art.-No.	High Shine Art.-No.	Matt Art.-No.	Rohling Art.-No.
Ø	H	Ø	D				
37	15	36	14	251331	252032	252733	
50	15	49	14	251431	252132	252833	
60	15	59	14	251531	252232	252933	

MULTIVORM RECTANGULAR

Outside Dim.			Inside Dim.			Structure Art.-No.	High Shine Art.-No.	Matt Art.-No.	Rohling Art.-No.	
L	W	H	L	W	D					
40	20	14	39	19	12		254801	255902	257003	254806
60	20	14	59	49	12		254901	256002	257103	254906
70	25	14	69	24	12	4	255001	256102	257203	
53,5	18,5	14,5	53	18	14	4	259201	259202	259203	259206
70	25	22	69	24	22	4	255101	256202	257303	257306
80	20	23	79	19	22	4	255201	256302	257403	255206
50	35	25	48	34	22	4	255401	256502	257603	255406
60	35	25	59	34	22	4	255501	256602	257703	255506
70	35	25	69	34	22	4	255601	256702	257803	255606
90	35	25	89	34	22	4	255701	256802	257903	255706

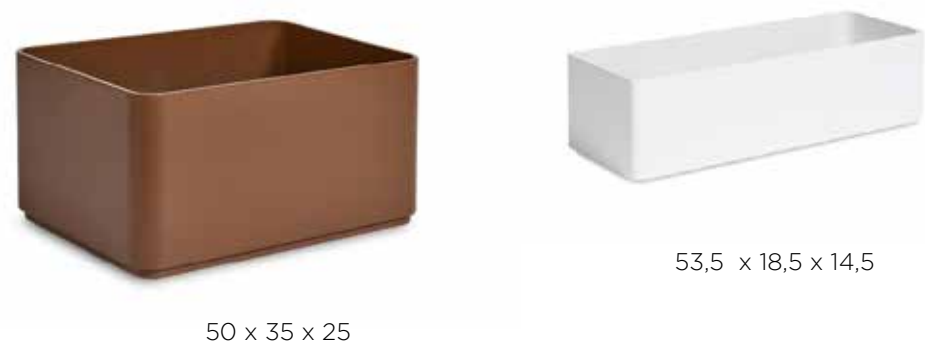

MULTIVORM RECTANGULAR BOWL

Outside Dim.			Inside Dim.			Structure Art.-No.	High Shine Art.-No.	Matt Art.-No.	Rohling Art.-No.
L	W	H	L	W	D				
80	20	15	79	19	14	255231	256332	257433	
70	35	15	69	34	14	255631	256732	257833	
90	35	15	89	34	14	255731	256832	257933	



MULTIVORM SQUARE

Outside Dim.			Inside Dim.			Structure Art.-No.	High Shine Art.-No.	Matt Art.-No.	Rohling Art.-No.	
L	W	H	L	W	D					
20	20	14	19	19	13	253101	253702	254203	253106	
35	35	25	34	34	23	4	253201	253802	254303	253306
40	40	25	39	39	23	4	253301	253902	254403	255306
50	50	25	48	48	23	4	253401	253912	254503	254606
60	60	25	59	59	23	4	253501	254012	254603	256606
70	70	25	69	69	23	4	253601	254112	254703	253606

MULTIVORM SQUARE BOWL

Outside Dim.			Inside Dim.			Structure Art.-No.	High Shine Art.-No.	Matt Art.-No.	Rohling Art.-No.
L	W	H	L	W	D				
40	40	15	39	39	14	253331	259932	254433	
50	50	15	49	49	14	253431	254432	254533	
60	60	15	59	59	14	253531	254032	254633	



Multivorm Square
35 x 35 x 25



Multivorm Square Bowl
40 x 40 x 15

3 TYPES RECTANGULAR 80 X 30

Outside Dim.			Inside Dim.			Structure Art.-No.	High Shine Art.-No.	Matt Art.-No.	Rohling Art.-No.
L	W	H	L	W	D				
80	30	22	78	28	21,5	119511	119512	119513	
80	30	23	78	28	21,5	119521	119522	119523	119526
80	30	29	78	28	21,5	119501	119502	119503	119536

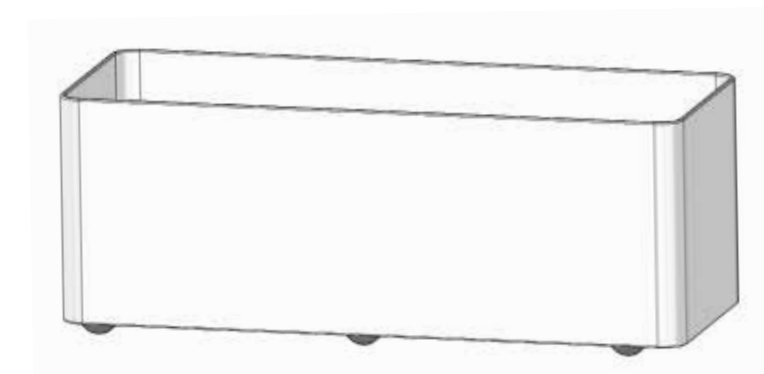

Platin Rectangular 80 x 30 x 29

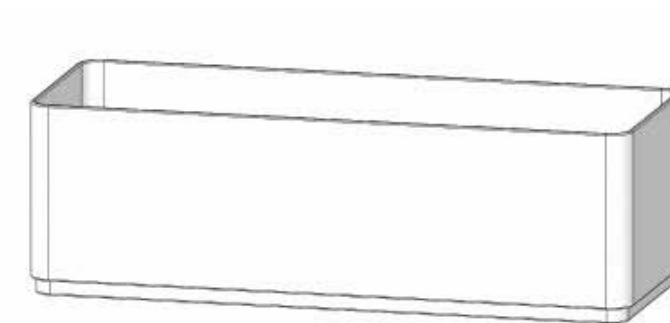

Multivorm Rectangular (stackable)
80x30x23



Platin Rectangular (flat bottom)
80 x 30 x 22



MULTIVORM HEXAGOON

Outside Dim.		Inside Dim.		Structure Art.-No.	High Shine	Matt	Rohling
Ø	H	Ø	D		Art.-No.	Art.-No.	Art.-No.
65	24	64	22	258101	258302	258703	258706
70	24	69	22	258201	258602	258803	258806



65 x 24

MULTIVORM QUARTER AROUND

Outside Dim.		Inside Dim.		Structure Art.-No.	High Shine	Matt	Rohling
Ø	H	Ø	D		Art.-No.	Art.-No.	Art.-No.
50	24	49	22	258901	259002	259103	259106



50 x 24

cabinet

top planters



Cabinet Top Planter 120 x 40 x 25

PRESTIGE CABINET TOP PLANTER

Outside Dim.			Structure	High Shine	Matt	Rohling
L	W	H	Art.-No.	Art.-No.	Art.-No.	Art.-No.
90	40	25	117721	117722	117723	
120	40	25	114441	114442	114443	
160	40	25	113811	113812	113813	
120	40	36	114431	114432	114433	114436



wall
planters



MULTIVORM

Outside Dim.			Inside Dim.			Structure Art.-No.	High Shine Art.-No.	Matt Art.-No.	Rohling Art.-No.
L	W	H	L	W	D				
20	20	14	19	19	13	255111	255112	255113	
40	20	14	39	19	12	255121	255122	255123	
60	20	14	59	19	12	255131	255132	255133	
80	20	22	79	19	21	255141	255142	255143	
70	25	22	69	24	22	255151	255152	255153	



80 x 20 x 24



60 x 20 x 14



20 x 20 x 14

PRESTIGE

Outside Dim.			Inside Dim.			Structure Art.-No.	High Shine Art.-No.	Matt Art.-No.	Rohling Art.-No.
L	W	H	L	W	D				
21	21	21	20	20	20	115821	115822	115823	
40	20	75	38	18	68	112011	111912	112513	



40 x 20 x 75



21 x 21 x 21



PROMO

Outside Dim.			Inside Dim.			Structure	High Shine	Matt	Rohling
L	W	H	L	W	D	Art.-No.	Art.-No.	Art.-No.	Art.-No.
30	15	56	29	14	49	131011	131412	131813	
40	20	75	38	18	68	131211	131612	132013	



PRIMUS

Outside Dim.		Inside Dim.		Structure	High Shine	Matt	Rohling
Ø	H	Ø	D	Art.-No.	Art.-No.	Art.-No.	Art.-No.
33	56	32	49	121011	121612	122213	
43	75	42	68	122211	122812	125513	

PROMO ANGLE

Outside Dim.			Inside Dim.			Structure	High Shine	Matt	Rohling
L	W	H	L	W	D	Art.-No.	Art.-No.	Art.-No.	Art.-No.
30	30	48	29	29	47	131021	131022	131023	
40	40	64	39	39	63	131221	131222	131223	

PRIMUS ANGLE

Outside Dim.		Inside Dim.		Structure	High Shine	Matt	Rohling
Ø	H	Ø	D	Art.-No.	Art.-No.	Art.-No.	Art.-No.
33	53	32	49	121021	121022	121023	
43	71	42	68	121221	121222	121223	



Promo 40 x 20 x 75

Primus 33 x 56

PRESTIGE ANGLE

Outside Dim.			Inside Dim.			Structure	High Shine	Matt	Rohling
L	W	H	L	W	D	Art.-No.	Art.-No.	Art.-No.	Art.-No.
40	40	64	39	39	63	112021	112022	112023	



50 x 16,5



CASCARA

Outside Dim.		Inside Dim.		Structure	High Shine	Matt	Rohling
Ø	H	Ø	D	Art.-No.	Art.-No.	Art.-No.	Art.-No.
40	20	39	19	221031	221332	221633	
43	22	41	21	221131	221432	221733	
50	25	49	24	221231	221532	221833	



Cascara 50 x 25

MULTIVORM ROUND

Outside Dim.		Inside Dim.		Structure	High Shine	Matt	Rohling
Ø	H	Ø	D	Art.-No.	Art.-No.	Art.-No.	Art.-No.
37	16,5	36	14	251311	252012	252713	
50	16,5	49	14	251411	252112	252813	
60	16,5	59	14	251511	252212	252913	
70	16,5	69	14	251611	252312	253013	

MULTIVORM SQUARE

Outside Dim.			Inside Dim.			Structure Art.-No.	High Shine Art.-No.	Matt Art.-No.	Rohling Art.-No.
L	W	H	L	W	D				
40	40	16,5	39	39	14	253311	259912	254413	
50	50	16,5	49	49	14	253411	254412	254513	



Square 40 x 40 x 16,5

MULTIVORM RECTANGULAR

Outside Dim.			Inside Dim.			Structure Art.-No.	High Shine Art.-No.	Matt Art.-No.	Rohling Art.-No.
L	W	H	L	W	D				
70	35	16,5	69	34	14	252721	252722	252723	
90	35	16,5	89	34	14	252821	252822	252823	



MULTIVORM QUARTER AROUND

Outside Dim.		Inside Dim.		Structure Art.-No.	High Shine Art.-No.	Matt Art.-No.	Rohling Art.-No.
Ø	H	Ø	D				
50	16,5	48	14	258911	259012	259113	



MULTIVORM HEXAGOON

Outside Dim.		Inside Dim.		Structure Art.-No.	High Shine Art.-No.	Matt Art.-No.	Rohling Art.-No.
Ø	H	Ø	D				
40	16,5	39	14	248211	248612	248813	
55	16,5	54	14	247211	247612	247813	
65	16,5	64	14	258111	258112	258123	
70	16,5	69	14	258211	258612	258813	



50 x 6

MULTIVORM MOSSFRAME INCL HANGING SYSTEM

Outside Dim.		Inside Dim.		Structure	High Shine	Matt	Rohling
Ø	H	Ø	D	Art.-No.	Art.-No.	Art.-No.	Art.-No.
37	6	35	5	258001	258012	258013	
50	6	48	5	258021	258022	258023	
60	6	58	5	258031	258032	258033	
70	6	68	5	258041	258042	258043	

MULTIVORM MOSSFRAME EXCL HANGING SYSTEM

Outside Dim.		Inside Dim.		Structure	High Shine	Matt	Rohling
Ø	H	Ø	D	Art.-No.	Art.-No.	Art.-No.	Art.-No.
37	6	35	5	259001	259112	259013	
50	6	48	5	259021	259122	259123	
60	6	58	5	259031	259132	259033	
70	6	68	5	259041	259142	259043	



back mounting



METAL MOSSFRAME ROUND

Outside Dim.		Inside Dim.		White	Graphite
Ø	H	Ø	D	Art.-No.	Art.-No.
70	6	69	5	136710	136711
90	6	89	5	136910	136911
110	6	109	5	136110	136111



METAL MOSSFRAME SQUARE

Outside Dim.			Inside Dim.			White	Graphite
L	W	H	L	W	D	Art.-No.	Art.-No.
60	60	6	59	59	5	136610	136611
80	80	6	79	79	5	136810	136811
100	100	6	99	99	5	136100	136101



Including:
Prestige Sideboard 120x40x36
+ K-plate
+ Multivorm Square 35x35x25

HANGING DRAWER

Outside Dim.			Inside Dim.			Structure	High Shine	Matt	Rohling
L	W	H	L	W	D	Art.-No.	Art.-No.	Art.-No.	Art.-No.
120	40	36	34	34	24	120401	120402	120403	



hanging way

planters

MULTIVORM HANGING

Outside Dim.			Inside Dim.			Structure	High Shine	Matt	Rohling
L	W	H	L	W	H	Art.-No.	Art.-No.	Art.-No.	Art.-No.
20	20	14	19	19	13	252221	252222	252223	
40	20	14	39	19	12	252321	252322	252323	
60	20	14	59	49	12	252421	252422	252423	
70	25	22	69	24	22	252621	252622	252623	
80	20	22	79	19	22	252521	252522	252523	
35	35	24	34	34	23	252921	252922	252923	
40	40	24	39	39	23	254101	254102	254103	
50	50	24	48	48	23	254201	254202	254803	
60	60	24	58	58	23	254301	254302	254903	



! Hanging Wire not included

Hanging Multivorm
Round 37x22



Hanging Cascara 50x25

! Hanging Wire not included

MULTIVORM ROUND HANGING

Outside Dim.		Inside Dim.		Structure	High Shine	Matt	Rohling
Ø	H	Ø	D	Art.-No.	Art.-No.	Art.-No.	Art.-No.
30	22	29	21	251221	251222	251223	
37	22	36	21	251321	251322	251323	
50	22	49	21	251421	251422	251423	
60	22	59	21	251521	251522	251523	

CASCARA HANGING

Outside Dim.		Inside Dim.		Structure	High Shine	Matt	Rohling
Ø	H	Ø	D	Art.-No.	Art.-No.	Art.-No.	Art.-No.
40	20	39	19	221001	221312	221613	
43	22	42	21	221111	221412	221713	
50	25	49	24	221211	221512	221813	



tik tak

room dividers

TIK TAK

SINGLE SIDED

Outside Dim.			Structure	High Shine	Matt	Rohling	Amount
L	W	H	Art.-No.	Art.-No.	Art.-No.	Art.-No.	plants
90	40	180	280101	280102	280103		36



Tik Tak Two Sided
96 plants

Round Wall Tik Tak Plus
8 plants

ROUND WALL

TIK TAK PLUS

Outside Dim.		Structure	High Shine	Matt	Rohling	Amount
Ø	H	Art.-No.	Art.-No.	Art.-No.	Art.-No.	plants
50	11	280311	280312	280313		2
99	11	280321	280322	280323		8



! Wheels available on request

! Wheels available on request



Tik Tak Two Sided
72 plants



Tik Tak Two Sided
96 plants

TIK TAK TWO SIDED

Outside Dim.			Structure	High Shine	Matt	Rohling	Amount plants
L	W	H	Art.-No.	Art.-No.	Art.-No.	Art.-No.	
90	40	180	280201	280202	280203		72
90	40	190	281311	281302	281303		96
90	40	200	280301	280302	280303		108



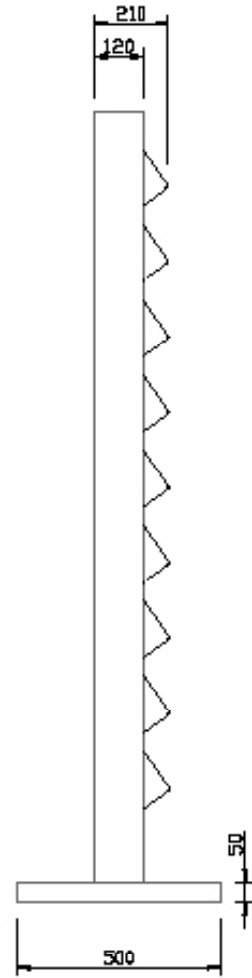

! Wheels available on request

ONE SIDED BLACK ALU

Outside Dim.			Art.-No.	Amount plants
L	W	H		
100	50	180	117004	54
130	50	180	117005	72

ONE SIDED CUSTOM BLACK ALU

Outside Dim.			Art.-No.	Amount plants
L	W	H		
150	50	215	117006	64

ONE SIDED CUSTOM WHITE ALU

Outside Dim.			Art.-No.	Amount plants
L	W	H		
150	50	215	117007	64

! Wheels available on request

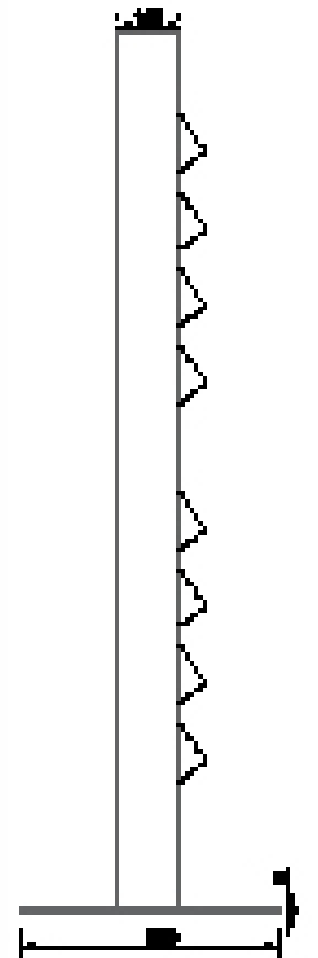

ROOM DIVIDER

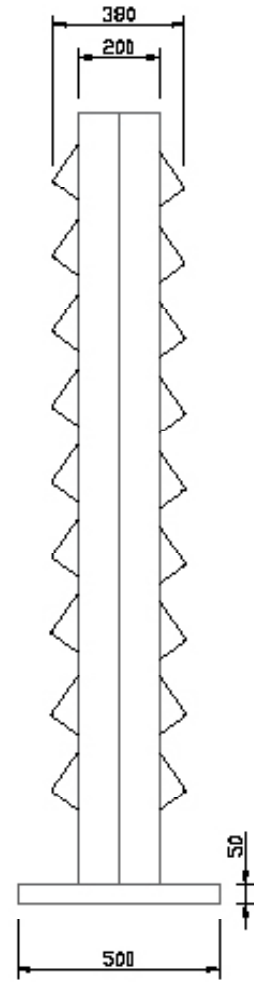

! Wheels available on request

TWO SIDED BLACK ALU

Outside Dim.			Art.-No.	Amount plants
L	W	H		
100	50	180	117104	108
130	50	180	117105	144

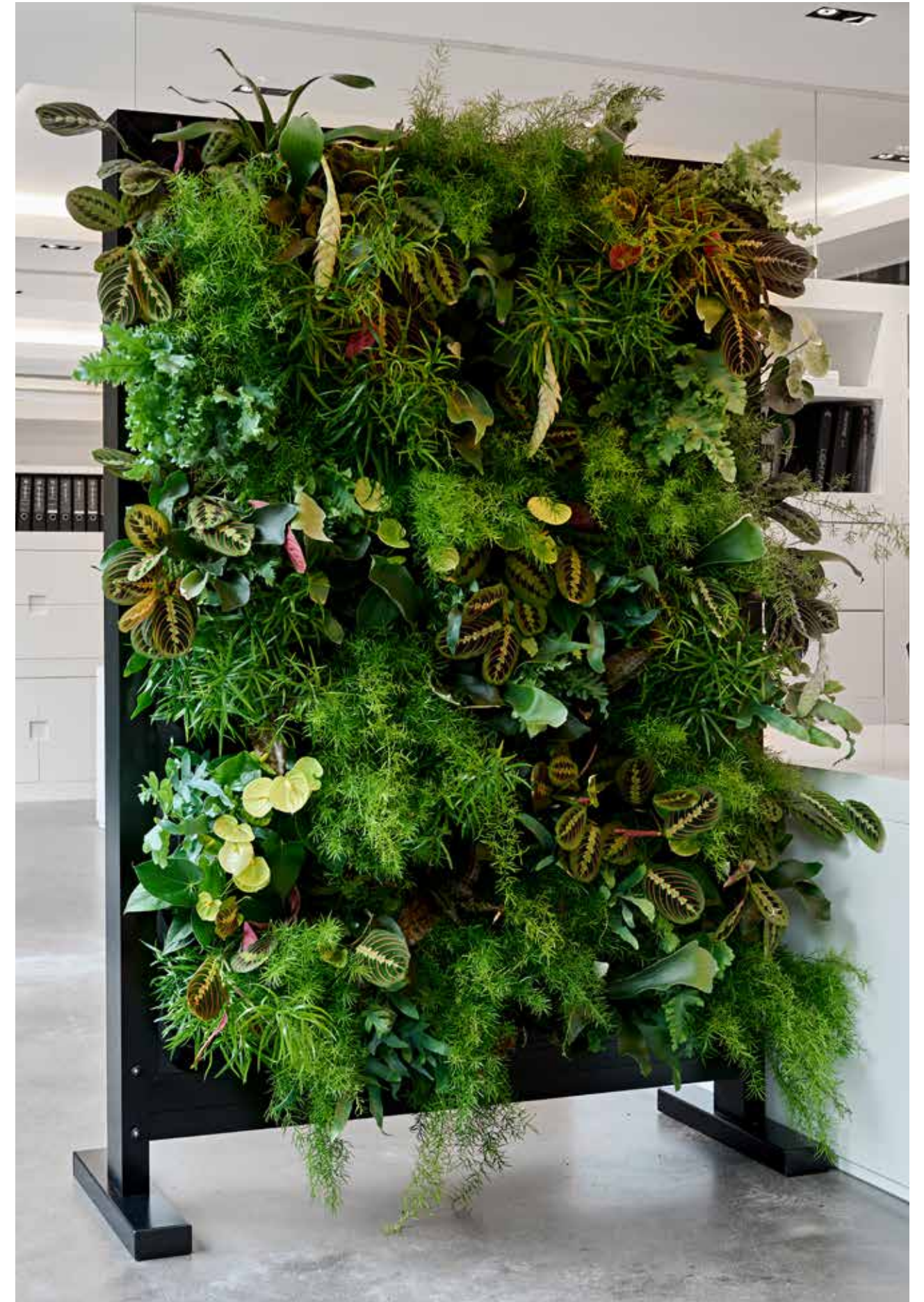



planter
stands

STAND ALONE

ROUND

Outside Dim.		Industrial	Matt Black	Suitable for
Ø	H	Art.-No.	Art.-No.	
38,5	96	700111	700121	Parel 37x36 & Parel 37x75
52	55	700112	700122	Parel 50x39
58	50	700109	700110	Parel 60x53



! Planter not included



STAND ALONE

RECTANGULAR

Outside Dim.			Industrial	Matt Black	Suitable for
L	W	H	Art.-No.	Art.-No.	
90	40	48	700162	700163	Prestige Rectangular 90x40x60

RECTANGULAR STAND

Outside Dim.			Industrial	Matt Black	Suitable for
L	W	H	Art.-No.	Art.-No.	
53	34	68	700115	700125	Multivorm 60x35x25
83	34	68	700116	700126	Multivorm 90x35x25
120	40	41	700158	700159	Prestige Rectangular (stackable) 120x40x37
120	40	66	700160	700161	Prestige Rectangular (stackable) 120x40x37



! Planter not included



TRIANGLE STAND

Outside Dim.			Industrial	Matt Black	Suitable for
L	W	H	Art.-No.	Art.-No.	
80	20	42	700117	700127	Multivorm 80x20x24

MODERN ROUND STAND

Outside Dim.		White	Matt Black	Suitable for
Ø	H	Art.-No.	Art.-No.	
37	38	700107	700108	Multivorm Round 37x25
37	52	700137	700138	Multivorm Round 37x25
50	29	700105	700106	Multivorm Round 50x25
60	17	700103	700104	Multivorm Round 60x25

! Planter not included





! Planter not included

DIVISIBLE STAND

Inside Dim.			Industrial	Matt Black	Suitable for
L	W	H	Art.-No.	Art.-No.	
34	34	40	700140	700141	Parel 37x36
34	34	65	700142	700143	Parel 37x36
34	34	100	700144	700145	Parel 37x36
50	50	40	700146	700147	Parel 50x39
50	50	65	700148	700149	Parel 50x39
50	50	100	700150	700151	Parel 50x39



DANISH INDUSTRIAL

Inside Dim.			Industrial	Suitable for
L	W	H	Art.-No.	
125	48	205	700500	3 x Primus 33x56

! Additional wooden plate available for another level with 3 Primus planters



! Planters not included





planter

ACCES SORIES

INSERT PLATE

SQUARE

L	W	H	Art.-No.	Suitable for
38	38	1	290004	Prestige 40x40x75
34	34	1	290034	Promo 40x40x75
30	30	1	290006	Promo 30x30x56



RECTANGULAR

L	W	H	Art.-No.	Suitable for
87	34	1	290005	Prestige 90x40x60



ROUND

Ø	H	Art.-No.	Suitable for
36	1	290007	Primus Ø 43x75



SYNTHETIC INSERTS

L	W	H	Ø	Art.-No.
86	36	30		290010
		15	25	290251
		22	30	290301
		25	35	290351
		30	40	290401
		35	45	290451
		38	50	290501
		45	60	290601
		45	70	290701
		60	80	290801



WHEELS

H	Art.-No.
40	299999
50	290001



HANGING WIRES

L	Art.-No.	Suitable for
60	700001	Round Bowl
80	700002	Round Bowl
100	700010	Round Bowl
150	700003	Round Bowl
100	700014	Square Bowl
120	700004	Square Bowl
150	700005	Square Bowl
120	700006	Rectangular Bowl
150	700007	Rectangular Bowl



HANGING CHAINS

L	Art.-No.	Suitable for
60	700008	Round Bowl
80	700009	Round Bowl
120	700011	Round Bowl
150	700013	Round Bowl

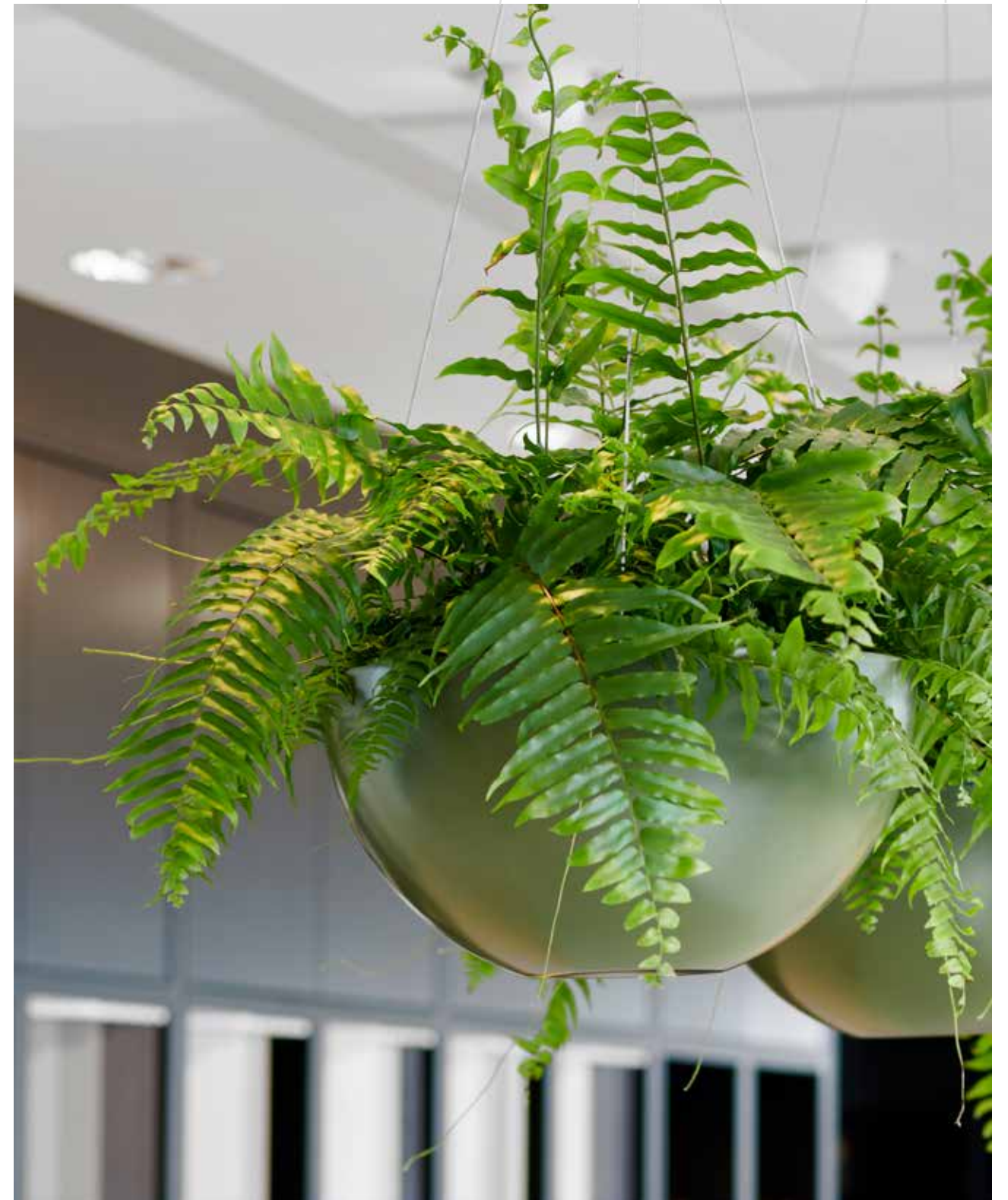



Koberg B.V.
Klappolder 178 - 180 | 2665 MP Bleiswijk | The Netherlands
T: +31 (0)10-529 6555
www.koberg.nl | info@koberg.nl

2023